

Chip Inductors

(Chip Coils)

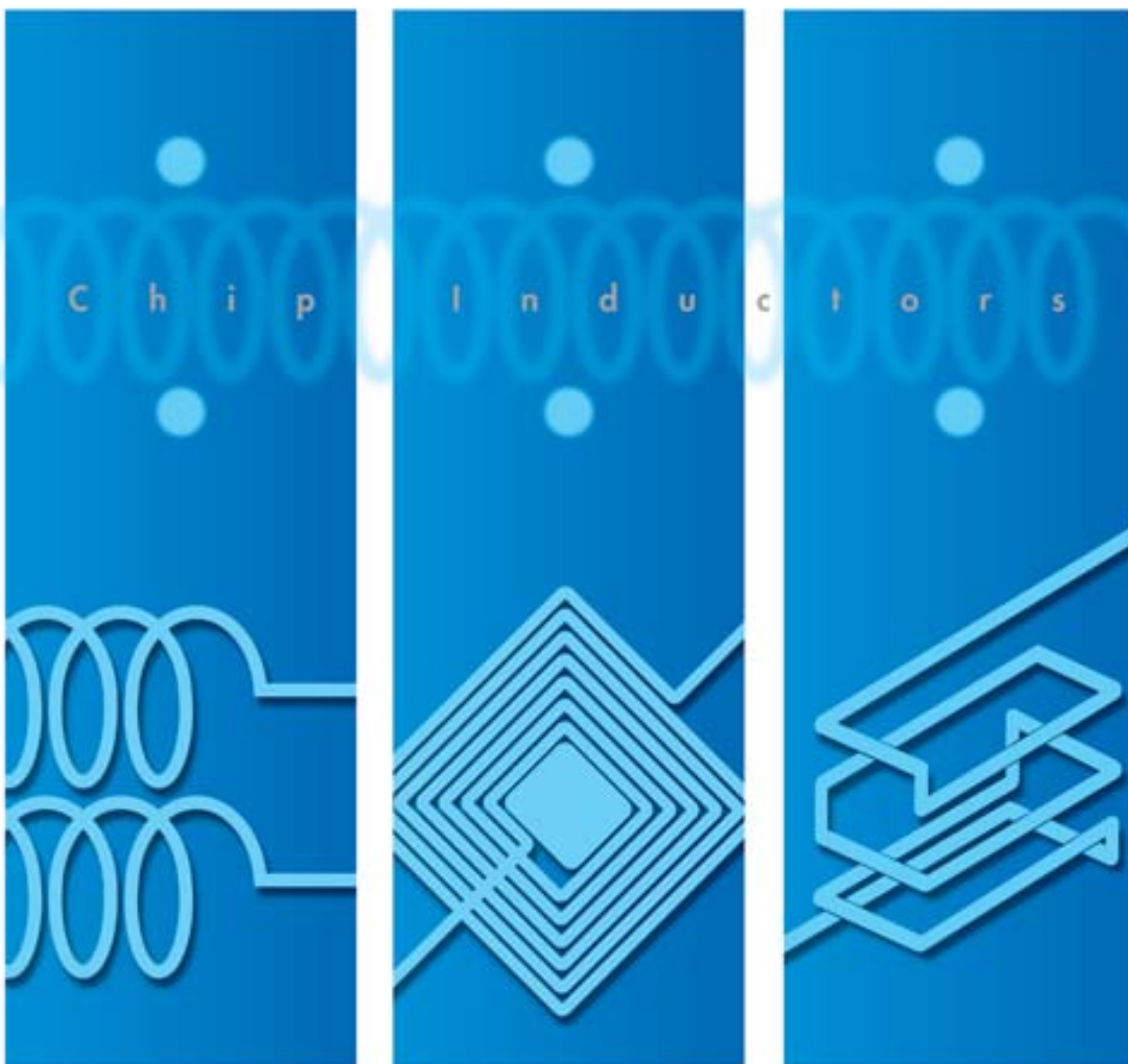

*Innovator
in Electronics*

**Murata
Manufacturing Co., Ltd.**

⚠Note • Please read rating and ⚠CAUTION (for storage, operating, rating, soldering, mounting and handling) in this catalog to prevent smoking and/or burning, etc.
• This catalog has only typical specifications. Therefore, please approve our product specifications or transact the approval sheet for product specifications before ordering.

O05E.pdf
Nov.25,2013

Introduction

Murata has various chip inductors for every application such as power circuits and high frequency circuits.

There are 3 types of structure: wirewound, multilayer, and film.

These variations enable the best selection for every user's needs.

We will support customers using material technologies and highly developed design technologies.

Explanation of symbols in this catalog

Features of each series



New product



Reflow soldering applicable



Flow soldering applicable



Max height xxmm



Low DC resistance type



Bias current characteristics improved



E12 step inductance variation



E24 step inductance variation



Hi Q type



Tight inductance tolerance available

Features of each item



New product



Design kit available

EU RoHS Compliant

- All the products in this catalog comply with EU RoHS.
- EU RoHS is "the European Directive 2011/65/EU on the Restriction of the Use of Certain Hazardous Substances in Electrical and Electronic Equipment."
- For more details, please refer to our website 'Murata's Approach for EU RoHS' (<http://www.murata.com/info/rohs.html>).

CONTENTS

Classification and Structure of Chip Inductors	2
Product Guide	4
Selection Guide	8
Product Guide by Thickness	9

• Inductors for Power Lines

Introduction	12
Part Numbering	14
Product Detail	16
⚠Caution/Notice	100
Soldering and Mounting	102
Packaging	107
Design Kits	111

• Inductors for General Use

Part Numbering	118
Product Detail	119
⚠Caution/Notice	136
Soldering and Mounting	137
Packaging	141
Design Kits	142

• RF Inductors







Introduction	146
Part Numbering	147
Product Detail	148
⚠Caution/Notice	225
Soldering and Mounting	227
Packaging	231
Design Kits	232

Part Number Quick Reference	243	
Introduction of Web Site	Design Tools	244
	EMICON-FUN!	245
	Products Information	246



Classification and Structure of Chip Inductors

Line Up and Applications for Chip Inductors

	Line Up	Applications
For Power Lines / For Low Frequency Circuits (Under 100MHz)	Wire Wound Type Ferrite Core  LQH Series (With some exceptions.)	For Voltage Conversion For Choke For Resonance Circuits For Low Frequency Filter Circuits
	Multilayer Type Ferrite Core  LQM Series	
RF Inductors (Greater than 100MHz)	Wire Wound Type Ferrite Core for High Frequency  LQW_H Series LQH_H Series	For Impedance Matching For High Frequency Filter Circuits For RF Choke
	Wire Wound Type Non-magnetic Core  LQW_A Series	
	Multilayer Type Non-magnetic Material  LQG Series	
	Film Type Non-magnetic Material  LQP Series	

Construction and Features of Chip Inductors

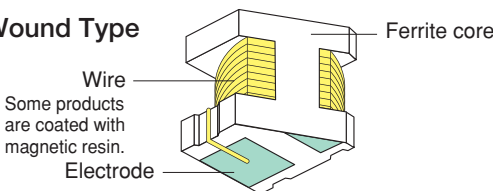
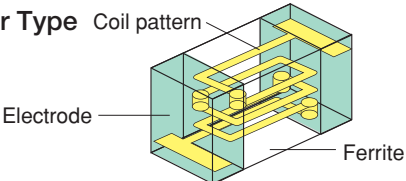
	Construction	Features
For Power Lines / For General Circuits	Wire Wound Type  Ferrite core Wire Some products are coated with magnetic resin. Electrode	Wide inductance range Good DC bias current characteristics Small and lightweight Low DC resistance
	Multilayer Type  Coil pattern Electrode Ferrite	

⚠Note • Please read rating and ⚠CAUTION (for storage, operating, rating, soldering, mounting and handling) in this catalog to prevent smoking and/or burning, etc.
• This catalog has only typical specifications. Therefore, please approve our product specifications or transact the approval sheet for product specifications before ordering.

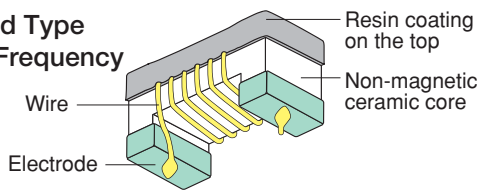
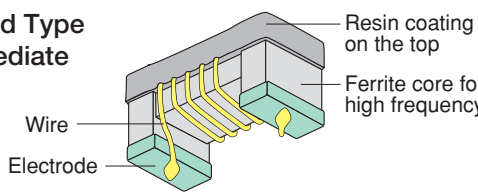
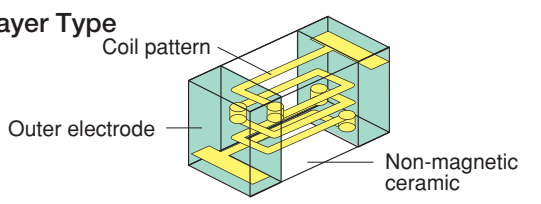
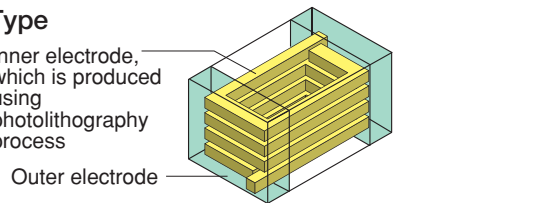
		Construction	Features
RF Inductors	Wire Wound Type For Radio Frequency 	Resin coating on the top Non-magnetic ceramic core Wire Electrode	High Q Large inductance
	Wire Wound Type For Intermediate Frequency 	Resin coating on the top Ferrite core for high frequency Wire Electrode	High Q at intermediate frequency
	Multilayer Type 	Coil pattern Outer electrode Non-magnetic ceramic	Industrial standard design
	Film Type 	Inner electrode, which is produced using photolithography process Outer electrode	Small size, but high Q

● Technical Data

1. Land Area and Q-F Characteristics

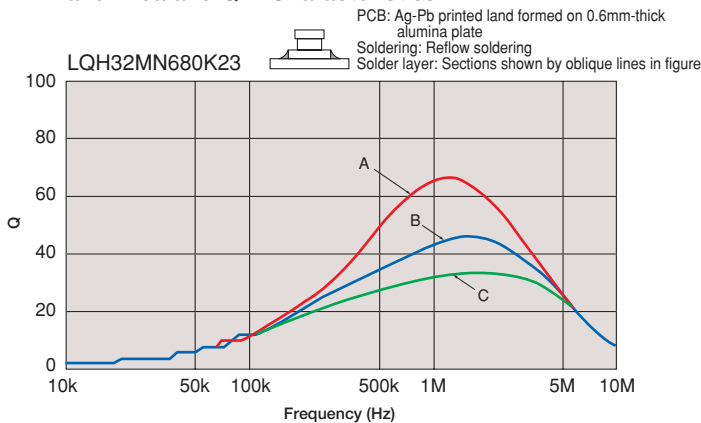

A : Net characteristics without land pattern

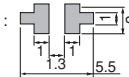
B :  Characteristic of chip mounted on land

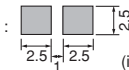
C :  Characteristic of chip mounted on land
 (in mm)

2. Coupling Coefficient Versus Distance between Parts

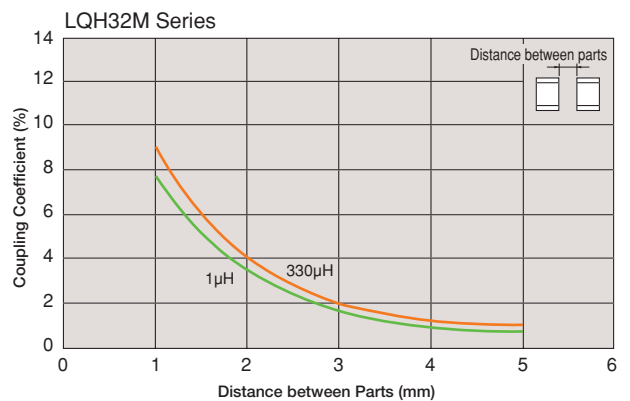

⚠Note • Please read rating and ⚠CAUTION (for storage, operating, rating, soldering, mounting and handling) in this catalog to prevent smoking and/or burning, etc.
 • This catalog has only typical specifications. Therefore, please approve our product specifications or transact the approval sheet for product specifications before ordering.

Murata's LQ□ series of chip inductors (chip coils) consists of compact, high-performance inductors. Their innovative coil and case structures mean low DC resistance and outstanding high-frequency characteristics. The series is designed for a variety of applications, facilitating component selection for individual circuit requirements.

	Part Number	Structure	Size Code in inch (in mm)	Inductance Range (H)									
				1n	10n	100n	1μ	10μ	100μ	1m	10m		
Inductors for Power Lines	LQW15CN_00 <small>p86</small>	Wire Wound Type (Ferrite Core)	0402 (1005)		18nH		200nH						
	LQW15CN_10 <small>p87</small>		0402 (1005)			220nH		560nH					
	LQW18CN_00 <small>p89</small>		0603 (1608)		4.9nH			650nH					
	LQH2MCN_02 <small>p42</small>		0806 (2016)					1.0μH		82μH			
	LQH2MCN_52 <small>p44</small>		0806 (2016)					1.0μH		22μH			
	LQH2HPN_G0 <small>p46</small>		1008 (2520)					2.2μH			100μH		
	LQH2HPN_GR <small>p48</small>		1008 (2520)					470nH		22μH			
	LQH2HPN_J0 <small>p50</small>		1008 (2520)					1.5μH		10μH			
	LQH2HPN_M0 <small>p52</small>		1008 (2520)					2.2μH		4.7μH			
	LQH3NPN_G0 <small>p59</small>		1212 (3030)					1.0μH			250μH		
	LQH3NPN_J0 <small>p57</small>		1212 (3030)					1.0μH		47μH			
	LQH3NPN_M0 <small>p53</small>		1212 (3030)					1.0μH		100μH			
	LQH3NPN_MR <small>p55</small>		1212 (3030)					1.0μH		47μH			
	LQH32PN_N0 <small>p61</small>		1210 (3225)					470nH		120μH			
	LQH32PN_NC <small>p63</small>		1210 (3225)					470nH		22μH			
	LQH32PB_N0 <small>p65</small>		1210 (3225)					470nH		120μH			
	LQH32PB_NC <small>p67</small>		1210 (3225)					470nH		22μH			
	LQH43PN_26 <small>p69</small>		1812 (4532)					1.0μH		220μH			
	LQH43PB_26 <small>p71</small>		1812 (4532)					1.0μH		220μH			
	LQH44PN_J0 <small>p75</small>		1515 (4040)					1.0μH		47μH			
	LQH44PN_P0 <small>p73</small>		1515 (4040)					1.0μH		22μH			
	LQH5BPN_T0 <small>p77</small>		2020 (5050)					470nH		22μH			
	LQH5BPN_T0 <small>p79</small>		2020 (5050)					470nH		22μH			
	LQH31CN_03 <small>p90</small>		1206 (3216)					120nH		100μH			
	LQH32CN_23/33 <small>p91</small>		1210 (3225)					150nH		560μH			
	LQH32CN_53 <small>p93</small>		1210 (3225)					1.0μH		100μH			
	LQH43CN_03 <small>p94</small>		1812 (4532)					1.0μH		470μH			
	LQH43CN_33 <small>p95</small>		1812 (4532)					560nH		3.9μH			
	LQH55DN_03 <small>p96</small>		2220 (5750)					120nH				10mH	
	LQH66SN_03 <small>p98</small>		2525 (6363)					270nH				10mH	
	LQM18PN_B0 <small>p16</small>		0603 (1608)						1.5μH				
	LQM18PN_C0 <small>p17</small>		0603 (1608)						470nH		2.2μH		
	LQM18PN_D0 <small>p18</small>		0603 (1608)						2.5μH				
	LQM18PN_F0 <small>p19</small>		0603 (1608)						1.0μH				
	LQM18PN_FR <small>p20</small>		0603 (1608)						220nH		4.7μH		
	LQM21PN_C0 <small>p22</small>		0805 (2012)						470nH		2.2μH		
	LQM21PN_G0 <small>p23</small>		0805 (2012)						470nH		3.3μH		
	LQM21PN_GS <small>p24</small>		0805 (2012)						2.2μH		4.7μH		
	LQM21PN_GC <small>p25</small>		0805 (2012)						1.0μH		2.2μH		
	LQM21PN_GR <small>p26</small>		0805 (2012)						1.0μH		4.7μH		
	LQM2MPN_G0 <small>p27</small>		0806 (2016)						470nH		4.7μH		
	LQM2MPN_GH <small>p29</small>		0806 (2016)					160nH		2.2μH			
	LQM2HPN_G0 <small>p34</small>		1008 (2520)						470nH		4.7μH		
	LQM2HPN_GS <small>p35</small>		1008 (2520)						2.2μH		4.7μH		
	LQM2HPN_GC <small>p36</small>		1008 (2520)						1.0μH		4.7μH		
LQM2HPN_GH <small>p37</small>	1008 (2520)						470nH		2.2μH				
LQM2HPN_J0 <small>p31</small>	1008 (2520)						1.0μH		3.3μH				
LQM2HPN_JC <small>p33</small>	1008 (2520)						1.0μH		2.2μH				
LQM2HPN_JH <small>p32</small>	1008 (2520)						470nH		2.2μH				
LQM2HPN_E0 <small>p38</small>	1008 (2520)							560nH					
LQM31PN_00 <small>p39</small>	1206 (3216)						470nH		4.7μH				
LQM31PN_C0 <small>p40</small>	1206 (3216)						470nH		2.2μH				
LQM32PN_G0 <small>p41</small>	1210 (3225)						1.0μH						
LQM18FN_00 <small>p81</small>	0603 (1608)						1.0μH		10μH				
LQM21DN_00 <small>p82</small>	0805 (2012)						1.0μH		47μH				
LQM21FN_00 <small>p83</small>	0805 (2012)						1.0μH		47μH				
LQM21FN_70 <small>p84</small>	0805 (2012)						4.7μH		10μH				
LQM21FN_80 <small>p85</small>	0805 (2012)						4.7μH		10μH				
Inductors for General Use	LQB15NN_10 <small>p119</small>	Multilayer Type (Ferrite Core)	0402 (1005)			220nH		560nH					
	LQB18NN_10 <small>p121</small>		0603 (1608)			220nH		560nH					
	LQM18NN_00 <small>p123</small>		0603 (1608)		47nH		2.2μH						
	LQM21NN_10 <small>p125</small>	Wire Wound Type (Ferrite Core)	0805 (2012)			100nH		4.7μH					
	LQH31MN_03 <small>p127</small>		1206 (3216)			150nH		100μH					
	LQH32MN_23 <small>p129</small>		1210 (3225)				1.0μH		560μH				
	LQH43M(N)N_03 <small>p131</small>		1812 (4532)				1.0μH		2.2mH				
LQH44NN_03 <small>p134</small>	1515 (4040)				510nH		470μH						

Inductance Lineup

- : E-24 or Higher
- : E-12
- : 0.1nH Step
- : Other



*There are some items that do not match to E step.

CAUTION: Use rosin-based flux, but not strong acidic flux (with chlorine content exceeding 0.2wt%) when soldering chip inductors (chip coils). Do not use water-soluble flux.

⚠Note • Please read rating and ⚠CAUTION (for storage, operating, rating, soldering, mounting and handling) in this catalog to prevent smoking and/or burning, etc.
• This catalog has only typical specifications. Therefore, please approve our product specifications or transact the approval sheet for product specifications before ordering.

	Part Number	Rated Current (A)				Thickness max.	Low Rdc	Bias	E-12 Step	E-24 Step	HiQ	Tight Tolerance	FlowOK	New
		10m	100m	1	10									
Inductors for Power Lines	LQW15CN_00	p86		390mA	1.4A	0.6mm								
	LQW15CN_10	p87		300mA	450mA	0.6mm							New	
	LQW18CN_00	p89		430mA	2.6A	0.95mm								
	LQH2MCN_02	p42		90mA	485mA	0.95mm								
	LQH2MCN_52	p44		130mA	595mA	0.7mm								
	LQH2HPN_G0	p46		130mA	1.0A	1.0mm								
	LQH2HPN_GR	p48		430mA	2.52A	1.0mm	Low Rdc						New	
	LQH2HPN_J0	p50		550mA	1.5A	1.2mm								
	LQH2HPN_M0	p52		800mA	1.25A	1.5mm								
	LQH3NPN_G0	p59		130mA	1.525A	1.0mm								
	LQH3NPN_J0	p57		350mA	1.62A	1.2mm								
	LQH3NPN_M0	p53		240mA	2.05A	1.5mm								
	LQH3NPN_MR	p55		460mA	2.15A	1.5mm	Low Rdc							
	LQH32PN_NO	p61		200mA	2.55A	1.7mm								
	LQH32PN_NC	p63		550mA	2.9A	1.7mm		Bias						
	LQH32PB_NO	p65		200mA	2.55A	1.7mm								
	LQH32PB_NC	p67		550mA	2.9A	1.7mm		Bias						
	LQH43PN_26	p69		240mA	3.3A	2.8mm							Flow	
	LQH43PB_26	p71		240mA	3.3A	2.8mm							New	
	LQH44PN_J0	p75		380mA	1.53A	1.2mm								
	LQH44PN_P0	p73		790mA	2.45A	1.8mm								
	LQH5BPN_T0	p77		1.05A	4.0A	2.2mm								
	LQH5BPB_T0	p79		1.05A	4.0A	2.2mm							New	
	LQH31CN_03	p90		80mA	970mA	2.0mm							Flow	
	LQH32CN_23/33	p91		60mA	1.45A	2.2mm							Flow	
	LQH32CN_53	p93		100mA	1.0A	1.7mm							Flow	
	LQH43CN_03	p94		90mA	1.08A	2.8mm							Flow	
	LQH43CN_33	p95			1.6A	2.95A	2.8mm						Flow	
	LQH55DN_03	p96		50mA	6.0A	5.0mm								
	LQH66SN_03	p98		50mA	6.0A	5.0mm								
	LQM18PN_B0	p16		600mA		0.4mm							Flow	
	LQM18PN_C0	p17		700mA	850mA	0.55mm							Flow New	
	LQM18PN_D0	p18		700mA		0.75mm							Flow	
	LQM18PN_F0	p19		600mA		0.95mm							Flow	
	LQM18PN_FR	p20		620mA	1.25A	0.95mm	Low Rdc						Flow	
	LQM21PN_C0	p22		600mA	1.1A	0.55mm							Flow	
	LQM21PN_G0	p23		800mA	1.3A	1.0mm							Flow	
	LQM21PN_GS	p24		750mA	950mA	1.0mm							Flow	
	LQM21PN_GC	p25		800mA	900mA	1.0mm		Bias					Flow	
	LQM21PN_GR	p26		800mA	1.3A	1.0mm	Low Rdc						Flow	
	LQM2MPN_G0	p27		1.1A	1.6A	1.0mm							Flow	
	LQM2MPN_GH	p29		1.0A	4.0A	1.0mm	Low Rdc	Bias					New	
	LQM2HPN_G0	p34		1.1A	1.8A	1.0mm							Flow	
	LQM2HPN_GS	p35		1.0A	1.1A	1.0mm							Flow	
	LQM2HPN_GC	p36		800mA	1.5A	1.0mm		Bias					Flow	
	LQM2HPN_GH	p37		1.5A	2.6A	1.0mm	Low Rdc	Bias					New	
	LQM2HPN_J0	p31		1.0A	1.5A	1.2mm							Flow	
	LQM2HPN_JC	p33		1.0A	1.5A	1.2mm		Bias					Flow	
LQM2HPN_JH	p32		1.5A	2.7A	1.2mm	Low Rdc	Bias					New		
LQM2HPN_E0	p38			1.5A	0.8mm							Flow		
LQM31PN_O0	p39		700mA	1.4A	0.95mm							Flow		
LQM31PN_C0	p40		900mA	1.3A	0.55mm							Flow		
LQM32PN_G0	p41			1.8A	1.0mm									
LQM18FN_00	p81		50mA	150mA	0.9mm							Flow		
LQM21DN_00	p82	7.0mA	60mA		1.45mm							Flow		
LQM21FN_00	p83	7.0mA	220mA		1.45mm							Flow		
LQM21FN_70	p84		100mA	120mA	1.45mm							Flow		
LQM21FN_80	p85		100mA	120mA	1.45mm							Flow		
Inductors for General Use	LQB15NN_10	p119		300mA	380mA	0.55mm			E-12				New	
	LQB18NN_10	p121		300mA	450mA	0.95mm			E-12				Flow New	
	LQM18NN_00	p123	15mA	50mA		0.95mm			E-12				Flow	
	LQM21NN_10	p125	30mA	250mA		1.45mm			E-12				Flow	
	LQH31MN_03	p127		45mA	250mA	2.0mm			E-12				Flow	
	LQH32MN_23	p129		40mA	445mA	2.2mm			E-12				Flow	
	LQH43M(N)N_03	p131		30mA	500mA	2.8mm			E-12				Flow	
	LQH44NN_03	p134		145mA	4.5A	4.5mm							New	

Continued on the following page. 

 Note • Please read rating and  CAUTION (for storage, operating, rating, soldering, mounting and handling) in this catalog to prevent smoking and/or burning, etc.
• This catalog has only typical specifications. Therefore, please approve our product specifications or transact the approval sheet for product specifications before ordering.



	Part Number	Structure	Size Code in inch (in mm)	Inductance Range (H)									
				1n	10n	100n	1μ	10μ	100μ	1m	10m		
RF Inductors	LQG15HN_02 <small>p148</small>	Multilayer Type (Non-Magnetic Core)	0402 (1005)	1.0nH	120nH								
	LQG15HS_02 <small>p150</small>		0402 (1005)	1.0nH	270nH								
	LQG18HN_00 <small>p153</small>		0603 (1608)	1.2nH	100nH								
	LQP02TN_02 <small>p155</small>	Film Type (Non-Magnetic Core)	01005 (0402)	0.2nH	39nH								
	LQP02TQ_02 <small>p161</small>		01005 (0402)	0.4nH	10nH								
	LQP03TG_02 <small>p164</small>		0201 (0603)	0.6nH	120nH								
	LQP03TN_02 <small>p169</small>		0201 (0603)	0.6nH	270nH								
	LQP15MN_02 <small>p174</small>		0402 (1005)	1.0nH	33nH								
	LQP18MN_02 <small>p177</small>		0603 (1608)	1.3nH	100nH								
	LQW03AW_00 <small>p179</small>	Wire Wound Type (Non-Magnetic Core)	-		5.4nH	13nH							
	LQW04AN_00 <small>p181</small>		03015 (0804)	1.1nH	33nH								
	LQW15AN_00 <small>p184</small>		0402 (1005)	1.5nH	120nH								
	LQW15AN_10 <small>p189</small>		0402 (1005)	1.3nH	5.6nH								
	LQW15AN_80 <small>p191</small>		0402 (1005)	1.3nH	75nH								
	LQW18AN_00 <small>p199</small>		0603 (1608)	2.2nH	470nH								
	LQW18AN_10 <small>p203</small>		0603 (1608)	2.2nH	33nH								
	LQW18AN_80 <small>p205</small>		0603 (1608)	2.2nH	390nH								
	LQW2BAS_00 <small>p213</small>		0805 (2015)	2.8nH	820nH								
	LQW2BHN_03 <small>p209</small>		0805 (2015)	3.3nH	470nH								
	LQW2BHN_13 <small>p211</small>		0805 (2015)	2.7nH	27nH								
	LQW2UAS_00 <small>p216</small>		1008 (2520)		12nH	4.7μH							
	LQW31HN_03 <small>p219</small>		1206 (3216)		8.8nH	100nH							
	LQW21HN_00 <small>p221</small>		Wire Wound Type (Ferrite Core)	0805 (2012)		470nH	2.2μH						
	LQH31HN_03 <small>p223</small>			1206 (3216)		54nH	880nH						

Inductance Lineup

- : E-24 or Higher
- : E-12
- : 0.1nH Step
- : Other

*There are some items that do not match to E step.

CAUTION: Use rosin-based flux, but not strong acidic flux (with chlorine content exceeding 0.2wt%) when soldering chip inductors (chip coils). Do not use water-soluble flux.

Note • Please read rating and CAUTION (for storage, operating, rating, soldering, mounting and handling) in this catalog to prevent smoking and/or burning, etc.
 • This catalog has only typical specifications. Therefore, please approve our product specifications or transact the approval sheet for product specifications before ordering.

	Part Number	Rated Current (A)				Thickness max.	Low Rdc	Bias	E-12 Step	E-24 Step	Hi Q	Tight Tolerance	Flow OK	New
		10m	100m	1	10									
RF Inductors	LQG15HN_02 p148		150mA	300mA		0.55mm			E-12	E-24				
	LQG15HS_02 p150		110mA	300mA		0.55mm			E-12	E-24				
	LQG18HN_00 p153			300mA	500mA	0.95mm			E-12					
	LQP02TN_02 p155		90mA	320mA		0.22mm				E-24		Tight	New	
	LQP02TQ_02 p161		170mA	990mA		0.22mm			E-12	E-24	High Q	Tight	New	
	LQP03TG_02 p164		80mA	850mA		0.33mm			E-12	E-24		Tight	New	
	LQP03TN_02 p169		60mA	850mA		0.33mm				E-24		Tight	New	
	LQP15MN_02 p174		60mA	400mA		0.45mm			E-12	E-24		Tight		
	LQP18MN_02 p177		50mA	300mA		0.6mm			E-12	E-24		Tight		
	LQW03AW_00 p179			280mA	460mA	0.45mm			E-12	E-24			New	
	LQW04AN_00 p181		140mA	990mA		0.45mm			E-12	E-24				
	LQW15AN_00 p184		110mA	1.0A		0.6mm			E-12	E-24		Tight		
	LQW15AN_10 p189			800mA	1.2A	0.6mm	Low Rdc		E-12	E-24	High Q	Tight		
	LQW15AN_80 p191			320mA	3.15A	0.6mm	Low Rdc		E-12	E-24	High Q	Tight	New	
	LQW18AN_00 p199		75mA	850mA		1.0mm			E-12	E-24		Tight		
	LQW18AN_10 p203			550mA	1.4A	1.0mm	Low Rdc		E-12		High Q	Tight		
	LQW18AN_80 p205		190mA	3.2A		1.0mm	Low Rdc		E-12	E-24		Tight	New	
	LQW2BAS_00 p213		180mA	800mA		1.52mm			E-12	E-24				
	LQW2BHN_03 p209		160mA	1.32A		1.78mm			E-12			Tight	Flow	
	LQW2BHN_13 p211			900mA	1.9A	1.78mm			E-12		High Q		Flow	
	LQW2UAS_00 p216		260mA	1.0A		2.03mm			E-12	E-24				
	LQW31HN_03 p219		230mA	750mA		2.0mm			E-12				Flow	
	LQW21HN_00 p221		75mA	160mA		1.0mm			E-12					
LQH31HN_03 p223		180mA	920mA		2.0mm							Flow		

Note • Please read rating and CAUTION (for storage, operating, rating, soldering, mounting and handling) in this catalog to prevent smoking and/or burning, etc.
 • This catalog has only typical specifications. Therefore, please approve our product specifications or transact the approval sheet for product specifications before ordering.

Construction?

Circuit Type?	Construction?		
	Wire Wound	Multilayer	Film
Power Line	LQW15CN/0402(1005) p86 18–560nH/300–1400mA	LQM18PN/0603(1608) p16 0.22–4.7μH/600–1250mA	
	LQW18CN/0603(1608) p89 4.9–650nH/430–2600mA	LQM21PN/0805(2012) p22 0.47–4.7μH/600–1300mA(*1)	
	LQH2MCN/0806(2016) p42 1.0–82μH/90–595mA	LQM2MPN/0806(2016) p27 0.16–4.7μH/1100–4000mA	
	LQH2HPN/1008(2520) p46 0.47–100μH/130–2520mA	LQM2HPN/1008(2520) p34 0.47–4.7μH/800–2700mA	
	LQH3NPN/1212(3030) p59 1.0–250μH/130–2150mA	LQM31PN/1206(3216) p39 0.47–4.7μH/700–1400mA	
	LQH32PN/1210(3225) p61 0.47–120μH/200–2900mA	LQM32PN/1210(3225) p41 1.0μH/1800mA	
	LQH32PB/1210(3225) p65 0.47–120μH/200–2900mA	LQM18FN/0603(1608) p81 1.0–10μH/50–150mA	
	LQH43PN/1812(4532) p69 1.0–220μH/240–3300mA	LQM21DN/0805(2012) p82 1.0–47μH/7–60mA	
	LQH43PB/1812(4532) p71 1.0–220μH/240–3300mA	LQM21FN/0805(2012) p83 1.0–47μH/7–220mA	
	LQH44PN/1515(4040) p75 1.0–47μH/380–2450mA		
	LQH5BPN/2020(5050) p77 0.47–22μH/1.05–4.0A		
	LQH5BPB/2020(5050) p79 0.47–22μH/1.05–4.0A		
	LQH31CN/1206(3216) p90 0.12–100μH/80–970mA		
	LQH32CN/1210(3225) p91 0.15–560μH/60–1450mA		
	LQH43CN/1812(4532) p94 0.56–470μH/90–2950mA		
LQH55DN/2220(5750) p96 0.12–10000μH/0.05–6.0A			
LQH66SN/2525(6363) p98 0.27–10000μH/0.05–6.0A			
Less than 100MHz General Use	LQH31MN/1206(3216) p127 0.15–100μH/45–250mA	LQB15NN/0402(1005) p119 220–560nH/300–380mA	
	LQH32MN/1210(3225) p129 1.0–560μH/40–445mA	LQB18NN/0603(1608) p121 220–560nH/300–450mA	
	LQH43M(N)N/1812(4532) p131 1.0–2200μH/30–500mA	LQM18NN/0603(1608) p123 47–2200nH/15–50mA	
	LQH44NN/1515(4040) p134 0.51–470μH/0.145–4.5A	LQM21NN/0805(2012) p125 0.1–4.7μH/30–250mA	
Signal Line High Frequency	LQW03AW/- p179 5.4–13nH/280–460mA	LQG15HN/0402(1005) p148 1.0–120nH/150–300mA	LQP02TN/01005(0402) p155 0.2–39nH/90–320mA
	LQW04AN/03015(0804) p181 1.1–33nH/140–990mA	LQG15HS/0402(1005) p150 1.0–270nH/110–300mA	LQP02TQ/01005(0402) p161 0.4–10nH/170–990mA
	LQW15AN/0402(1005) p184 1.3–120nH/110–3150mA	LQG18HN/0603(1608) p153 1.2–100nH/300–500mA	LQP03TG/0201(0603) p164 0.6–120nH/80–850mA
	LQW18AN/0603(1608) p199 2.2–470nH/75–3200mA		LQP03TN/0201(0603) p169 0.6–270nH/60–850mA
	LQW2BHN/0805(2015) p209 2.7–470nH/160–1900mA		LQP15MN/0402(1005) p174 1.0–33nH/60–400mA
	LQW2BAS/0805(2015) p213 2.8–820nH/180–800mA		LQP18MN/0603(1608) p179 1.3–100nH/50–300mA
	LQW2UAS/1008(2520) p216 12–4700nH/260–1000mA		
	LQW31HN/1206(3216) p219 8.8–100nH/230–750mA		
	LQW21HN/0805(2012) p221 0.47–2.2μH/75–160mA		
	LQH31HN/1206(3216) p223 54–880nH/180–920mA		

Guide for Digits in this Chart:

● for LQW15CN 0402 (1005)/18–560nH/300–1400mA

Size (inch) Size (mm) Inductance Rated Current

*1 In operating temperature exceeding +85°C, derating of current is necessary for LQM21PN3R3NG0/LQM21PN3R3MG0-LQW15C series. Please apply the derating curve shown in detailed page according to the operating temperature.

⚠Note • Please read rating and ⚠CAUTION (for storage, operating, rating, soldering, mounting and handling) in this catalog to prevent smoking and/or burning, etc. • This catalog has only typical specifications. Therefore, please approve our product specifications or transact the approval sheet for product specifications before ordering.



Which Thickness?

Inductors for Power Lines

	Multilayer Type	Wire Wound Type	Multilayer Type for Choke	Wire Wound Type for Choke
0.35mm	LQM18P_B0			
0.5mm	LQM18P_C0 / LQM21P_C0 / LQM31P_C0			LQW15C
0.6mm	LQM18P_D0			
0.65mm		LQH2MC_52		
0.7mm	LQM2HP_E0			
0.8mm	LQM18P_F0 / FR		LQM18F	LQW18C
0.85mm	LQM31P_00		LQM21D (1.0 to 10μH) / LQM21F_00 (1.0 to 2.2μH)	
0.9mm	LQM21P_G0 / GS / GC / GR / LQM2MP_G0 / GH / LQM2HP_G0 / GS / GC / GH / LQM32P_G0	LQH2MC_02 / LQH2HP_G0 / GR / LQH3NP_G0		
1.1mm	LQM2HP_J0 / JH	LQH2HP_J0 / LQH3NP_J0 / LQH44P_J0		
1.25mm			LQM21D (22 to 47μH) / LQM21F_00 (4.7 to 47μH) / LQM21F_70 / 80	
1.4mm		LQH2HP_M0 LQH3NP_M0 / MR		
1.55mm		LQH32P_N0 / NC		LQH32C_53
1.65mm		LQH44P_P0		
1.8mm				LQH31C
2.0mm		LQH5BP_T0		LQH32C_23 / 33
2.6mm		LQH43P_26		LQH43C_03 / 33
4.7mm				LQH55D / LQH66S

Which Thickness?

Inductors for General Use

RF Inductors

	Multilayer Type	Wire Wound Type	Multilayer Type	Film Type	Wire Wound Type
0.2mm				LQP02T	
0.3mm				LQP03T	
0.35mm				LQP15M	
0.4mm				LQP15T	LQW03AW / LQW04A
0.5mm	LQB15N		LQG15HN / LQG15HS	LQP18M	LQW15A
0.8mm	LQB18N / LQM18N		LQG18H		LQW18A
0.85mm	LQM21N (0.1 to 2.2μH)				
0.9mm					LQW21H
1.25mm	LQM21N (2.7 to 4.7μH)				
1.42mm					LQW2BA
1.7mm					LQW2BH
1.8mm		LQH31M			LQH31H / LQW31H
1.83mm					LQW2UA
2.0mm		LQH32M			
2.6mm		LQH43M(N)			
4.3mm		LQH44N			

⚠Note • Please read rating and ⚠CAUTION (for storage, operating, rating, soldering, mounting and handling) in this catalog to prevent smoking and/or burning, etc.
• This catalog has only typical specifications. Therefore, please approve our product specifications or transact the approval sheet for product specifications before ordering.



Memo

● Inductors for Power Lines

Introduction	12
Part Numbering	14
Product Detail	16
⚠Caution/Notice	100
Soldering and Mounting	102
Packaging	107
Design Kits	111

⚠Note • Please read rating and ⚠CAUTION (for storage, operating, rating, soldering, mounting and handling) in this catalog to prevent smoking and/or burning, etc.
• This catalog has only typical specifications. Therefore, please approve our product specifications or transact the approval sheet for product specifications before ordering.

Introduction of Power Inductors

Effect of losses in power Inductors to voltage conversion efficiency

Important factor of power Inductors changes according to working condition of power supply.

● Effect of Magnetic Loss

Magnetic loss affect to efficiency at low output condition.

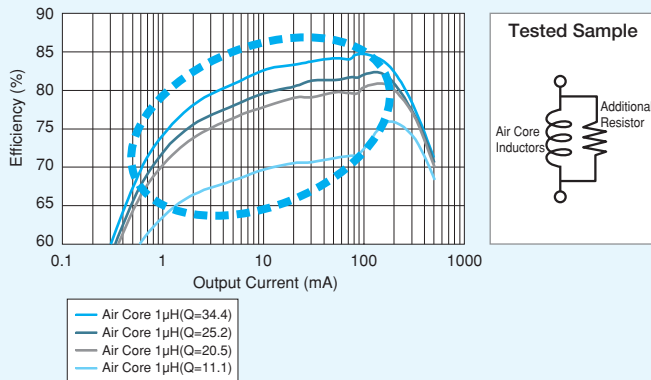

● Effect of DC Resistance

DC resistance affect to efficiency at high output condition.

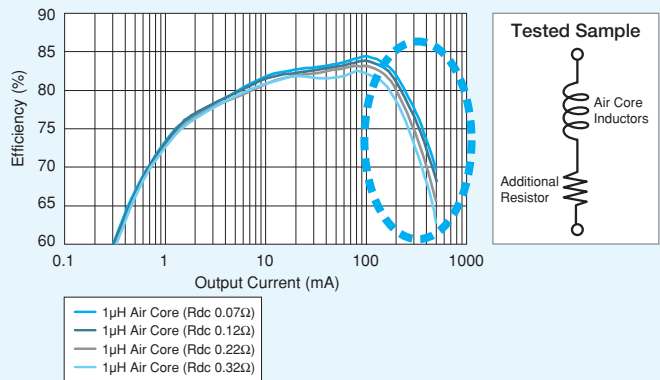

We design inductors to match the application using the latest simulation technology.



● Power Inductors Wire Wound Type Lineup (Core Product)

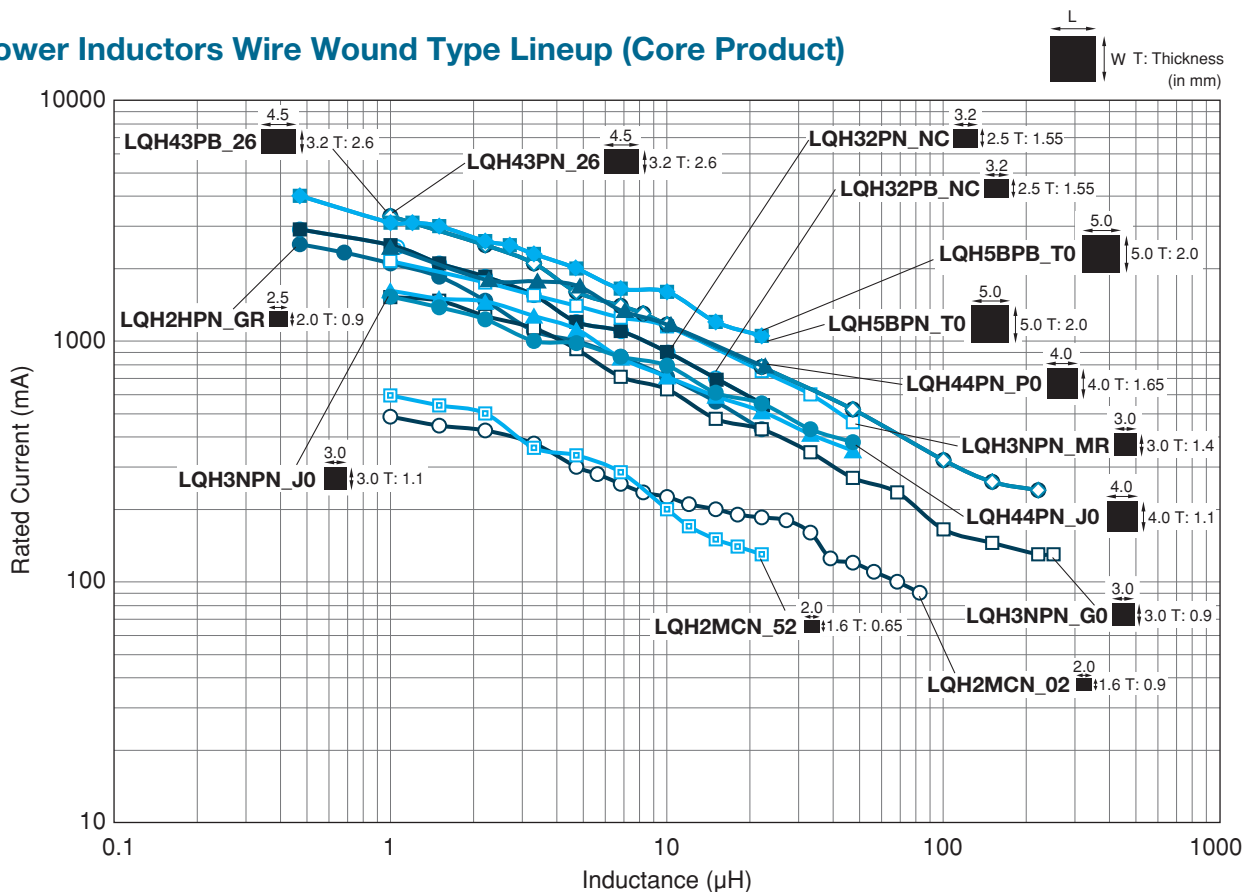

Δ Note • Please read rating and Δ CAUTION (for storage, operating, rating, soldering, mounting and handling) in this catalog to prevent smoking and/or burning, etc.
• This catalog has only typical specifications. Therefore, please approve our product specifications or transact the approval sheet for product specifications before ordering.

● Power Inductors Multilayer Type Size Code: 2012 max. (Core Product)

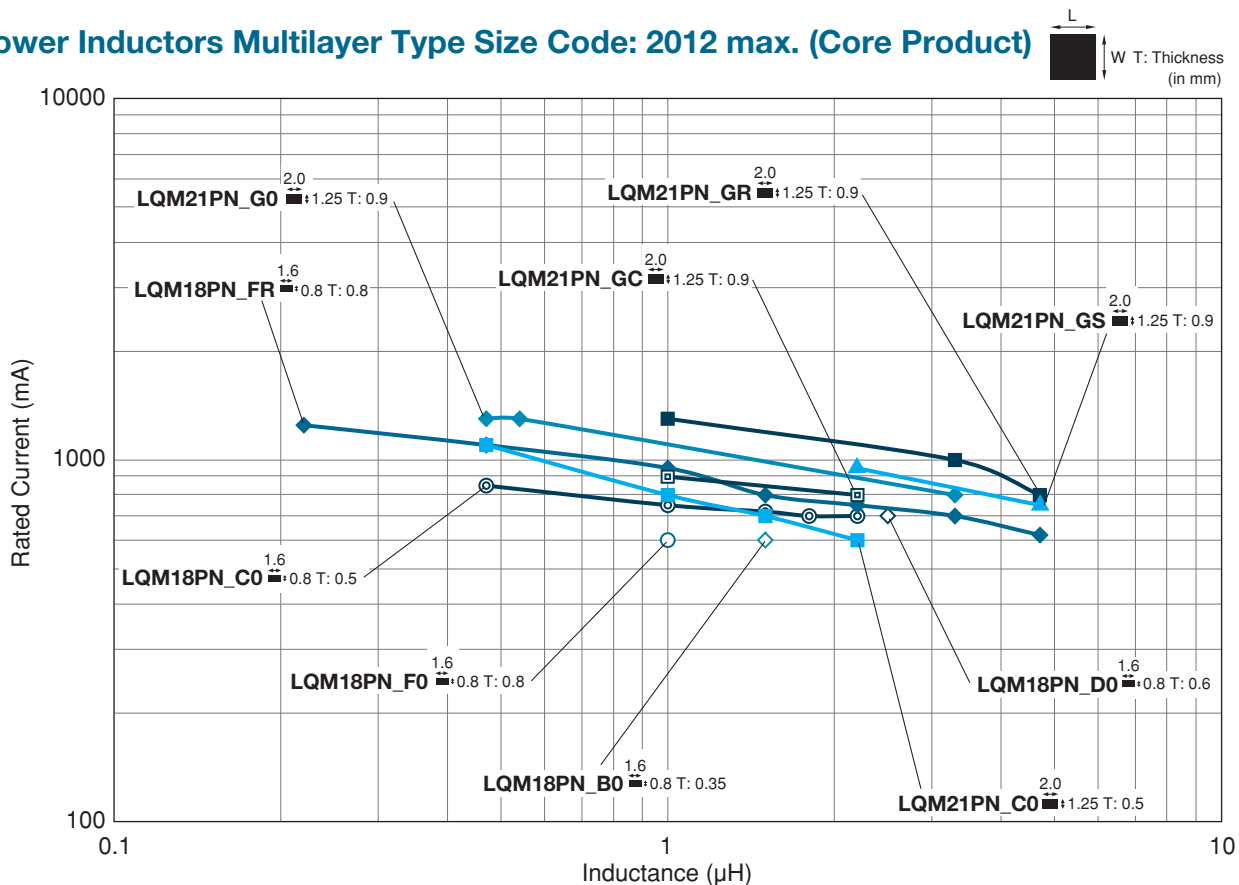

● Power Inductors Multilayer Type Size Code: 2016 min. (Core Product)

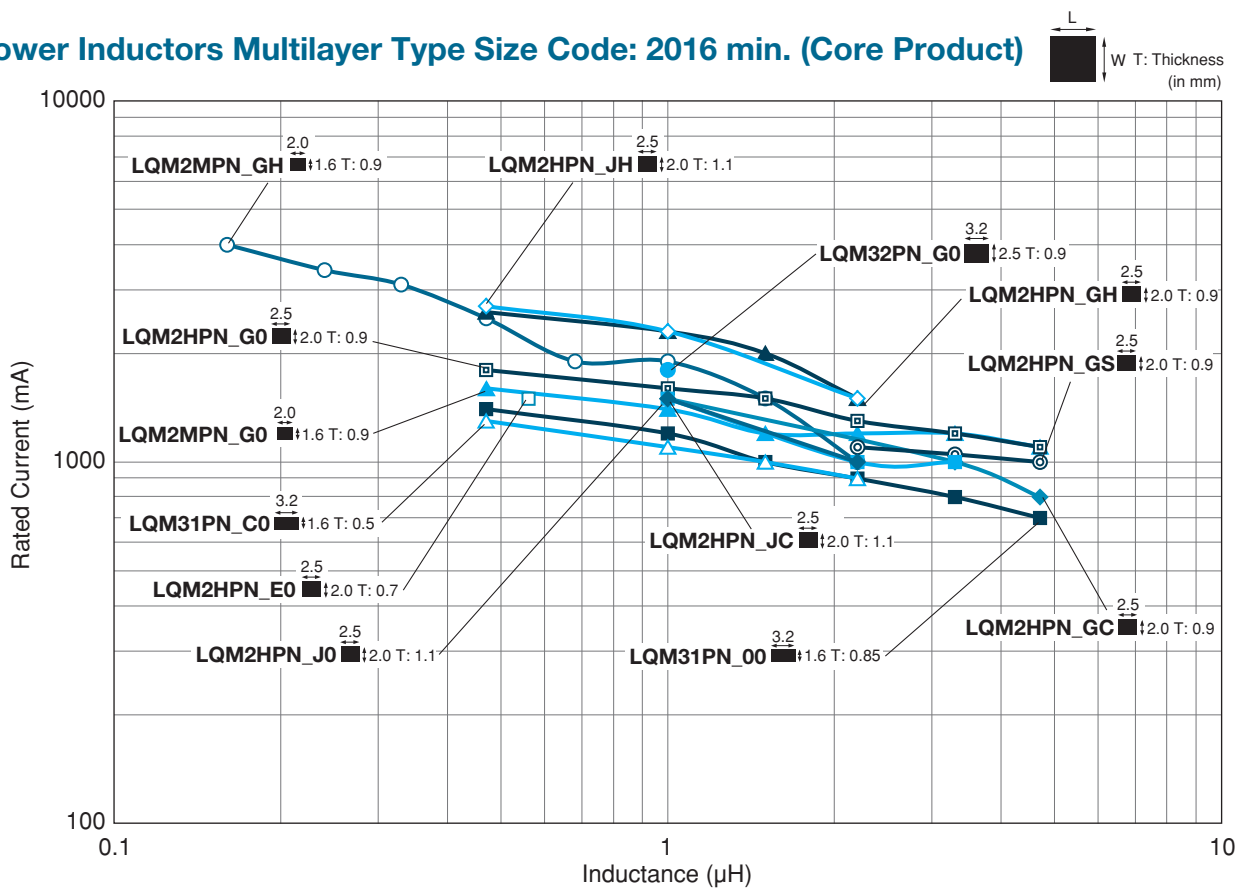

△Note • Please read rating and △CAUTION (for storage, operating, rating, soldering, mounting and handling) in this catalog to prevent smoking and/or burning, etc.
 • This catalog has only typical specifications. Therefore, please approve our product specifications or transact the approval sheet for product specifications before ordering.

Inductors for Power Lines Part Numbering

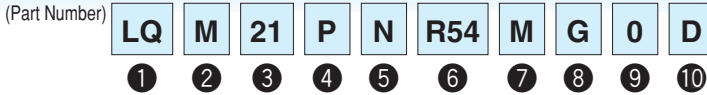

① Product ID

Product ID	
LQ	Chip Inductors (Chip Coils)

② Structure

Code	Structure
H	Wire Wound Type (Ferrite Core)
W	
M	Multilayer Type (Ferrite Core)

③ Dimensions (L×W)

Code	Dimensions (L×W)	Size Code (in inch)
15	1.0×0.5mm	0402
18	1.6×0.8mm	0603
21	2.0×1.25mm	0805
2M	2.0×1.6mm	0806
2H	2.5×2.0mm	1008
3N	3.0×3.0mm	1212
31	3.2×1.6mm	1206
32	3.2×2.5mm	1210
43	4.5×3.2mm	1812
44	4.0×4.0mm	1515
5B	5.0×5.0mm	2020
55	5.7×5.0mm	2220
66	6.3×6.3mm	2525

④ Applications and Characteristics

Code	Series	Applications and Characteristics
D	LQM	for Choke (Low-current DC Power Supplies)
F		for Choke (DC Power Supplies)
D	LQH	for Choke
S		for Choke (Magnetically Shielded Type)
C	LQH/LQW	for Choke (Coating Type)
P	LQM/LQH	for Power Line

⑤ Category

Code	Category
N	Standard Type
B	Special Feature Classification

⑥ Inductance

Expressed by three-digit alphanumerics. The unit is micro-henry (μH). The first and second figures are significant digits, and the third figure expresses the number of zeros that follow the two figures. If there is a decimal point, it is expressed by the capital letter "R." In this case, all figures are significant digits. If inductance is less than 0.1μH, the inductance code is expressed by a combination of two figures and the capital letter "N," and the unit of inductance is nano-henry (nH). The capital letter "N" indicates the unit of "nH," and also expresses a decimal point. In this case, all figures are significant digits.

⑦ Inductance Tolerance

Code	Inductance Tolerance
D	±0.5nH
J	±5%
K	±10%
M	±20%
N	±30%

⑧ Features (Except for LQH□□P/LQM□□P)

Code	Features	Series
0	Standard Type	LQM/LQH*1 /LQW
1	Low DC Resistance	LQW
2	Standard Type	LQH32C
3	Low DC Resistance	LQH32C/43CN
5	Low Profile Type	LQH2MC/32C
7	Large Current Type	LQM21F
8	Low DC Resistance /Large Current Type	

*1 Except for LQH32 Series

⑨ Thickness (LQH□□P/LQM□□P Only • Except for LQH43P)

Code	Dimensions (T)
B	0.35mm
C	0.5mm
D	0.6mm
E	0.7mm
F	0.8mm
0	0.85mm
G	0.9mm
J	1.1mm
M	1.4mm
N	1.55mm
P	1.65mm
T	2.0mm

⑩ Electrode (Except for LQH□□P/LQM□□P)

•Lead (Pb) Free

Code	Electrode	Series
0	Sn	LQM/LQW
2		LQH2MC
3	LF Solder	LQH (Except for LQH2MC)

⑪ Specification (LQH□□P/LQM□□P Only • Except for LQH43P)

Code	Specification
0/S	Standard Type
C	Good Bias Current Characteristics Type
H	High Spec Type (Low DC Resistance/ Good Bias Current Characteristics Type)
R	Low DC Resistance Type

Continued on the following page. 

△Note • Please read rating and △CAUTION (for storage, operating, rating, soldering, mounting and handling) in this catalog to prevent smoking and/or burning, etc.
• This catalog has only typical specifications. Therefore, please approve our product specifications or transact the approval sheet for product specifications before ordering.

⑧⑨ Thickness (LQH43P Only)

Code	Dimensions (T)
26	2.6mm

⑩ Packaging

Code	Packaging	Series
K	Embossed Taping (ø330mm Reel)	LQH*1 /LQM21*2
F		LQH3NP_MR
L	Embossed Taping (ø180mm Reel)	LQH*5/LQM18P/LQM21*2 /LQM31P/LQM2HP/LQM2MP
E		LQH3NP_MR
B	Bulk	LQH2MC/LQM/LQW
J	Paper Taping (ø330mm Reel)	LQM18/LQM21*3
D	Paper Taping (ø180mm Reel)	LQM18/LQM21*4 /LQW

*1 Except for LQH2MC/LQH2HP_G0/LQH3NP/LQH43C

*2 LQM21D(22 - 47μH)/LQM21F(4.7 - 47μH)

*3 LQM21D(1.0 - 10μH)/LQM21F(1.0 - 2.2μH)

*4 LQM21D(1.0 - 10μH)/LQM21F(1.0 - 2.2μH)/LQM21P

*5 Except for LQH3NP_MR

LQM18PN_B0 Series 0603/1608 (inch/mm)

Size Code 0603 (1608) in inch (in mm), 0.4mm max. Thickness

■ Appearance/Dimensions

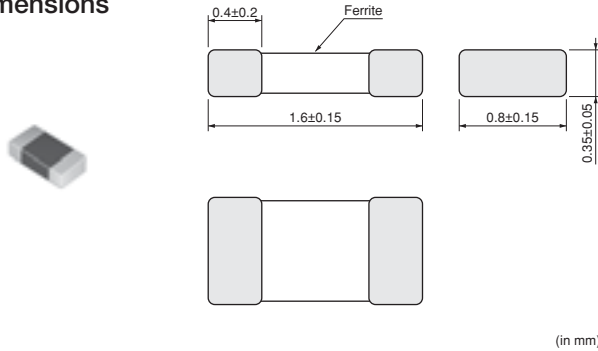

■ Packaging

Code	Packaging	Minimum Quantity
L	ø180mm Embossed Taping	4000
B	Packing in Bulk	1000



Refer to pages 102 to 106 for mounting information.

■ Rated Value (□: packaging code)

Part Number	Inductance	Inductance Test Frequency	Rated Current	DC Resistance	Self-Resonance Frequency (min.)	
LQM18PN1R5NB0□	1.5µH ±30%	1MHz	600mA	0.35Ω ±25%	50MHz	Kit

Class of Magnetic Shield: Magnetic shield of ferrite Operating Temperature Range: -55°C~+125°C

■ Inductance-Frequency Characteristics (Typ.)

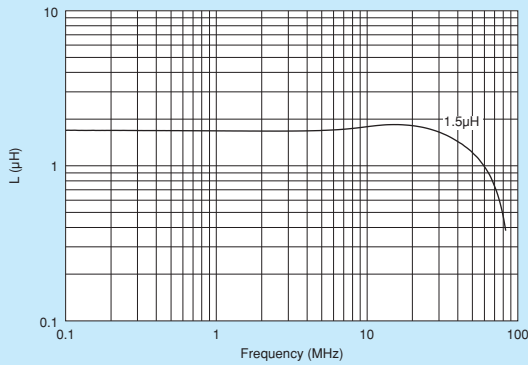

■ Inductance-Current Characteristics (Typ.)

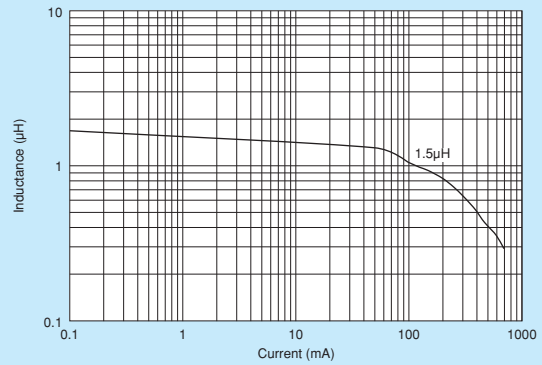

■ Temperature Rise Characteristics (Typ.)

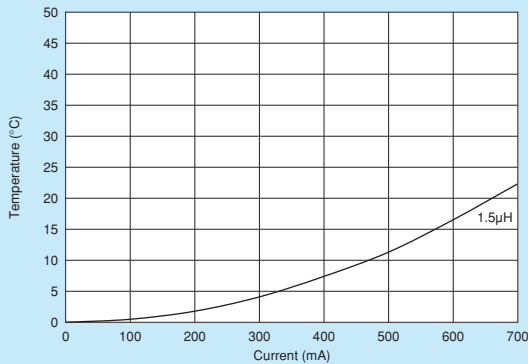

△Note • Please read rating and △CAUTION (for storage, operating, rating, soldering, mounting and handling) in this catalog to prevent smoking and/or burning, etc.
• This catalog has only typical specifications. Therefore, please approve our product specifications or transact the approval sheet for product specifications before ordering.

LQM18PN_C0 Series 0603/1608 (inch/mm)

Size Code 0603 (1608) in inch (in mm), 0.55mm max. Thickness

■ Appearance/Dimensions

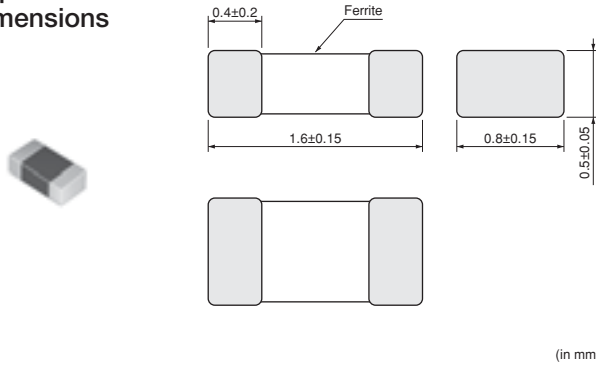

■ Packaging

Code	Packaging	Minimum Quantity
L	ø180mm Embossed Taping	4000
B	Packing in Bulk	1000



Refer to pages 102 to 106 for mounting information.

■ Rated Value (□: packaging code)

Part Number	Inductance	Inductance Test Frequency	Rated Current	DC Resistance	Self-Resonance Frequency (min.)	
LQM18PNR47NC0□	0.47μH ±30%	1MHz	850mA	0.15 Ω ±25%	50MHz	New
LQM18PN1R0NC0□	1.0μH ±30%	1MHz	750mA	0.20 Ω ±25%	50MHz	New
LQM18PN1R5NC0□	1.5μH ±30%	1MHz	720mA	0.22 Ω ±25%	50MHz	New
LQM18PN1R8NC0□	1.8μH ±30%	1MHz	700mA	0.24 Ω ±25%	50MHz	Kit
LQM18PN2R2NC0□	2.2μH ±30%	1MHz	700mA	0.24 Ω ±25%	50MHz	New

Class of Magnetic Shield: Magnetic shield of ferrite Operating Temperature Range: -55°C~+125°C

■ Inductance-Frequency Characteristics (Typ.)

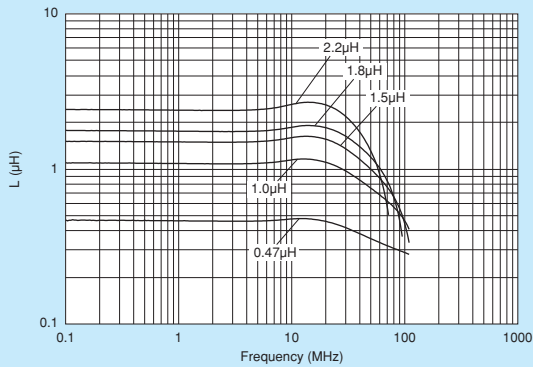

■ Inductance-Current Characteristics (Typ.)

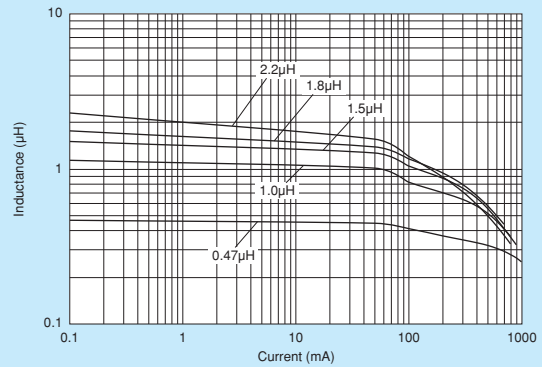

■ Temperature Rise Characteristics (Typ.)

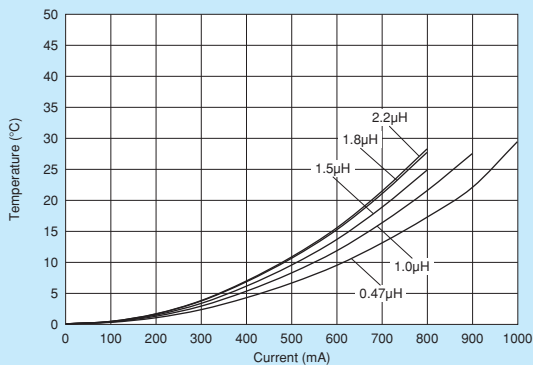

△Note • Please read rating and △CAUTION (for storage, operating, rating, soldering, mounting and handling) in this catalog to prevent smoking and/or burning, etc.
• This catalog has only typical specifications. Therefore, please approve our product specifications or transact the approval sheet for product specifications before ordering.

LQM18PN_D0

Series 0603/1608 (inch/mm)

Size Code 0603 (1608) in inch (in mm), 0.75mm max. Thickness

■ Appearance/Dimensions

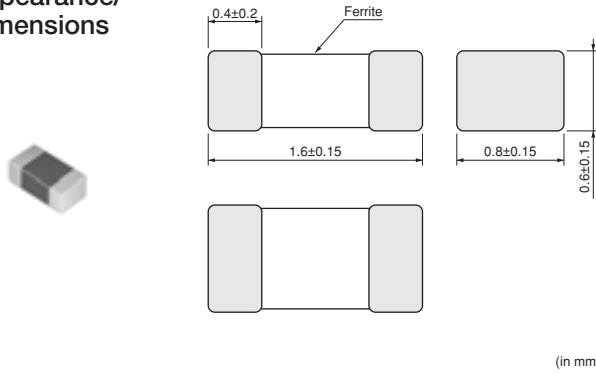

■ Packaging

Code	Packaging	Minimum Quantity
D	ø180mm Paper Taping	4000
B	Packing in Bulk	1000



Refer to pages 102 to 106 for mounting information.

■ Rated Value (□: packaging code)

Part Number	Inductance	Inductance Test Frequency	Rated Current	DC Resistance	Self-Resonance Frequency (min.)	
LQM18PN2R5ND0□	2.5μH ±30%	1MHz	700mA	0.24Ω ±25%	60MHz	Kit

Class of Magnetic Shield: Magnetic shield of ferrite Operating Temperature Range: -40°C~+85°C

■ Inductance-Frequency Characteristics (Typ.)

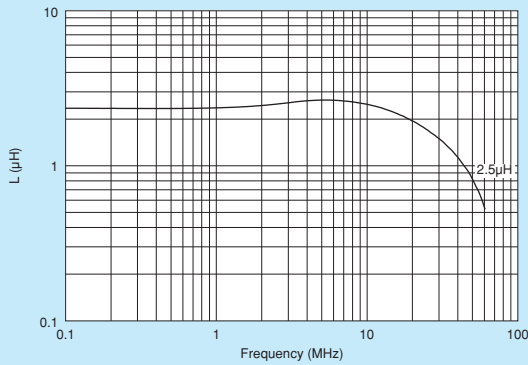

■ Inductance-Current Characteristics (Typ.)

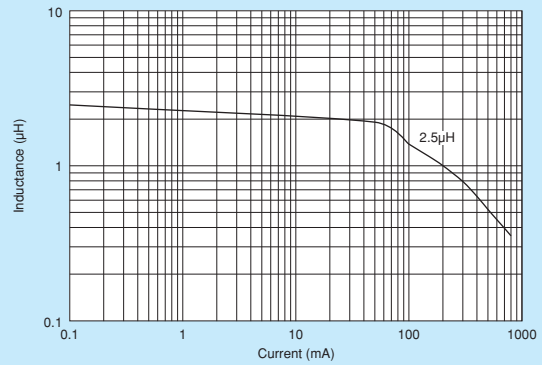

■ Temperature Rise Characteristics (Typ.)

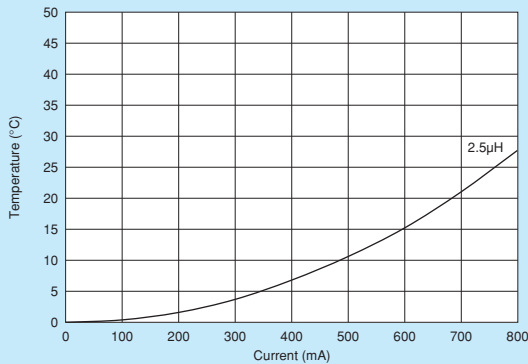

△Note • Please read rating and △CAUTION (for storage, operating, rating, soldering, mounting and handling) in this catalog to prevent smoking and/or burning, etc.
• This catalog has only typical specifications. Therefore, please approve our product specifications or transact the approval sheet for product specifications before ordering.

LQM18PN_F0 Series 0603/1608 (inch/mm)

Size Code 0603 (1608) in inch (in mm), 0.95mm max. Thickness

■ Appearance/Dimensions

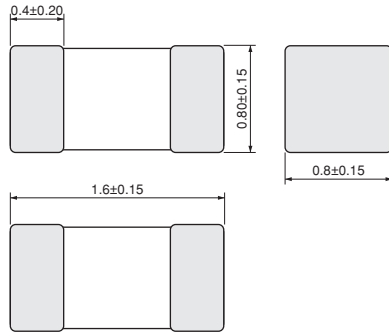

(in mm)

■ Packaging

Code	Packaging	Minimum Quantity
L	ø180mm Embossed Taping	4000
B	Packing in Bulk	1000



Refer to pages 102 to 106 for mounting information.

■ Rated Value (□: packaging code)

Part Number	Inductance	Inductance Test Frequency	Rated Current	DC Resistance	Self-Resonance Frequency (min.)	
LQM18PN1R0NF0□	1.0μH ±30%	1MHz	600mA	0.28Ω ±25%	50MHz	Kit

Class of Magnetic Shield: Magnetic shield of ferrite Operating Temperature Range: -55°C~+125°C

■ Inductance-Frequency Characteristics (Typ.)

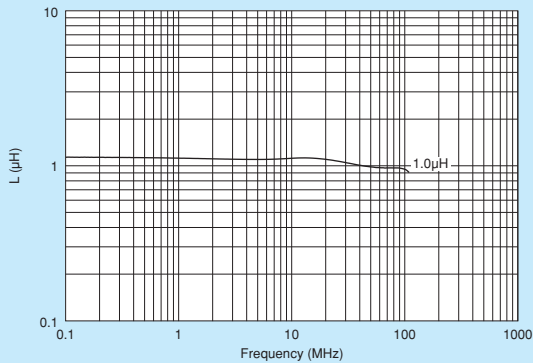

■ Inductance-Current Characteristics (Typ.)

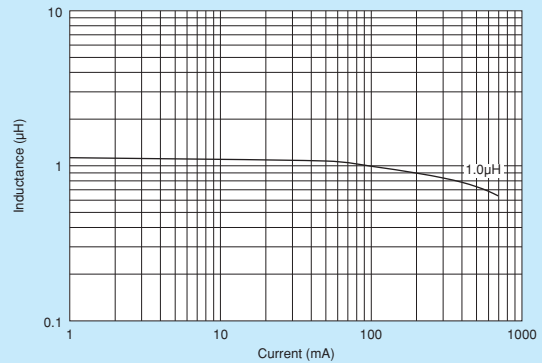

■ Temperature Rise Characteristics (Typ.)

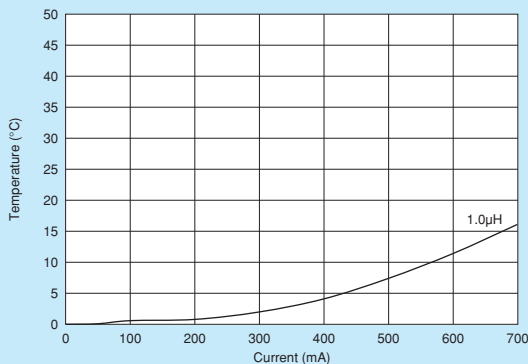

△Note • Please read rating and △CAUTION (for storage, operating, rating, soldering, mounting and handling) in this catalog to prevent smoking and/or burning, etc.
• This catalog has only typical specifications. Therefore, please approve our product specifications or transact the approval sheet for product specifications before ordering.

LQM18PN_FR Series 0603/1608 (inch/mm)

Low DC Resistance Type

Appearance/Dimensions

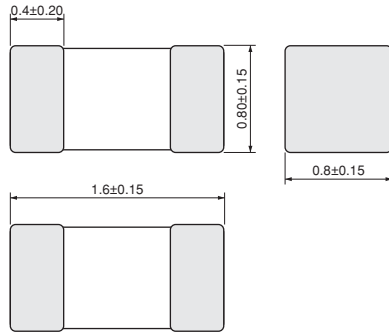

(in mm)

Packaging

Code	Packaging	Minimum Quantity
L	ø180mm Embossed Taping	4000
B	Packing in Bulk	1000

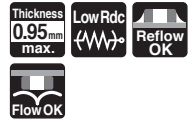

Refer to pages 102 to 106 for mounting information.

Rated Value (□: packaging code)

Part Number	Inductance	Inductance Test Frequency	Rated Current	DC Resistance	Self-Resonance Frequency (min.)	
LQM18PNR22NFR□	0.22μH ±30%	1MHz	1250mA	0.11 Ω ±25%	100MHz	Kit
LQM18PNR47NFR□	0.47μH ±30%	1MHz	1100mA	0.15 Ω ±25%	100MHz	Kit
LQM18PN1R0MFR□	1.0μH ±20%	1MHz	950mA	0.20 Ω ±25%	100MHz	Kit
LQM18PN1R5MFR□	1.5μH ±20%	1MHz	800mA	0.23 Ω ±25%	100MHz	Kit
LQM18PN2R2MFR□	2.2μH ±20%	1MHz	750mA	0.30 Ω ±25%	70MHz	Kit
LQM18PN3R3MFR□	3.3μH ±20%	1MHz	700mA	0.35 Ω ±25%	60MHz	Kit
LQM18PN4R7MFR□	4.7μH ±20%	1MHz	620mA	0.44 Ω ±25%	40MHz	Kit

Class of Magnetic Shield: Magnetic shield of ferrite Operating Temperature Range: -40°C~+85°C

Inductance-Frequency Characteristics (Typ.)

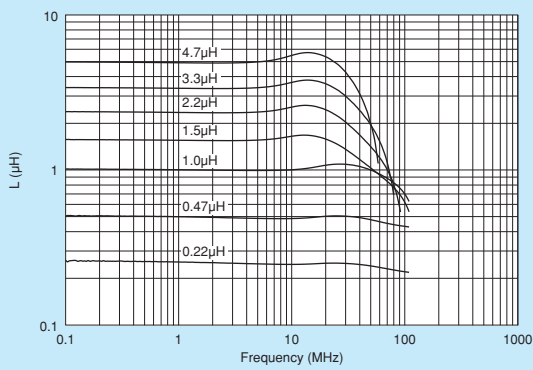

Inductance-Current Characteristics (Typ.)

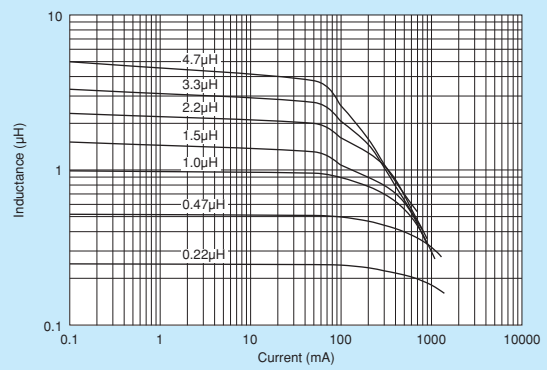

Continued on the following page.

Note • Please read rating and CAUTION (for storage, operating, rating, soldering, mounting and handling) in this catalog to prevent smoking and/or burning, etc.
 • This catalog has only typical specifications. Therefore, please approve our product specifications or transact the approval sheet for product specifications before ordering.

■ Temperature Rise Characteristics (Typ.)

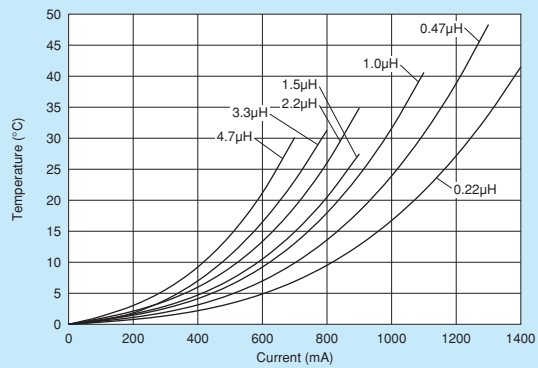

LQM21PN_CO Series 0805/2012 (inch/mm)

Size Code 0805 (2012) in inch (in mm), 0.55mm max. Thickness

■ Appearance/Dimensions

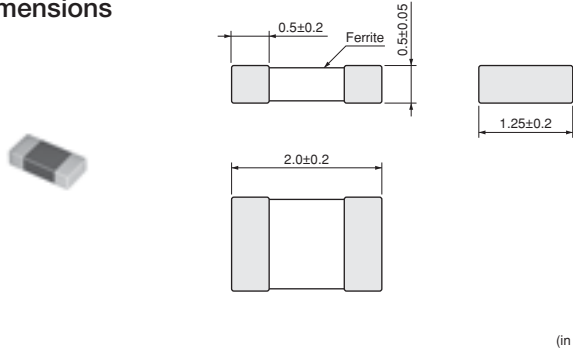

■ Packaging

Code	Packaging	Minimum Quantity
D	ø180mm Paper Taping	4000
B	Packing in Bulk	1000



Refer to pages 102 to 106 for mounting information.

■ Rated Value (□: packaging code)

Part Number	Inductance	Inductance Test Frequency	Rated Current	DC Resistance	Self-Resonance Frequency (min.)	
LQM21PNR47MC0□	0.47μH ±20%	1MHz	1100mA	0.12Ω ±25%	100MHz	Kit
LQM21PN1R0MC0□	1.0μH ±20%	1MHz	800mA	0.19Ω ±25%	90MHz	Kit
LQM21PN1R5MC0□	1.5μH ±20%	1MHz	700mA	0.26Ω ±25%	70MHz	Kit
LQM21PN2R2MC0□	2.2μH ±20%	1MHz	600mA	0.34Ω ±25%	50MHz	Kit

Class of Magnetic Shield: Magnetic shield of ferrite Operating Temperature Range: -55°C~+125°C

■ Inductance-Frequency Characteristics (Typ.)

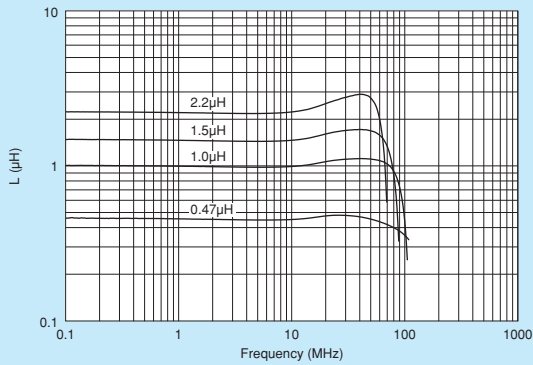

■ Inductance-Current Characteristics (Typ.)

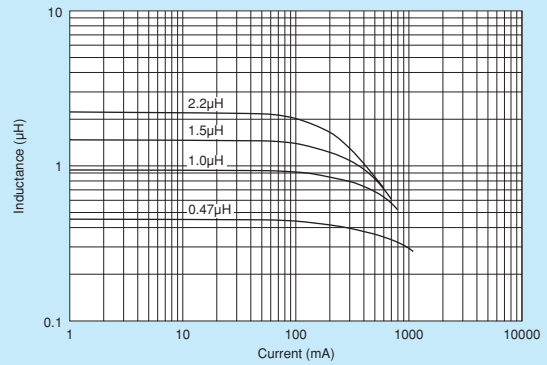

■ Temperature Rise Characteristics (Typ.)

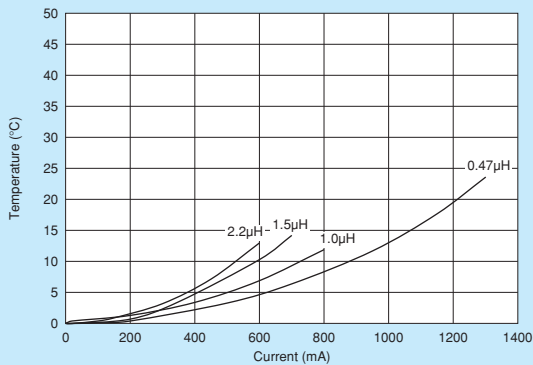

△Note • Please read rating and △CAUTION (for storage, operating, rating, soldering, mounting and handling) in this catalog to prevent smoking and/or burning, etc.
• This catalog has only typical specifications. Therefore, please approve our product specifications or transact the approval sheet for product specifications before ordering.

LQM21PN_G0 Series 0805/2012 (inch/mm)

Size Code 0805 (2012) in inch (in mm), 1.0mm max. Thickness

■ Appearance/Dimensions

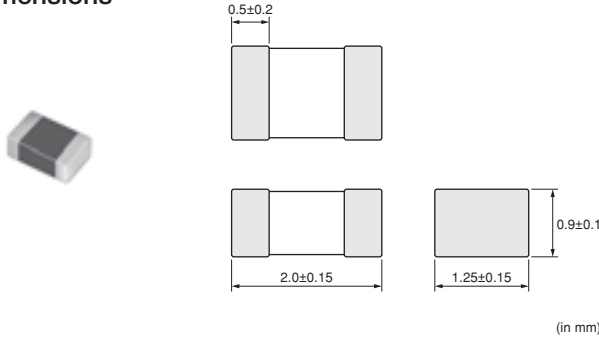

■ Packaging

Code	Packaging	Minimum Quantity
D	ø180mm Paper Taping	4000
B	Packing in Bulk	1000



Refer to pages 102 to 106 for mounting information.

■ Rated Value (□: packaging code)

Part Number	Inductance	Inductance Test Frequency	Rated Current	DC Resistance	Self-Resonance Frequency (min.)	
LQM21PNR47MG0□	0.47μH ±20%	1MHz	1300mA	0.075Ω ±25%	100MHz	Kit
LQM21PNR54MG0□	0.54μH ±20%	1MHz	1300mA	0.075Ω ±25%	100MHz	Kit
LQM21PN3R3MG0□	3.3μH ±20%	1MHz	800mA	0.165Ω ±25%	30MHz	Kit
LQM21PN3R3NG0□	3.3μH ±30%	1MHz	800mA	0.165Ω ±25%	30MHz	

Class of Magnetic Shield: Magnetic shield of ferrite Operating Temperature Range: -55°C~+125°C

■ Inductance-Frequency Characteristics (Typ.)

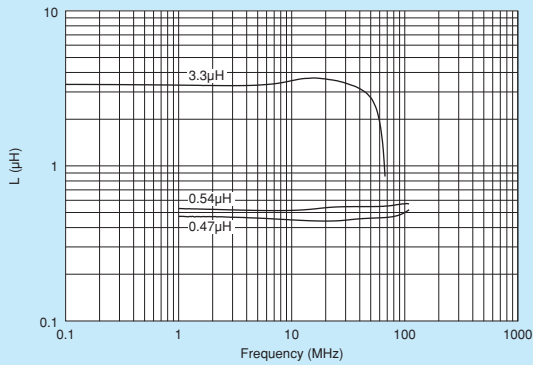

■ Inductance-Current Characteristics (Typ.)

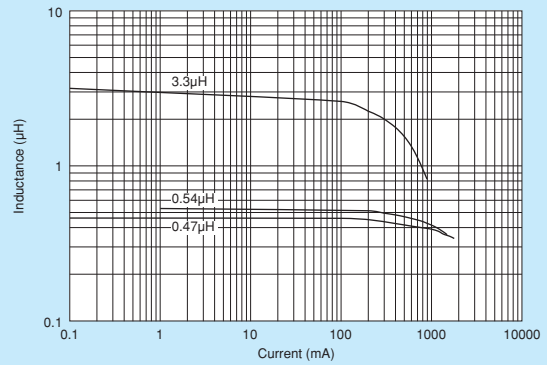

■ Temperature Rise Characteristics (Typ.)

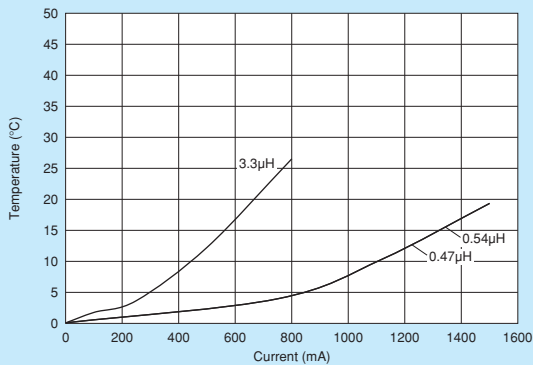

■ Derating of Rated Current

In operating temperature exceeding +85°C, derating of current is necessary for LQM21PN3R3MG0/LQM21PN3R3NG0. Please apply the derating curve shown in the chart according to the operating temperature.

Derating of Rated Current

(LQM21PN3R3MG0/LQM21PN3R3NG0)

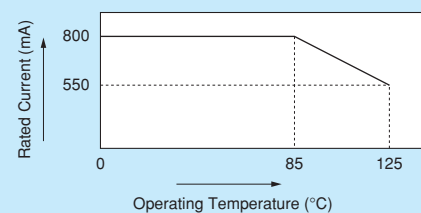

△Note • Please read rating and △CAUTION (for storage, operating, rating, soldering, mounting and handling) in this catalog to prevent smoking and/or burning, etc.
• This catalog has only typical specifications. Therefore, please approve our product specifications or transact the approval sheet for product specifications before ordering.

LQM21PN_GS Series 0805/2012 (inch/mm)

Size Code 0805 (2012) in inch (in mm), 1.0mm max. Thickness

■ Appearance/Dimensions

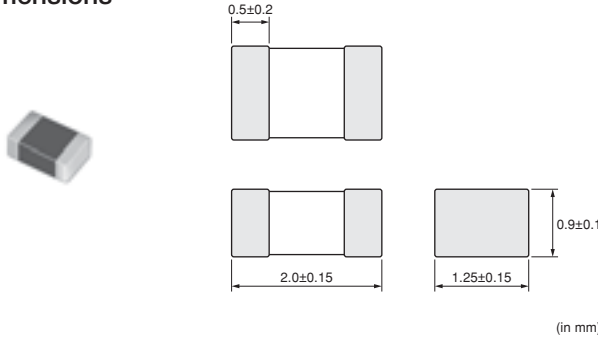

■ Packaging

Code	Packaging	Minimum Quantity
D	ø180mm Paper Taping	4000
B	Packing in Bulk	1000



Refer to pages 102 to 106 for mounting information.

■ Rated Value (□: packaging code)

Part Number	Inductance	Inductance Test Frequency	Rated Current	DC Resistance	Self-Resonance Frequency (min.)	
LQM21PN2R2MGS□	2.2μH ±20%	1MHz	950mA	0.180Ω ±25%	40MHz	Kit
LQM21PN4R7MGS□	4.7μH ±20%	1MHz	750mA	0.290Ω ±25%	20MHz	Kit

Class of Magnetic Shield: Magnetic shield of ferrite Operating Temperature Range: -40°C~+85°C

■ Inductance-Frequency Characteristics (Typ.)

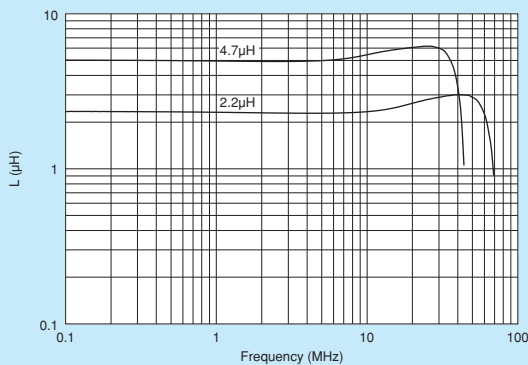

■ Inductance-Current Characteristics (Typ.)

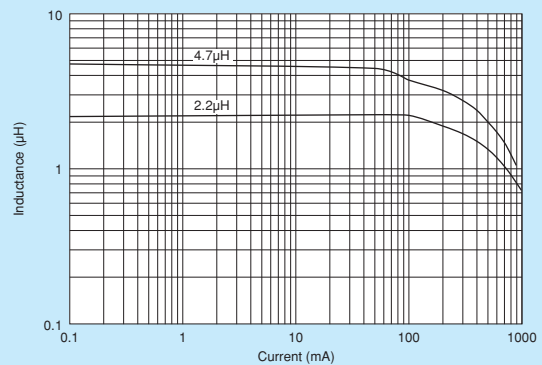

■ Temperature Rise Characteristics (Typ.)

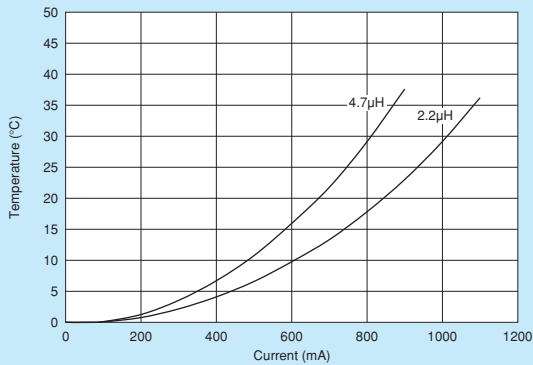

△Note • Please read rating and △CAUTION (for storage, operating, rating, soldering, mounting and handling) in this catalog to prevent smoking and/or burning, etc.
• This catalog has only typical specifications. Therefore, please approve our product specifications or transact the approval sheet for product specifications before ordering.

LQM21PN_GC Series 0805/2012 (inch/mm)

Bias Current Characteristics Improved

Appearance/Dimensions

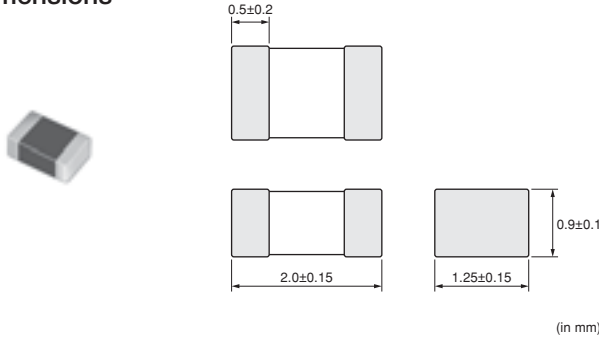

Packaging

Code	Packaging	Minimum Quantity
D	ø180mm Paper Taping	4000
B	Packing in Bulk	1000



Refer to pages 102 to 106 for mounting information.

Rated Value (□: packaging code)

Part Number	Inductance	Inductance Test Frequency	Rated Current	DC Resistance	Self-Resonance Frequency (min.)	
LQM21PN1R0NGC□	1.0μH ±30%	1MHz	900mA	0.10Ω ±25%	50MHz	Kit
LQM21PN2R2NGC□	2.2μH ±30%	1MHz	800mA	0.23Ω ±25%	40MHz	Kit

Class of Magnetic Shield: Magnetic shield of ferrite Operating Temperature Range: -55°C~+125°C

Inductance-Frequency Characteristics (Typ.)

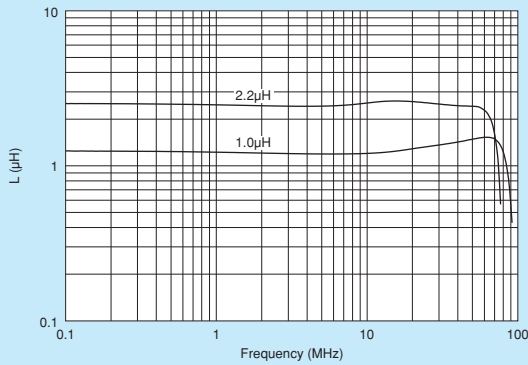

Inductance-Current Characteristics (Typ.)

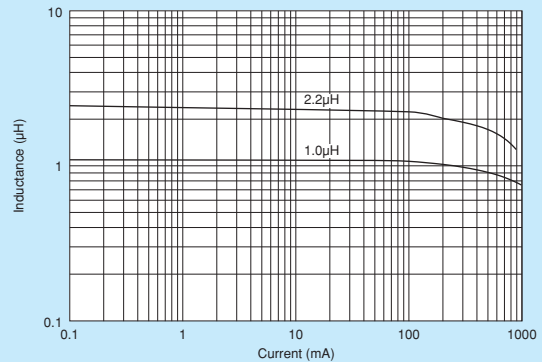

Temperature Rise Characteristics (Typ.)

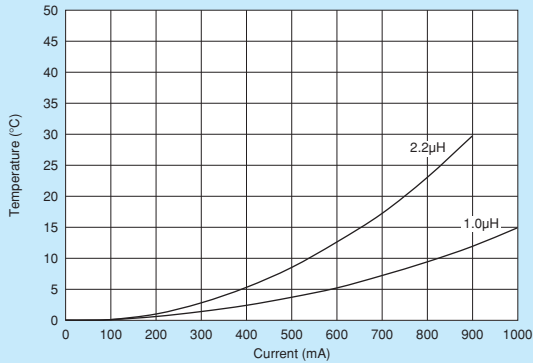

△Note • Please read rating and △CAUTION (for storage, operating, rating, soldering, mounting and handling) in this catalog to prevent smoking and/or burning, etc.
• This catalog has only typical specifications. Therefore, please approve our product specifications or transact the approval sheet for product specifications before ordering.

LQM21PN_GR Series 0805/2012 (inch/mm)

Low DC Resistance Type

Appearance/Dimensions

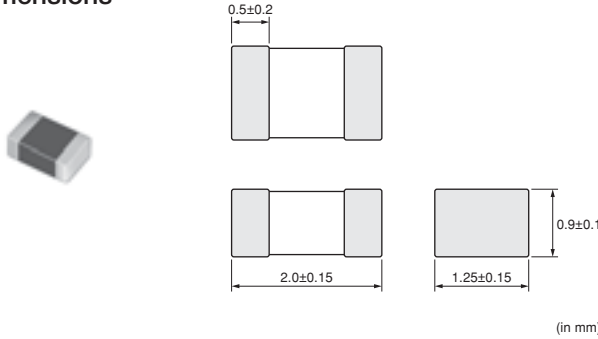

Packaging

Code	Packaging	Minimum Quantity
D	ø180mm Paper Taping	4000
B	Packing in Bulk	1000

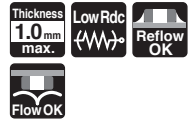

Refer to pages 102 to 106 for mounting information.

Rated Value (□: packaging code)

Part Number	Inductance	Inductance Test Frequency	Rated Current	DC Resistance	Self-Resonance Frequency (min.)	
LQM21PN1R0NGR□	1.0μH ±30%	1MHz	1300mA	0.066Ω ±25%	50MHz	Kit
LQM21PN3R3MGR□	3.3μH ±20%	1MHz	1000mA	0.150Ω ±25%	30MHz	Kit
LQM21PN3R3NGR□	3.3μH ±30%	1MHz	1000mA	0.150Ω ±25%	30MHz	
LQM21PN4R7MGR□	4.7μH ±20%	1MHz	800mA	0.23Ω ±25%	30MHz	Kit
LQM21PN4R7NGR□	4.7μH ±30%	1MHz	800mA	0.23Ω ±25%	30MHz	

Class of Magnetic Shield: Magnetic shield of ferrite Operating Temperature Range: -55°C~+125°C

Inductance-Frequency Characteristics (Typ.)

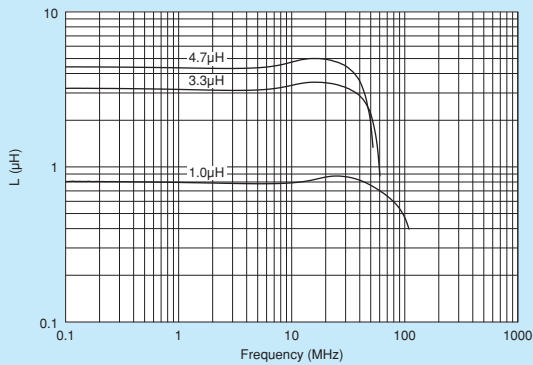

Inductance-Current Characteristics (Typ.)

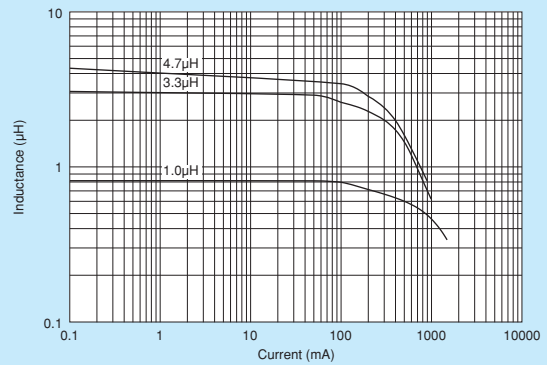

Temperature Rise Characteristics (Typ.)

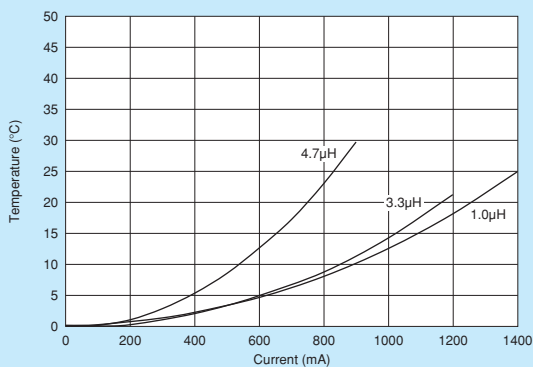

△Note • Please read rating and △CAUTION (for storage, operating, rating, soldering, mounting and handling) in this catalog to prevent smoking and/or burning, etc.
• This catalog has only typical specifications. Therefore, please approve our product specifications or transact the approval sheet for product specifications before ordering.

LQM2MPN_G0 Series 0806/2016 (inch/mm)

Size Code 0806 (2016) in inch (in mm), 1.0mm max. Thickness

■ Appearance/Dimensions

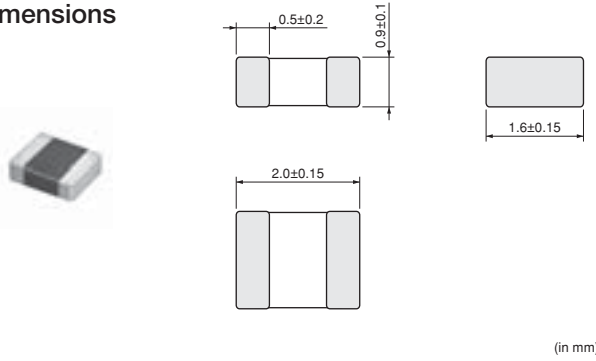

■ Packaging

Code	Packaging	Minimum Quantity
L	ø180mm Embossed Taping	3000
B	Packing in Bulk	1000



Refer to pages 102 to 106 for mounting information.

■ Rated Value (□: packaging code)

Part Number	Inductance	Inductance Test Frequency	Rated Current	DC Resistance	Self-Resonance Frequency (min.)	
LQM2MPNR47MG0□	0.47μH ±20%	1MHz	1600mA	0.060 Ω ±25%	100MHz	Kit
LQM2MPNR47NG0□	0.47μH ±30%	1MHz	1600mA	0.060 Ω ±25%	100MHz	
LQM2MPN1R0NG0□	1.0μH ±30%	1MHz	1400mA	0.085 Ω ±25%	60MHz	Kit
LQM2MPN1R5MG0□	1.5μH ±20%	1MHz	1200mA	0.11 Ω ±25%	50MHz	Kit
LQM2MPN1R5NG0□	1.5μH ±30%	1MHz	1200mA	0.11 Ω ±25%	50MHz	
LQM2MPN2R2MG0□	2.2μH ±20%	1MHz	1200mA	0.11 Ω ±25%	40MHz	Kit
LQM2MPN2R2NG0□	2.2μH ±30%	1MHz	1200mA	0.11 Ω ±25%	40MHz	
LQM2MPN3R3NG0□	3.3μH ±30%	1MHz	1200mA	0.12 Ω ±25%	30MHz	Kit
LQM2MPN4R7MG0□	4.7μH ±20%	1MHz	1100mA	0.14 Ω ±25%	20MHz	Kit
LQM2MPN4R7NG0□	4.7μH ±30%	1MHz	1100mA	0.14 Ω ±25%	20MHz	

Class of Magnetic Shield: Magnetic shield of ferrite Operating Temperature Range: -55°C~+125°C

■ Inductance-Frequency Characteristics (Typ.)

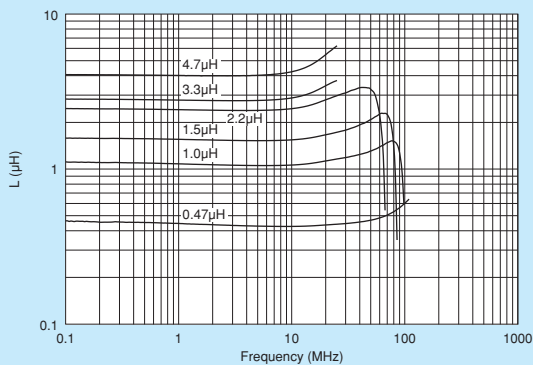

■ Inductance-Current Characteristics (Typ.)

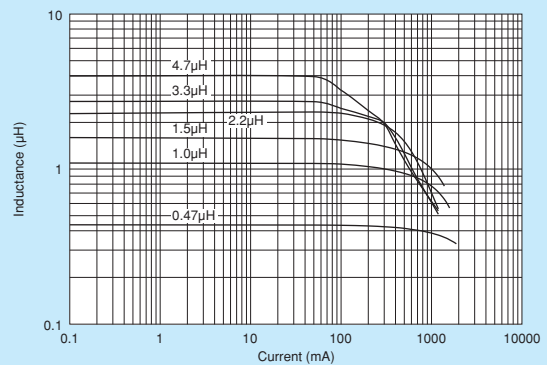

Continued on the following page.

△Note • Please read rating and △CAUTION (for storage, operating, rating, soldering, mounting and handling) in this catalog to prevent smoking and/or burning, etc.
• This catalog has only typical specifications. Therefore, please approve our product specifications or transact the approval sheet for product specifications before ordering.

■ Temperature Rise Characteristics (Typ.)

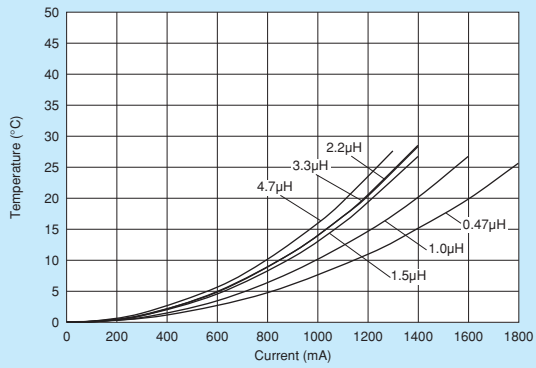

⚠Note • Please read rating and ⚠CAUTION (for storage, operating, rating, soldering, mounting and handling) in this catalog to prevent smoking and/or burning, etc.
• This catalog has only typical specifications. Therefore, please approve our product specifications or transact the approval sheet for product specifications before ordering.

LQM2MPN_GH Series 0806/2016 (inch/mm)

High Spec Type (Low DC Resistance / Good Bias Current Characteristics Type)

■ Appearance/Dimensions

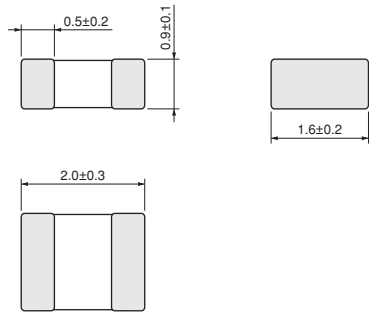

(in mm)

■ Packaging

Code	Packaging	Minimum Quantity
L	ø180mm Embossed Taping	3000

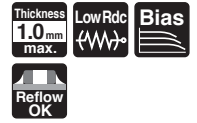

Refer to pages 102 to 106 for mounting information.

■ Rated Value (□: packaging code)

Part Number	Inductance	Rated Current ^{*1*3} (Based on Inductance Change)	Rated Current ^{*2*3} (Based on Temperature Rise)	Max. of DC Resistance	Self-Resonance Frequency (min.)	
LQM2MPNR16MGH□	0.16μH ±20%	5.0A(Max)/5.5A(Typ.)	4.0A(Max)/5.0A(Typ.)	18mΩ (Max)/14mΩ (Typ.)	150MHz	New
LQM2MPNR24MGH□	0.24μH ±20%	4.8A(Max)/5.0A(Typ.)	3.4A(Max)/4.4A(Typ.)	25mΩ (Max)/20mΩ (Typ.)	130MHz	New
LQM2MPNR33MGH□	0.33μH ±20%	3.7A(Max)/3.9A(Typ.)	3.1A(Max)/4.0A(Typ.)	30mΩ (Max)/24mΩ (Typ.)	90MHz	New
LQM2MPNR47MGH□	0.47μH ±20%	3.4A(Max)/3.6A(Typ.)	2.5A(Max)/3.2A(Typ.)	46mΩ (Max)/37mΩ (Typ.)	80MHz	New
LQM2MPNR68MGH□	0.68μH ±20%	3.1A(Max)/3.4A(Typ.)	1.9A(Max)/2.5A(Typ.)	75mΩ (Max)/60mΩ (Typ.)	60MHz	New
LQM2MPN1R0MGH□	1.0μH ±20%	2.0A(Max)/2.3A(Typ.)	1.9A(Max)/2.4A(Typ.)	80mΩ (Max)/64mΩ (Typ.)	60MHz	New
LQM2MPN1R5MGH□	1.5μH ±20%	1.8A(Max)/2.0A(Typ.)	1.5A(Max)/1.9A(Typ.)	130mΩ (Max)/104mΩ (Typ.)	50MHz	New
LQM2MPN2R2MGH□	2.2μH ±20%	1.3A(Max)/1.5A(Typ.)	1.0A(Max)/1.3A(Typ.)	263mΩ (Max)/210mΩ (Typ.)	40MHz	New

Inductance Test Frequency: 1MHz Class of Magnetic Shield: Magnetic shield of ferrite

Operating Temperature Range: -40°C~+85°C

For reflow soldering only.

*1 When applied rated current to the products, inductance will be within -30% of initial inductance value. Typical value is actual performance.

*2 When applied rated current to the products, temperature rise caused by self heating will be 40°C or less. Typical value is actual performance.

*3 Keep the temperature of product (ambient temperature plus self-generation of heat) under 125°C.

■ Inductance-Frequency Characteristics (Typ.)

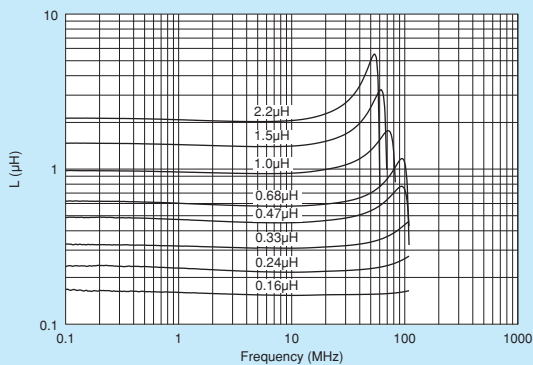

■ Inductance-Current Characteristics (Typ.)

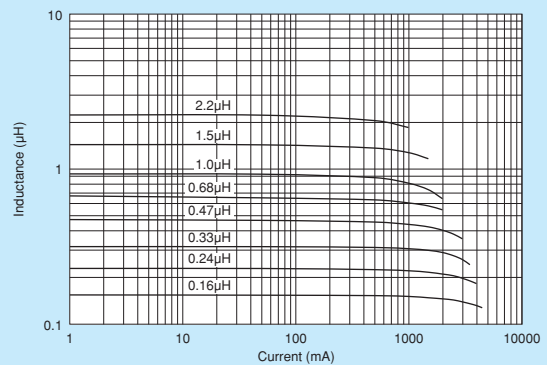

Continued on the following page.

⚠Note • Please read rating and ⚠CAUTION (for storage, operating, rating, soldering, mounting and handling) in this catalog to prevent smoking and/or burning, etc.
• This catalog has only typical specifications. Therefore, please approve our product specifications or transact the approval sheet for product specifications before ordering.

Temperature Rise Characteristics (Typ.)

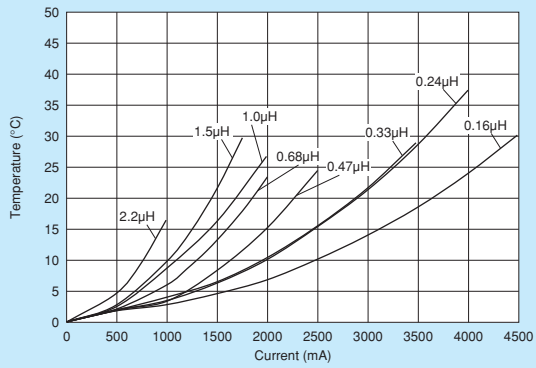

⚠Note • Please read rating and ⚠CAUTION (for storage, operating, rating, soldering, mounting and handling) in this catalog to prevent smoking and/or burning, etc.
• This catalog has only typical specifications. Therefore, please approve our product specifications or transact the approval sheet for product specifications before ordering.

LQM2HPN_J0 Series 1008/2520 (inch/mm)

Size Code 1008 (2520) in inch (in mm), 1.2mm max. Thickness

■ Appearance/Dimensions

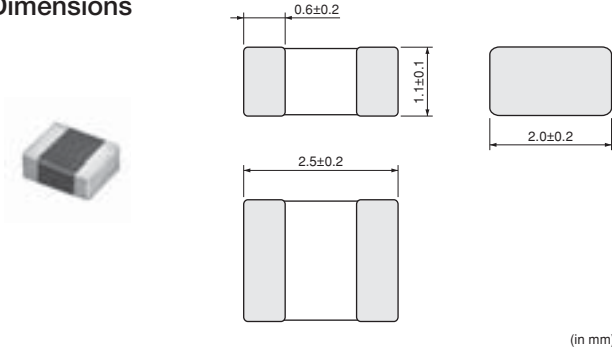

■ Packaging

Code	Packaging	Minimum Quantity
L	ø180mm Embossed Taping	3000
B	Packing in Bulk	1000



Refer to pages 102 to 106 for mounting information.

■ Rated Value (□: packaging code)

Part Number	Inductance	Inductance Test Frequency	Rated Current	DC Resistance	Self-Resonance Frequency (min.)	
LQM2HPN1R0MJ0□	1.0μH ±20%	1MHz	1500mA	0.09Ω ±25%	70MHz	Kit
LQM2HPN2R2MJ0□	2.2μH ±20%	1MHz	1000mA	0.12Ω ±25%	40MHz	Kit
LQM2HPN3R3MJ0□	3.3μH ±20%	1MHz	1000mA	0.12Ω ±25%	30MHz	Kit

Class of Magnetic Shield: Magnetic shield of ferrite Operating Temperature Range: -55°C~+125°C

■ Inductance-Frequency Characteristics (Typ.)

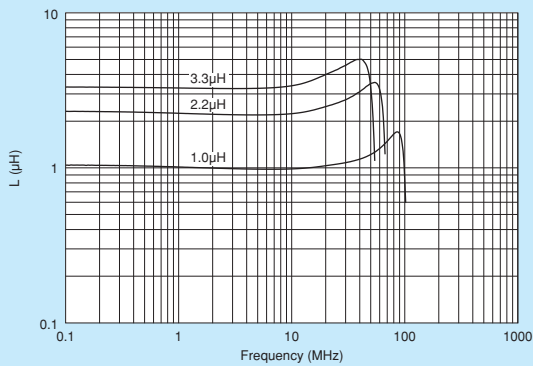

■ Inductance-Current Characteristics (Typ.)

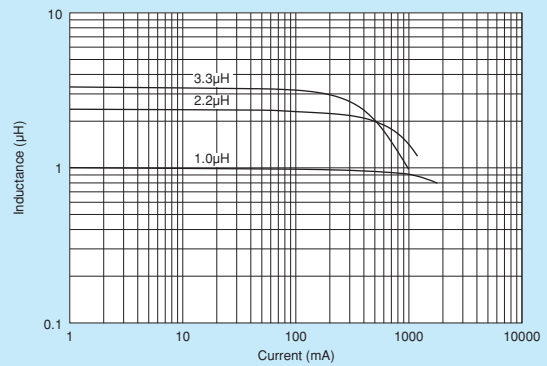

■ Temperature Rise Characteristics (Typ.)

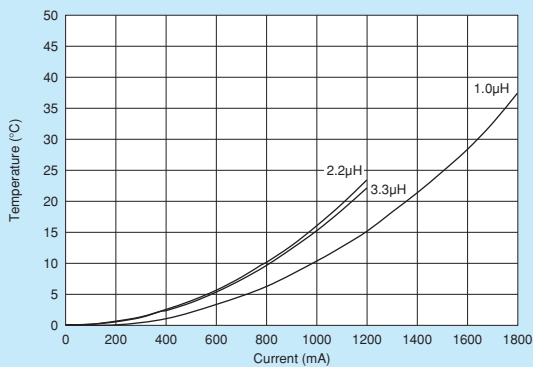

△Note • Please read rating and △CAUTION (for storage, operating, rating, soldering, mounting and handling) in this catalog to prevent smoking and/or burning, etc.
 • This catalog has only typical specifications. Therefore, please approve our product specifications or transact the approval sheet for product specifications before ordering.

LQM2HPN_JH Series 1008/2520 (inch/mm)

High Spec Type (Low DC Resistance / Good Bias Current Characteristics Type)

Appearance/Dimensions

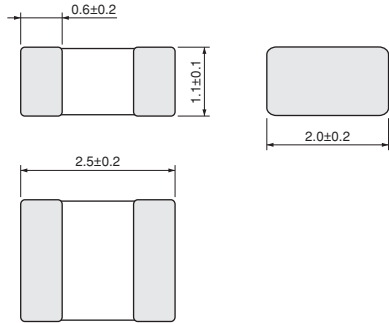

(in mm)

Packaging

Code	Packaging	Minimum Quantity
L	ø180mm Embossed Taping	3000

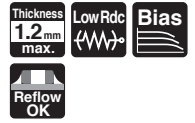

Refer to pages 102 to 106 for mounting information.

Rated Value (□: packaging code)

Part Number	Inductance	Rated Current ^{*1*3} (Based on Inductance Change)	Rated Current ^{*2*3} (Based on Temperature Rise)	Max. of DC Resistance	Self-Resonance Frequency (min.)	
LQM2HPNR47MJH□	0.47μH ±20%	3.2A(Max)/3.5A(Typ.)	2.7A(Max)/3.4A(Typ.)	46mΩ (Max)/37mΩ (Typ.)	70MHz	New
LQM2HPN1R0MJH□	1.0μH ±20%	2.1A(Max)/2.4A(Typ.)	2.3A(Max)/2.9A(Typ.)	63mΩ (Max)/50mΩ (Typ.)	50MHz	New
LQM2HPN2R2MJH□	2.2μH ±20%	1.4A(Max)/1.6A(Typ.)	1.5A(Max)/1.9A(Typ.)	138mΩ (Max)/110mΩ (Typ.)	30MHz	New

Inductance Test Frequency: 1MHz Class of Magnetic Shield: Magnetic shield of ferrite
 Operating Temperature Range: -40°C~+85°C
 For reflow soldering only.

*1 When applied rated current to the products, inductance will be within -30% of initial inductance value. Typical value is actual performance.

*2 When applied rated current to the products, temperature rise caused by self heating will be 40°C or less. Typical value is actual performance.

*3 Keep the temperature of product (ambient temperature plus self-generation of heat) under 125°C.

Inductance-Frequency Characteristics (Typ.)

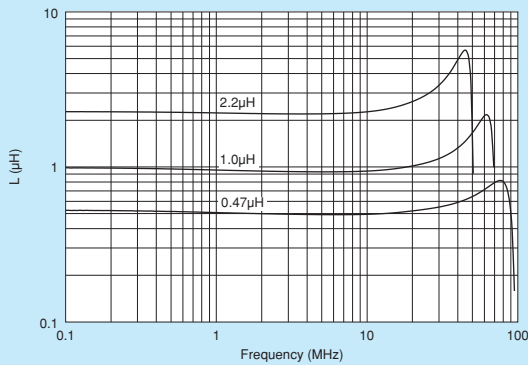

Inductance-Current Characteristics (Typ.)

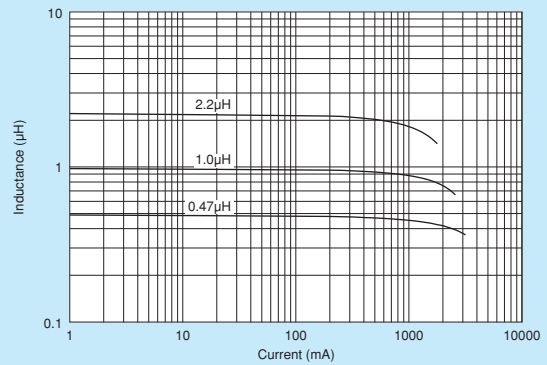

Temperature Rise Characteristics (Typ.)

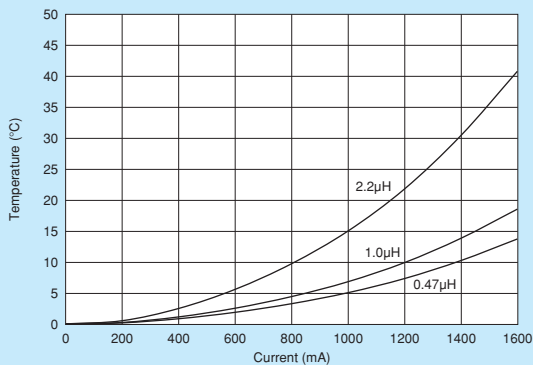

△Note • Please read rating and △CAUTION (for storage, operating, rating, soldering, mounting and handling) in this catalog to prevent smoking and/or burning, etc.
 • This catalog has only typical specifications. Therefore, please approve our product specifications or transact the approval sheet for product specifications before ordering.

LQM2HPN_JC Series 1008/2520 (inch/mm)

Bias Current Characteristics Improved

Appearance/Dimensions

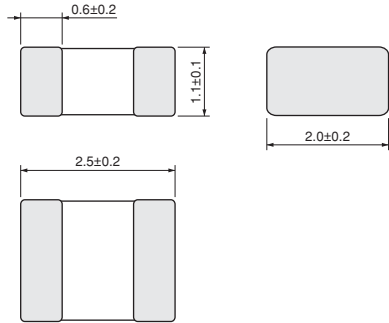

(in mm)

Packaging

Code	Packaging	Minimum Quantity
L	ø180mm Embossed Taping	3000
B	Packing in Bulk	1000



Refer to pages 102 to 106 for mounting information.

Rated Value (□: packaging code)

Part Number	Inductance	Inductance Test Frequency	Rated Current	DC Resistance	Self-Resonance Frequency (min.)	
LQM2HPN1R0MJC□	1.0μH ±20%	1MHz	1500mA	0.086Ω ±25%	50MHz	Kit
LQM2HPN2R2NJC□	2.2μH ±30%	1MHz	1000mA	0.175Ω ±25%	30MHz	Kit

Class of Magnetic Shield: Magnetic shield of ferrite Operating Temperature Range: -55°C~+125°C

Inductance-Frequency Characteristics (Typ.)

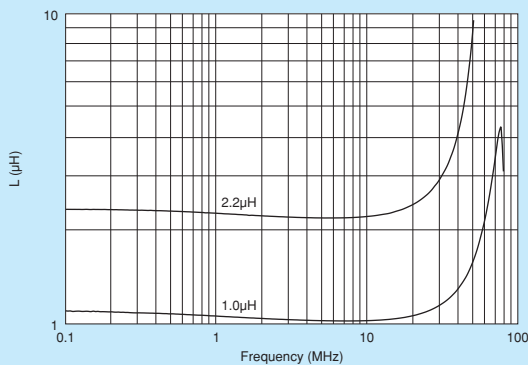

Inductance-Current Characteristics (Typ.)

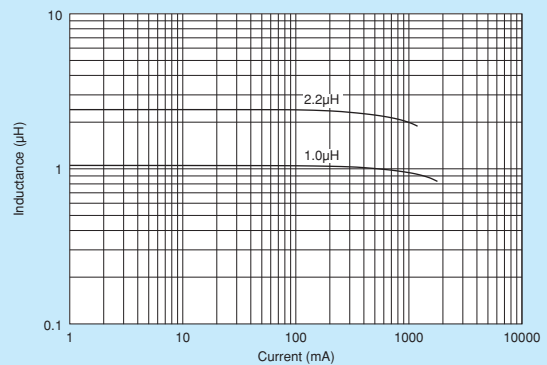

Temperature Rise Characteristics (Typ.)

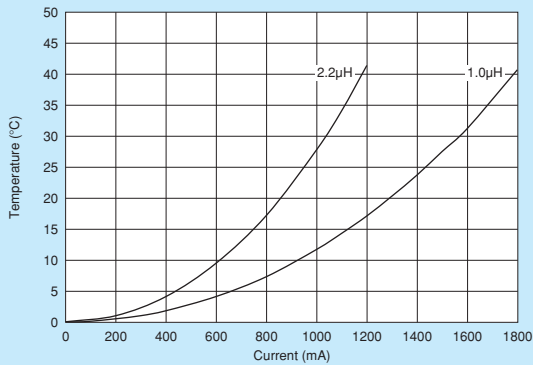

△Note • Please read rating and △CAUTION (for storage, operating, rating, soldering, mounting and handling) in this catalog to prevent smoking and/or burning, etc.
• This catalog has only typical specifications. Therefore, please approve our product specifications or transact the approval sheet for product specifications before ordering.

LQM2HPN_G0 Series 1008/2520 (inch/mm)

Size Code 1008 (2520) in inch (in mm), 1.0mm max. Thickness

■ Appearance/Dimensions

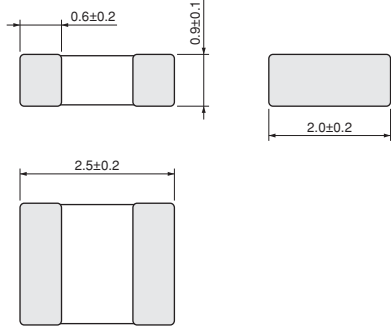

(in mm)

■ Packaging

Code	Packaging	Minimum Quantity
L	ø180mm Embossed Taping	3000
B	Packing in Bulk	1000



Refer to pages 102 to 106 for mounting information.

■ Rated Value (□: packaging code)

Part Number	Inductance	Inductance Test Frequency	Rated Current	DC Resistance	Self-Resonance Frequency (min.)	
LQM2HPNR47MG0□	0.47μH ±20%	1MHz	1800mA	0.04 Ω ±25%	100MHz	Kit
LQM2HPN1R0MG0□	1.0μH ±20%	1MHz	1600mA	0.055 Ω ±25%	60MHz	Kit
LQM2HPN1R5MG0□	1.5μH ±20%	1MHz	1500mA	0.07 Ω ±25%	50MHz	Kit
LQM2HPN2R2MG0□	2.2μH ±20%	1MHz	1300mA	0.08 Ω ±25%	40MHz	Kit
LQM2HPN3R3MG0□	3.3μH ±20%	1MHz	1200mA	0.10 Ω ±25%	30MHz	Kit
LQM2HPN4R7MG0□	4.7μH ±20%	1MHz	1100mA	0.11 Ω ±25%	25MHz	Kit

Class of Magnetic Shield: Magnetic shield of ferrite Operating Temperature Range: -55°C~+125°C

■ Inductance-Frequency Characteristics (Typ.)

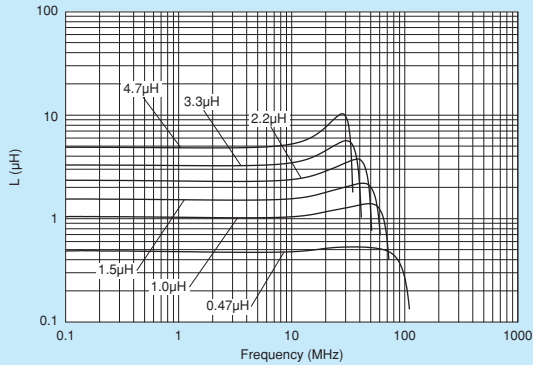

■ Inductance-Current Characteristics (Typ.)

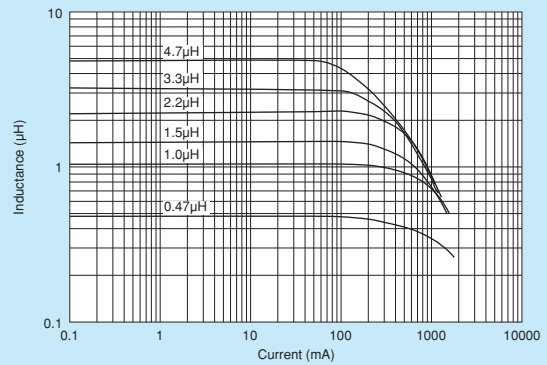

■ Temperature Rise Characteristics (Typ.)

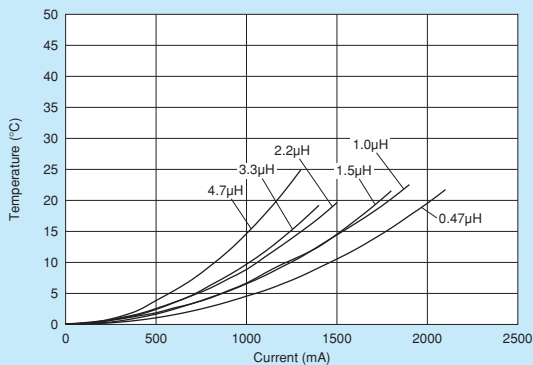

△Note • Please read rating and △CAUTION (for storage, operating, rating, soldering, mounting and handling) in this catalog to prevent smoking and/or burning, etc.
• This catalog has only typical specifications. Therefore, please approve our product specifications or transact the approval sheet for product specifications before ordering.

LQM2HPN_GS Series 1008/2520 (inch/mm)

Size Code 1008 (2520) in inch (in mm), 1.0mm max. Thickness

■ Appearance/Dimensions

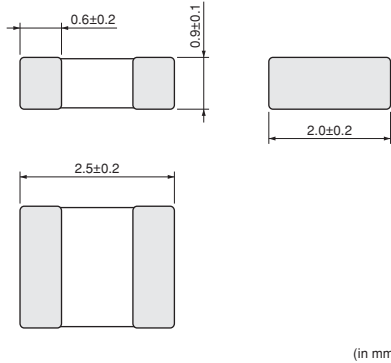

■ Packaging

Code	Packaging	Minimum Quantity
L	ø180mm Embossed Taping	3000
B	Packing in Bulk	1000



Refer to pages 102 to 106 for mounting information.

■ Rated Value (□: packaging code)

Part Number	Inductance	Inductance Test Frequency	Rated Current	DC Resistance	Self-Resonance Frequency (min.)	
LQM2HPN2R2MGS□	2.2μH ±20%	1MHz	1100mA	0.18Ω ±25%	40MHz	Kit
LQM2HPN3R3MGS□	3.3μH ±20%	1MHz	1050mA	0.21Ω ±25%	20MHz	Kit
LQM2HPN4R7MGS□	4.7μH ±20%	1MHz	1000mA	0.25Ω ±25%	20MHz	Kit

Class of Magnetic Shield: Magnetic shield of ferrite Operating Temperature Range: -40°C~+85°C

■ Inductance-Frequency Characteristics (Typ.)

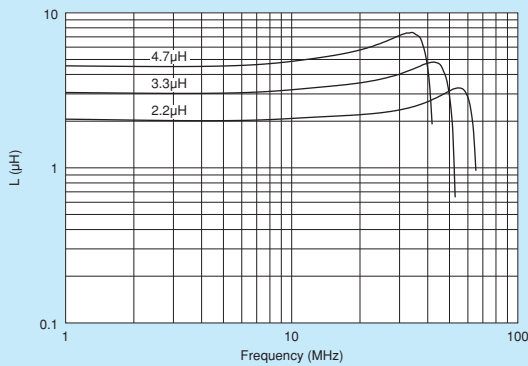

■ Inductance-Current Characteristics (Typ.)

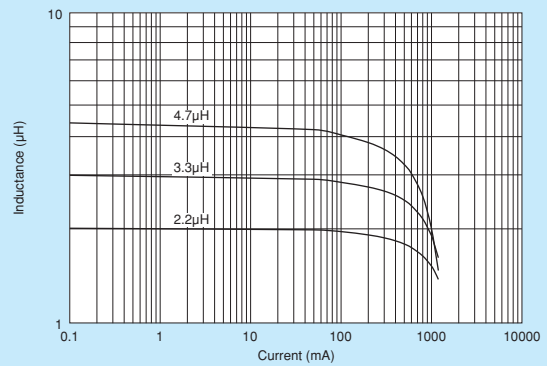

■ Temperature Rise Characteristics (Typ.)

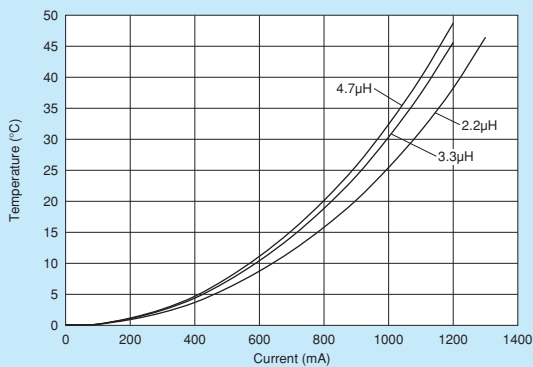

△Note • Please read rating and △CAUTION (for storage, operating, rating, soldering, mounting and handling) in this catalog to prevent smoking and/or burning, etc.
• This catalog has only typical specifications. Therefore, please approve our product specifications or transact the approval sheet for product specifications before ordering.

LQM2HPN_GC Series 1008/2520 (inch/mm)

Bias Current Characteristics Improved

Appearance/Dimensions

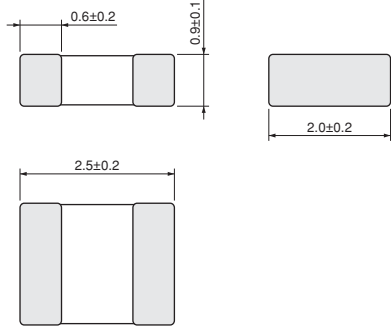

(in mm)

Packaging

Code	Packaging	Minimum Quantity
L	ø180mm Embossed Taping	3000
B	Packing in Bulk	1000



Refer to pages 102 to 106 for mounting information.

Rated Value (□: packaging code)

Part Number	Inductance	Inductance Test Frequency	Rated Current	DC Resistance	Self-Resonance Frequency (min.)	Operating Temperature Range	
LQM2HPN1R0MGC□	1.0μH ±20%	1MHz	1500mA	0.08Ω ±25%	50MHz	-30°C~+85°C	Kit
LQM2HPN3R3MGC□	3.3μH ±20%	1MHz	1000mA	0.16Ω ±25%	30MHz	-55°C~+125°C	Kit
LQM2HPN4R7MGC□	4.7μH ±20%	1MHz	800mA	0.18Ω ±25%	25MHz	-55°C~+125°C	Kit

Class of Magnetic Shield: Magnetic shield of ferrite

Inductance-Frequency Characteristics (Typ.)

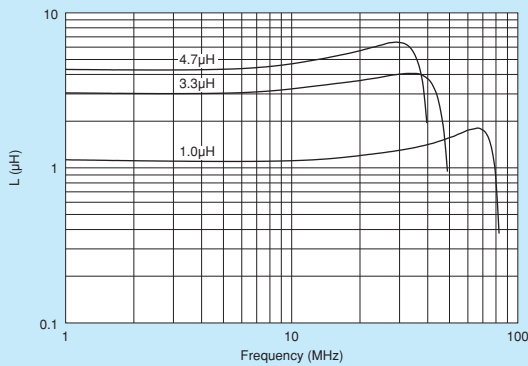

Inductance-Current Characteristics (Typ.)

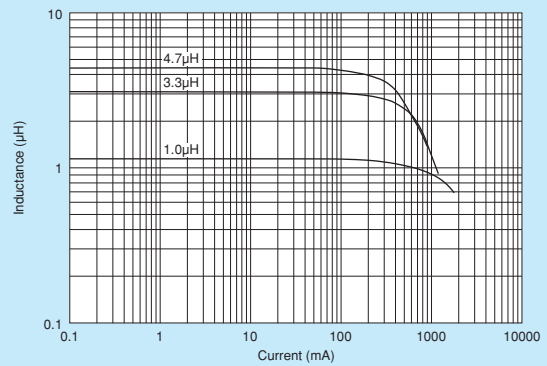

Temperature Rise Characteristics (Typ.)

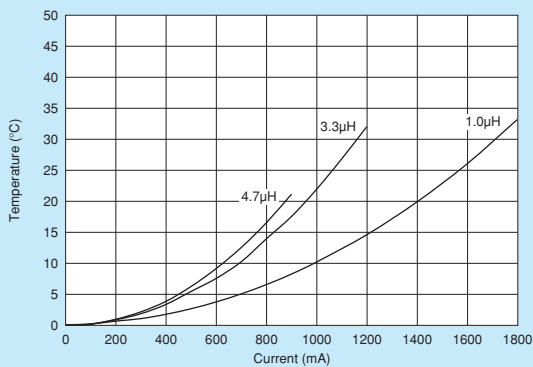

Note • Please read rating and CAUTION (for storage, operating, rating, soldering, mounting and handling) in this catalog to prevent smoking and/or burning, etc.
 • This catalog has only typical specifications. Therefore, please approve our product specifications or transact the approval sheet for product specifications before ordering.

LQM2HPN_GH Series 1008/2520 (inch/mm)

High Spec Type (Low DC Resistance / Good Bias Current Characteristics Type)

■ Appearance/Dimensions

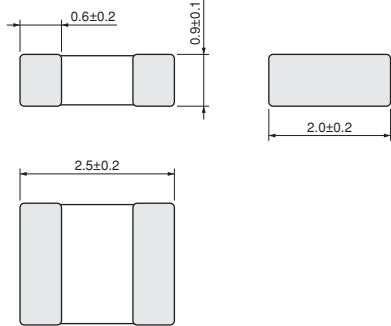

(in mm)

■ Packaging

Code	Packaging	Minimum Quantity
L	ø180mm Embossed Taping	3000

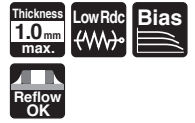

Refer to pages 102 to 106 for mounting information.

■ Rated Value (□: packaging code)

Part Number	Inductance	Rated Current ^{*1*3} (Based on Inductance Change)	Rated Current ^{*2*3} (Based on Temperature Rise)	Max. of DC Resistance	Self-Resonance Frequency (min.)	
LQM2HPNR47MGH□	0.47μH ±20%	4.5A(Max)/4.8A(Typ.)	2.6A(Max)/3.3A(Typ.)	50mΩ (Max)/40mΩ (Typ.)	80MHz	New
LQM2HPNR68MGH□	0.68μH ±20%	4.0A(Max)/3.8A(Typ.)	2.3A(Max)/2.9A(Typ.)	63mΩ (Max)/50mΩ (Typ.)	60MHz	New
LQM2HPN1R0MGH□	1.0μH ±20%	2.0A(Max)/2.3A(Typ.)	2.3A(Max)/2.9A(Typ.)	63mΩ (Max)/50mΩ (Typ.)	50MHz	New
LQM2HPN1R5MGH□	1.5μH ±20%	1.5A(Max)/1.6A(Typ.)	2.0A(Max)/2.6A(Typ.)	81mΩ (Max)/65mΩ (Typ.)	40MHz	New
LQM2HPN2R2MGH□	2.2μH ±20%	1.5A(Max)/1.6A(Typ.)	1.5A(Max)/1.9A(Typ.)	138mΩ (Max)/110mΩ (Typ.)	30MHz	New

Inductance Test Frequency: 1MHz Class of Magnetic Shield: Magnetic shield of ferrite Operating Temperature Range: -40°C~+85°C For reflow soldering only.

*1 When applied rated current to the products, inductance will be within -30% of initial inductance value. Typical value is actual performance.

*2 When applied rated current to the products, temperature rise caused by self heating will be 40°C or less. Typical value is actual performance.

*3 Keep the temperature of product (ambient temperature plus self-generation of heat) under 125°C.

■ Inductance-Frequency Characteristics (Typ.)

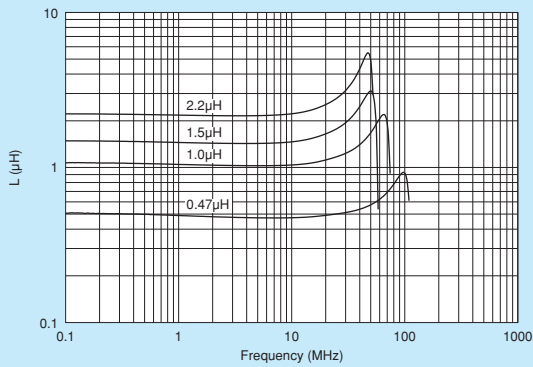

■ Inductance-Current Characteristics (Typ.)

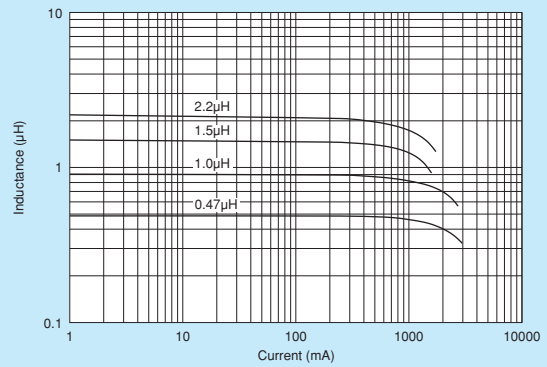

■ Temperature Rise Characteristics (Typ.)

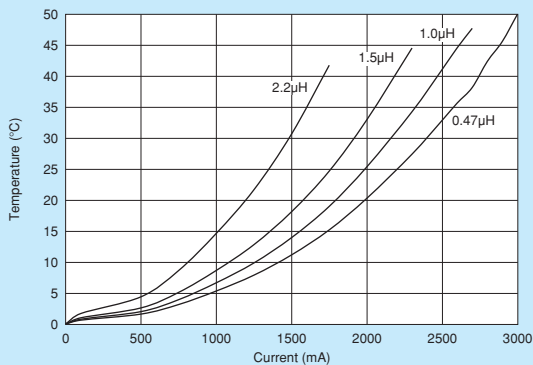

△Note • Please read rating and △CAUTION (for storage, operating, rating, soldering, mounting and handling) in this catalog to prevent smoking and/or burning, etc.
• This catalog has only typical specifications. Therefore, please approve our product specifications or transact the approval sheet for product specifications before ordering.

LQM2HPN_E0 Series 1008/2520 (inch/mm)

Size Code 1008 (2520) in inch (in mm), 0.8mm max. Thickness

■ Appearance/Dimensions

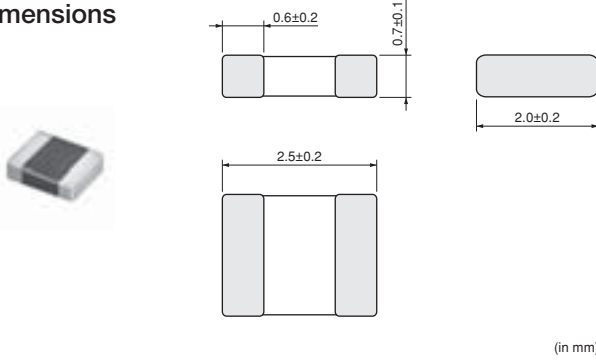

■ Packaging

Code	Packaging	Minimum Quantity
L	ø180mm Embossed Taping	3000
B	Packing in Bulk	1000



Refer to pages 102 to 106 for mounting information.

■ Rated Value (□: packaging code)

Part Number	Inductance	Inductance Test Frequency	Rated Current	DC Resistance	Self-Resonance Frequency (min.)	
LQM2HPNR56ME0□	0.56μH ±20%	1MHz	1500mA	0.06Ω ±25%	70MHz	Kit

Class of Magnetic Shield: Magnetic shield of ferrite Operating Temperature Range: -55°C~+125°C

■ Inductance-Frequency Characteristics (Typ.)

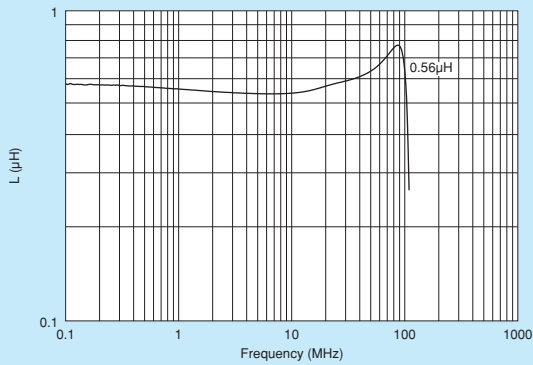

■ Inductance-Current Characteristics (Typ.)

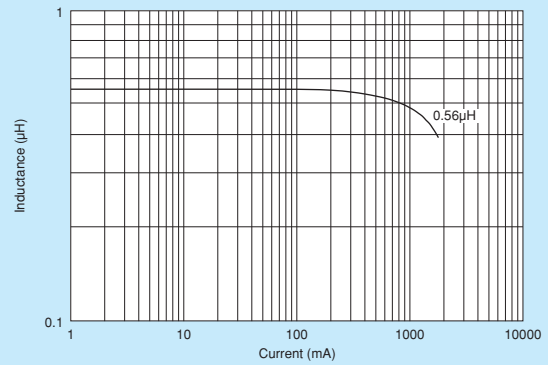

■ Temperature Rise Characteristics (Typ.)

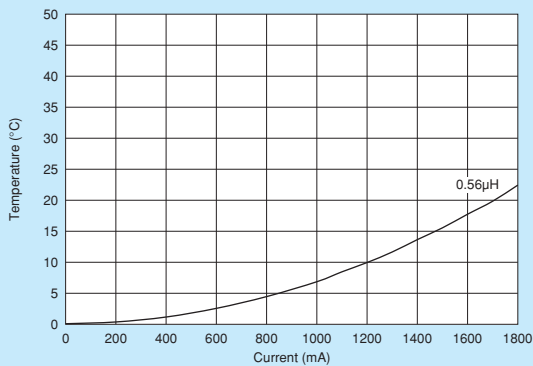

⚠Note • Please read rating and ⚠CAUTION (for storage, operating, rating, soldering, mounting and handling) in this catalog to prevent smoking and/or burning, etc.
• This catalog has only typical specifications. Therefore, please approve our product specifications or transact the approval sheet for product specifications before ordering.

Inductors for Power Lines
Multilayer Type (Ferrite Core)

Inductors for General Use

RF Inductors

LQM31PN_00 Series 1206/3216 (inch/mm)

Size Code 1206 (3216) in inch (in mm), 0.95mm max. Thickness

■ Appearance/Dimensions

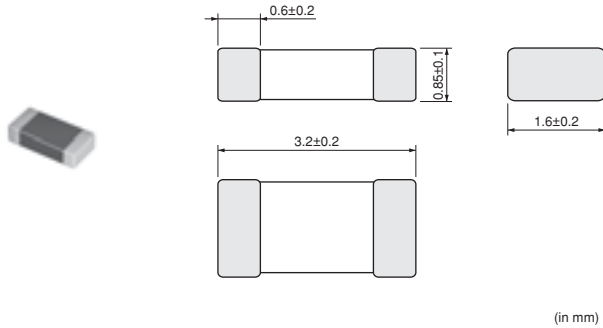

■ Packaging

Code	Packaging	Minimum Quantity
L	ø180mm Embossed Taping	3000
B	Packing in Bulk	1000



Refer to pages 102 to 106 for mounting information.

■ Rated Value (□: packaging code)

Part Number	Inductance	Inductance Test Frequency	Rated Current	DC Resistance	Self-Resonance Frequency (min.)	
LQM31PNR47M00□	0.47μH ±20%	1MHz	1400mA	0.07 Ω ±25%	80MHz	Kit
LQM31PN1R0M00□	1.0μH ±20%	1MHz	1200mA	0.12 Ω ±25%	60MHz	Kit
LQM31PN1R5M00□	1.5μH ±20%	1MHz	1000mA	0.14 Ω ±25%	50MHz	Kit
LQM31PN2R2M00□	2.2μH ±20%	1MHz	900mA	0.19 Ω ±25%	40MHz	Kit
LQM31PN3R3M00□	3.3μH ±20%	1MHz	800mA	0.24 Ω ±25%	30MHz	Kit
LQM31PN4R7M00□	4.7μH ±20%	1MHz	700mA	0.30 Ω ±25%	25MHz	Kit

Class of Magnetic Shield: Magnetic shield of ferrite Operating Temperature Range: -55°C~+125°C

■ Inductance-Frequency Characteristics (Typ.)

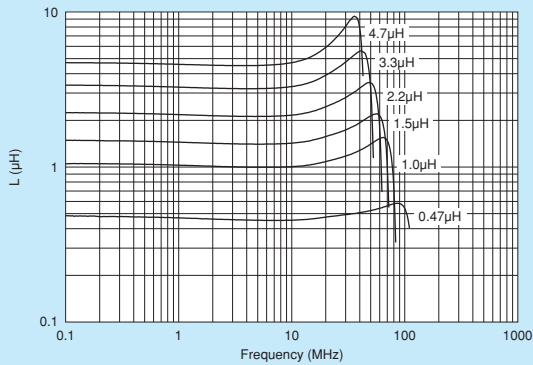

■ Inductance-Current Characteristics (Typ.)

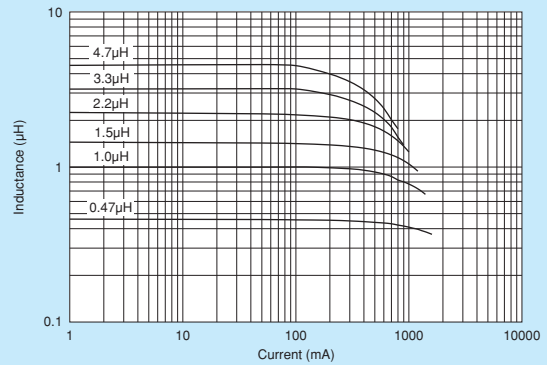

■ Temperature Rise Characteristics (Typ.)

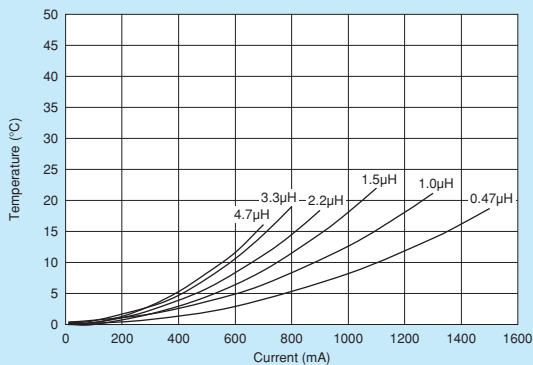

△Note • Please read rating and △CAUTION (for storage, operating, rating, soldering, mounting and handling) in this catalog to prevent smoking and/or burning, etc.
• This catalog has only typical specifications. Therefore, please approve our product specifications or transact the approval sheet for product specifications before ordering.

LQM31PN_CO Series 1206/3216 (inch/mm)

Size Code 1206 (3216) in inch (in mm), 0.55mm max. Thickness

■ Appearance/Dimensions

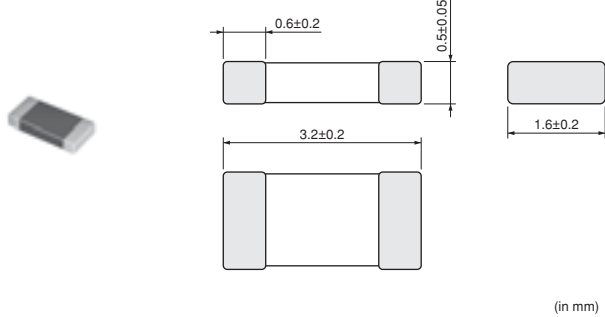

■ Packaging

Code	Packaging	Minimum Quantity
L	ø180mm Embossed Taping	4000
B	Packing in Bulk	1000



Refer to pages 102 to 106 for mounting information.

■ Rated Value (□: packaging code)

Part Number	Inductance	Inductance Test Frequency	Rated Current	DC Resistance	Self-Resonance Frequency (min.)	
LQM31PNR47MC0□	0.47μH ±20%	1MHz	1300mA	0.085Ω ±25%	90MHz	Kit
LQM31PN1R0MC0□	1.0μH ±20%	1MHz	1100mA	0.14Ω ±25%	70MHz	Kit
LQM31PN1R5MC0□	1.5μH ±20%	1MHz	1000mA	0.17Ω ±25%	60MHz	Kit
LQM31PN2R2MC0□	2.2μH ±20%	1MHz	900mA	0.25Ω ±25%	50MHz	Kit

Class of Magnetic Shield: Magnetic shield of ferrite Operating Temperature Range: -55°C~+125°C

■ Inductance-Frequency Characteristics (Typ.)

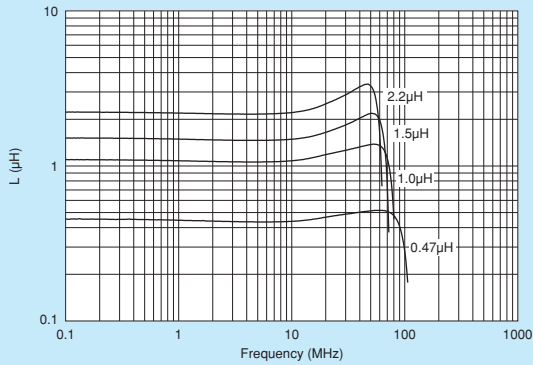

■ Inductance-Current Characteristics (Typ.)

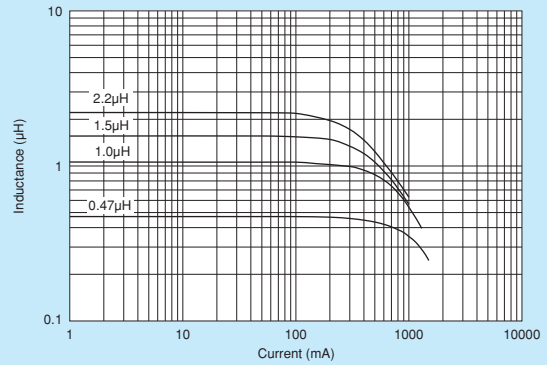

■ Temperature Rise Characteristics (Typ.)

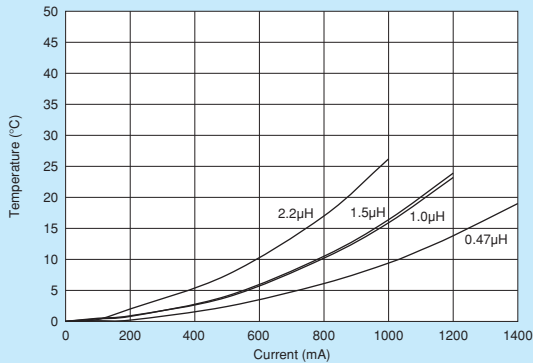

△Note • Please read rating and △CAUTION (for storage, operating, rating, soldering, mounting and handling) in this catalog to prevent smoking and/or burning, etc.
• This catalog has only typical specifications. Therefore, please approve our product specifications or transact the approval sheet for product specifications before ordering.

LQM32PN_G0 Series 1210/3225 (inch/mm)

Size Code 1210 (3225) in inch (in mm), 0.55mm max. Thickness

■ Appearance/Dimensions

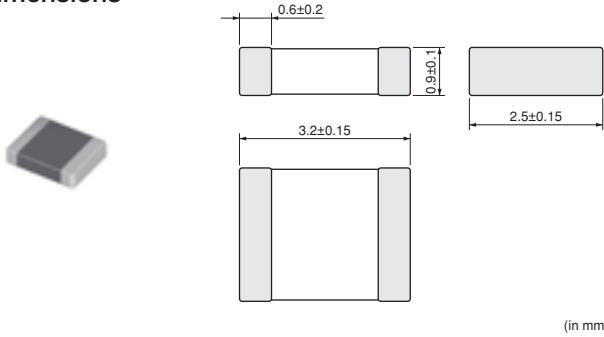

■ Packaging

Code	Packaging	Minimum Quantity
L	ø180mm Embossed Taping	3000
B	Packing in Bulk	1000



Refer to pages 102 to 106 for mounting information.

■ Rated Value (□: packaging code)

Part Number	Inductance	Inductance Test Frequency	Rated Current	DC Resistance	Self-Resonance Frequency (min.)	
LQM32PN1R0MG0□	1.0μH ±20%	1MHz	1800mA	0.048Ω ±25%	40MHz	Kit

Class of Magnetic Shield: Magnetic shield of ferrite Operating Temperature Range: -40°C~+85°C
For reflow soldering only.

■ Inductance-Frequency Characteristics (Typ.)

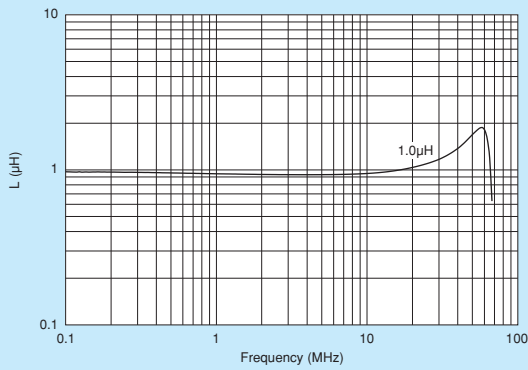

■ Inductance-Current Characteristics (Typ.)

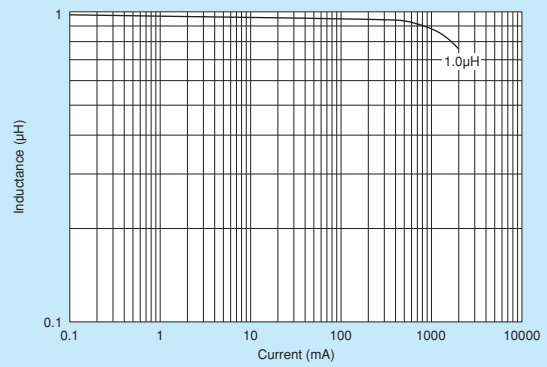

■ Temperature Rise Characteristics (Typ.)

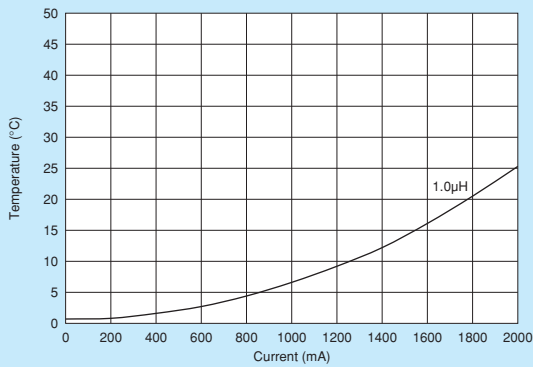

△Note • Please read rating and △CAUTION (for storage, operating, rating, soldering, mounting and handling) in this catalog to prevent smoking and/or burning, etc.
• This catalog has only typical specifications. Therefore, please approve our product specifications or transact the approval sheet for product specifications before ordering.

Wire Wound Type (Ferrite Core)

LQH2MCN_02 Series 0806/2016 (inch/mm)

Size Code 0806 (2016) in inch (in mm), 0.95mm max. Thickness

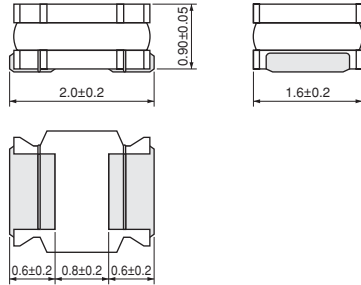
■ Appearance/
Dimensions

(in mm)

■ Packaging

Code	Packaging	Minimum Quantity
L	ø180mm Embossed Taping	3000
B	Packing in Bulk	100



Refer to pages 102 to 106 for mounting information.

■ Rated Value (□: packaging code)

Part Number	Inductance	Inductance Test Frequency	Rated Current ^{*1}	DC Resistance	Self-Resonance Frequency (min.)	
LQH2MCN1R0M02□	1.0μH ±20%	1MHz	485mA	0.30Ω ±30%	100MHz	Kit
LQH2MCN1R5M02□	1.5μH ±20%	1MHz	445mA	0.40Ω ±30%	95MHz	Kit
LQH2MCN2R2M02□	2.2μH ±20%	1MHz	425mA	0.48Ω ±30%	70MHz	Kit
LQH2MCN3R3M02□	3.3μH ±20%	1MHz	375mA	0.60Ω ±30%	65MHz	Kit
LQH2MCN4R7M02□	4.7μH ±20%	1MHz	300mA	0.8Ω ±30%	60MHz	Kit
LQH2MCN5R6M02□	5.6μH ±20%	1MHz	280mA	0.9Ω ±30%	60MHz	Kit
LQH2MCN6R8M02□	6.8μH ±20%	1MHz	255mA	1.0Ω ±30%	55MHz	Kit
LQH2MCN8R2M02□	8.2μH ±20%	1MHz	235mA	1.1Ω ±30%	50MHz	Kit
LQH2MCN100K02□	10μH ±10%	1MHz	225mA	1.2Ω ±30%	48MHz	Kit
LQH2MCN120K02□	12μH ±10%	1MHz	210mA	1.4Ω ±30%	44MHz	Kit
LQH2MCN150K02□	15μH ±10%	1MHz	200mA	1.6Ω ±30%	40MHz	Kit
LQH2MCN180K02□	18μH ±10%	1MHz	190mA	1.8Ω ±30%	35MHz	Kit
LQH2MCN220K02□	22μH ±10%	1MHz	185mA	2.1Ω ±30%	30MHz	Kit
LQH2MCN270K02□	27μH ±10%	1MHz	180mA	2.5Ω ±30%	30MHz	Kit
LQH2MCN330K02□	33μH ±10%	1MHz	160mA	2.8Ω ±30%	28MHz	Kit
LQH2MCN390K02□	39μH ±10%	1MHz	125mA	4.4Ω ±30%	24MHz	Kit
LQH2MCN470K02□	47μH ±10%	1MHz	120mA	5.1Ω ±30%	18MHz	Kit
LQH2MCN560K02□	56μH ±10%	1MHz	110mA	5.7Ω ±30%	17MHz	Kit
LQH2MCN680K02□	68μH ±10%	1MHz	100mA	6.6Ω ±30%	14MHz	Kit
LQH2MCN820K02□	82μH ±10%	1MHz	90mA	7.5Ω ±30%	14MHz	Kit

Class of Magnetic Shield: No magnetic shield

Operating Temperature Range (Self-temperature rise is not included): -40°C~+85°C

For reflow soldering only.

^{*1} When applied rated current to the products, self-temperature rise shall be limited to 40°C max. and inductance will be within ±10% of initial inductance value.

Continued on the following page. ↗

■ Inductance-Frequency Characteristics (Typ.)

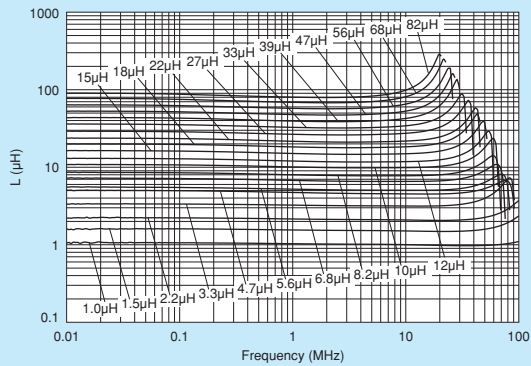

■ Inductance-Current Characteristics (Typ.)

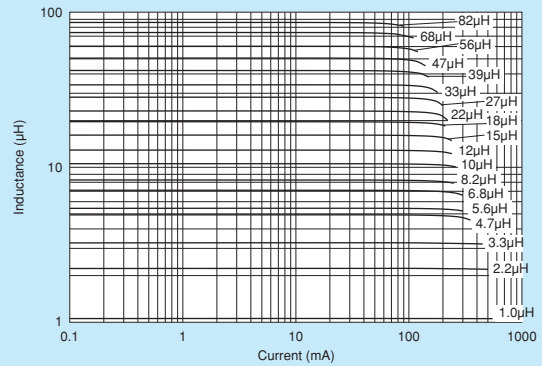

■ Temperature Rise Characteristics (Typ.)

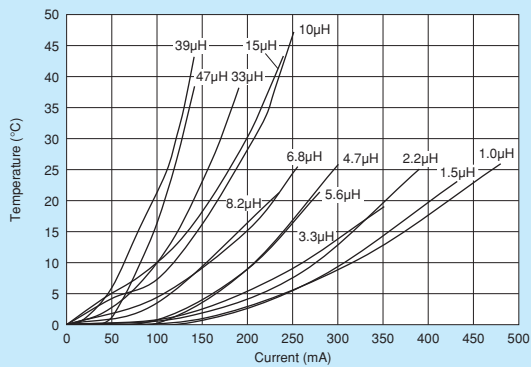

Wire Wound Type (Ferrite Core)
Inductors for Power Lines

Inductors for General Use

RF Inductors

⚠Note • Please read rating and ⚠CAUTION (for storage, operating, rating, soldering, mounting and handling) in this catalog to prevent smoking and/or burning, etc.
• This catalog has only typical specifications. Therefore, please approve our product specifications or transact the approval sheet for product specifications before ordering.

LQH2MCN_52 Series 0806/2016 (inch/mm)

Size Code 0806 (2016) in inch (in mm), 0.7mm max. Thickness

■ Appearance/Dimensions

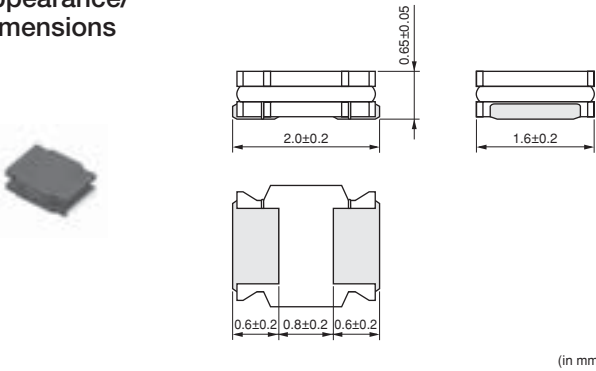

■ Packaging

Code	Packaging	Minimum Quantity
L	ø180mm Embossed Taping	3000
B	Packing in Bulk	100



Refer to pages 102 to 106 for mounting information.

■ Rated Value (□: packaging code)

Part Number	Inductance	Inductance Test Frequency	Rated Current ^{*1}	DC Resistance	Self-Resonance Frequency (min.)	
LQH2MCN1R0M52□	1.0μH ±20%	1MHz	595mA	0.25Ω ±30%	215MHz	Kit
LQH2MCN1R5M52□	1.5μH ±20%	1MHz	540mA	0.33Ω ±30%	165MHz	Kit
LQH2MCN2R2M52□	2.2μH ±20%	1MHz	500mA	0.42Ω ±30%	125MHz	Kit
LQH2MCN3R3M52□	3.3μH ±20%	1MHz	360mA	0.74Ω ±30%	110MHz	Kit
LQH2MCN4R7M52□	4.7μH ±20%	1MHz	335mA	0.91Ω ±30%	90MHz	Kit
LQH2MCN6R8M52□	6.8μH ±20%	1MHz	285mA	1.23Ω ±30%	65MHz	Kit
LQH2MCN100M52□	10μH ±20%	1MHz	200mA	2.27Ω ±30%	60MHz	Kit
LQH2MCN120M52□	12μH ±20%	1MHz	170mA	2.4Ω ±30%	30MHz	Kit
LQH2MCN150M52□	15μH ±20%	1MHz	150mA	3.5Ω ±30%	30MHz	Kit
LQH2MCN180M52□	18μH ±20%	1MHz	140mA	4.0Ω ±30%	30MHz	Kit
LQH2MCN220M52□	22μH ±20%	1MHz	130mA	5.5Ω ±30%	30MHz	Kit

Class of Magnetic Shield: No magnetic shield

Operating Temperature Range (Self-temperature rise is not included): -40°C~+85°C

For reflow soldering only.

*1 When applied rated current to the products, self-temperature rise shall be limited to 40°C max. and inductance will be within ±10% of initial inductance value.

■ Inductance-Frequency Characteristics (Typ.)

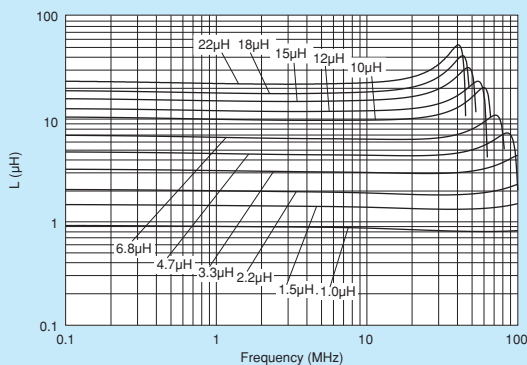

■ Inductance-Current Characteristics (Typ.)

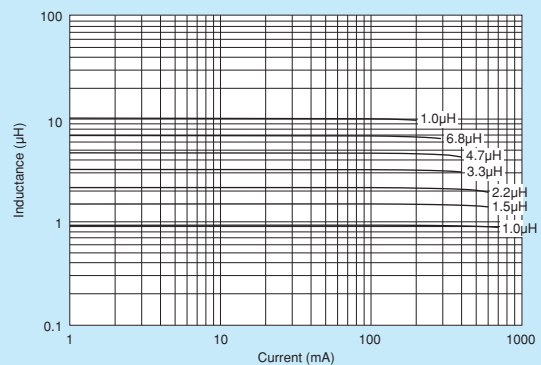

Continued on the following page.

△Note • Please read rating and △CAUTION (for storage, operating, rating, soldering, mounting and handling) in this catalog to prevent smoking and/or burning, etc.
• This catalog has only typical specifications. Therefore, please approve our product specifications or transact the approval sheet for product specifications before ordering.

■ Temperature Rise Characteristics (Typ.)

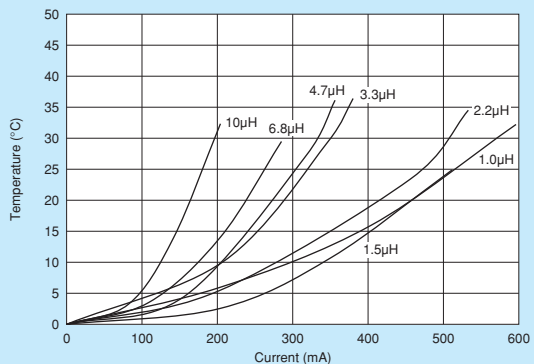

Wire Wound Type (Ferrite Core)
Inductors for Power Lines

Inductors for General Use

RF Inductors

⚠Note • Please read rating and ⚠CAUTION (for storage, operating, rating, soldering, mounting and handling) in this catalog to prevent smoking and/or burning, etc.
• This catalog has only typical specifications. Therefore, please approve our product specifications or transact the approval sheet for product specifications before ordering.

LQH2HPN_GO Series 1008/2520 (inch/mm)

Size Code 1008 (2520) in inch (in mm), 1.0mm max. Thickness

■ Appearance/Dimensions

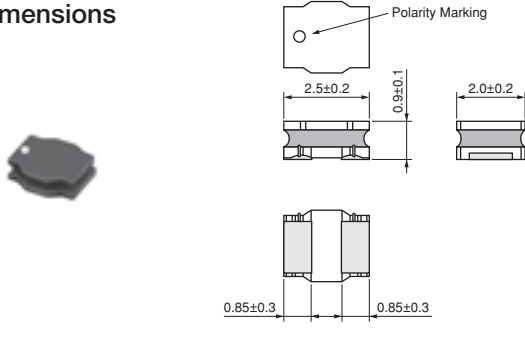

■ Packaging

Code	Packaging	Minimum Quantity
L	ø180mm Embossed Taping	3000



Refer to pages 102 to 106 for mounting information.

■ Rated Value (□: packaging code)

Part Number	Inductance	Rated Current ^{*1*3} (Based on Inductance Change)	Rated Current ^{*2*3} (Based on Temperature Rise)	DC Resistance	Self-Resonance Frequency (min.)	Kit
LQH2HPN2R2MG0□	2.2μH ±20%	1640mA	1000mA	0.17Ω ±20%	80MHz	Kit
LQH2HPN3R3MG0□	3.3μH ±20%	1290mA	810mA	0.27Ω ±20%	65MHz	Kit
LQH2HPN4R7MG0□	4.7μH ±20%	1000mA	700mA	0.36Ω ±20%	60MHz	Kit
LQH2HPN6R8MG0□	6.8μH ±20%	800mA	590mA	0.5Ω ±20%	10MHz	Kit
LQH2HPN100MG0□	10μH ±20%	700mA	490mA	0.73Ω ±20%	10MHz	Kit
LQH2HPN220MG0□	22μH ±20%	490mA	340mA	1.6Ω ±20%	10MHz	Kit
LQH2HPN101MG0□	100μH ±20%	210mA	130mA	10.0Ω ±20%	5MHz	Kit

Inductance Test Frequency: 1MHz Class of Magnetic Shield: Magnetic shield of magnetic powder in resin
 Operating Temperature Range (Self-temperature rise is not included): -40°C~+85°C
 For reflow soldering only.

*1 When applied rated current to the products, inductance will be within -30% of minimum rated inductance value.
 *2 When applied rated current to the products, self-temperature rise shall be limited to 40°C max.
 *3 Keep the temperature (ambient temperature plus self-generation of heat) under 125°C.

■ Inductance-Frequency Characteristics (Typ.)

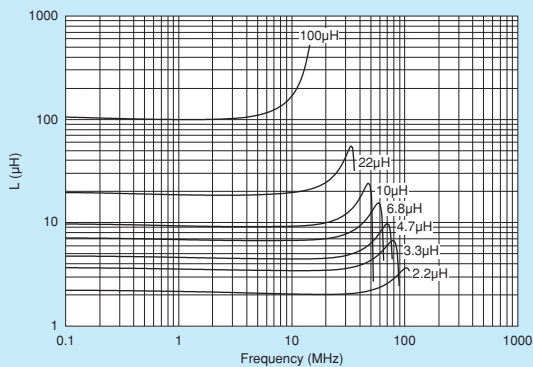

■ Inductance-Current Characteristics (Typ.)

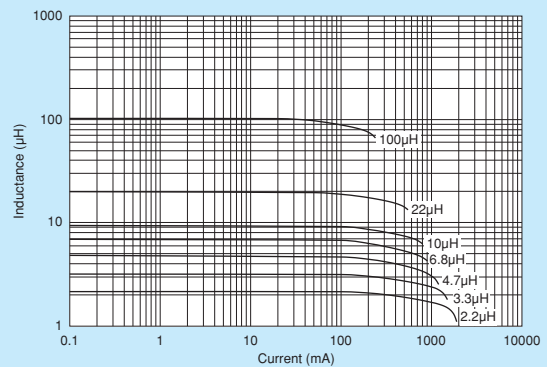

Continued on the following page.

△Note • Please read rating and △CAUTION (for storage, operating, rating, soldering, mounting and handling) in this catalog to prevent smoking and/or burning, etc.
 • This catalog has only typical specifications. Therefore, please approve our product specifications or transact the approval sheet for product specifications before ordering.

■ Temperature Rise Characteristics (Typ.)

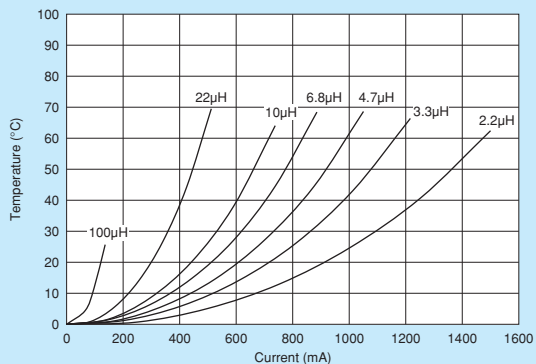

Wire Wound Type (Ferrite Core)
Inductors for Power Lines

Inductors for General Use

RF Inductors

⚠Note • Please read rating and ⚠CAUTION (for storage, operating, rating, soldering, mounting and handling) in this catalog to prevent smoking and/or burning, etc.
• This catalog has only typical specifications. Therefore, please approve our product specifications or transact the approval sheet for product specifications before ordering.

LQH2HPN_GR Series 1008/2520 (inch/mm)

Size Code 1008 (2520) in inch (in mm), 1.0mm max. Thickness. Low DC resistance design

■ Appearance/Dimensions

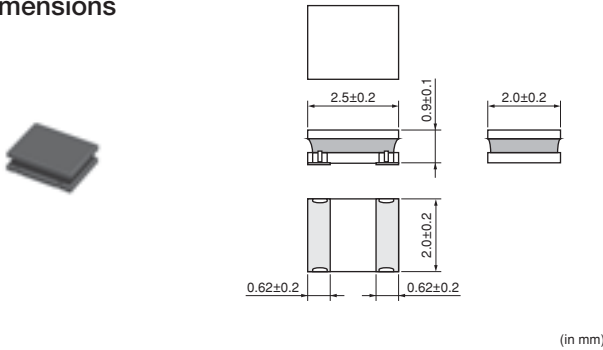

■ Packaging

Code	Packaging	Minimum Quantity
L	ø180mm Embossed Taping	3000



Refer to pages 102 to 106 for mounting information.

■ Rated Value (□: packaging code)

Part Number	Inductance	Rated Current ^{*1*3} (Based on Inductance Change)	Rated Current ^{*2*3} (Based on Temperature Rise)	DC Resistance	Self-Resonance Frequency (min.)	
LQH2HPNR47MGR□	0.47µH ±20%	2900mA	2520mA	0.045 Ω ±20%	120MHz	New
LQH2HPNR68MGR□	0.68µH ±20%	2430mA	2330mA	0.055 Ω ±20%	110MHz	New
LQH2HPN1R0MGR□	1.0µH ±20%	2130mA	2100mA	0.068 Ω ±20%	100MHz	New Kit
LQH2HPN1R5MGR□	1.5µH ±20%	1700mA	1850mA	0.087 Ω ±20%	90MHz	New
LQH2HPN2R2MGR□	2.2µH ±20%	1550mA	1470mA	0.134 Ω ±20%	80MHz	New Kit
LQH2HPN3R3MGR□	3.3µH ±20%	1230mA	1100mA	0.225 Ω ±20%	70MHz	New
LQH2HPN4R7MGR□	4.7µH ±20%	1090mA	1000mA	0.300 Ω ±20%	50MHz	New
LQH2HPN6R8MGR□	6.8µH ±20%	830mA	860mA	0.395 Ω ±20%	40MHz	New
LQH2HPN100MGR□	10µH ±20%	700mA	710mA	0.560 Ω ±20%	30MHz	New
LQH2HPN150MGR□	15µH ±20%	570mA	560mA	0.925 Ω ±20%	20MHz	New
LQH2HPN220MGR□	22µH ±20%	460mA	430mA	1.360 Ω ±20%	15MHz	New

Inductance Test Frequency: 1MHz Class of Magnetic Shield: Magnetic shield of magnetic powder in resin
 Operating Temperature Range (Self-temperature rise is not included): -40°C~+85°C
 For reflow soldering only.

*1 When applied rated current to the products, inductance will be within -30% of minimum rated inductance value.

*2 When applied rated current to the products, self-temperature rise shall be limited to 40°C max.

*3 Keep the temperature (ambient temperature plus self-generation of heat) under 125°C.

■ Inductance-Frequency Characteristics (Typ.)

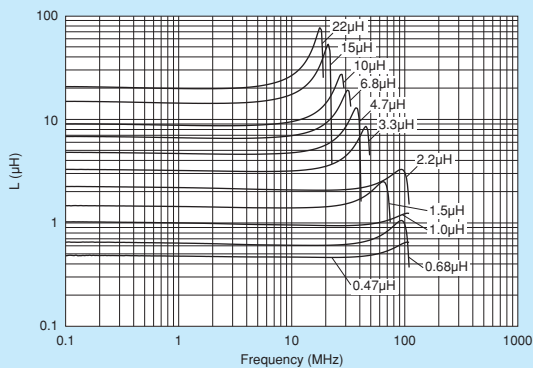

■ Inductance-Current Characteristics (Typ.)

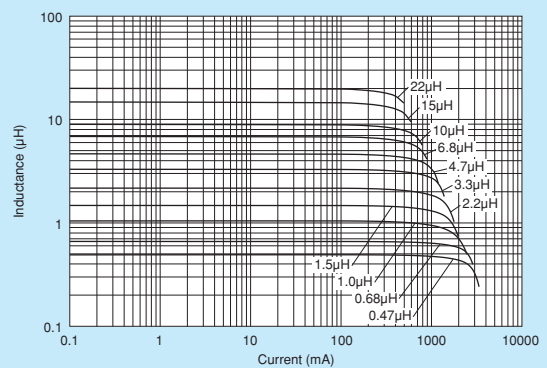

Continued on the following page.

△Note • Please read rating and △CAUTION (for storage, operating, rating, soldering, mounting and handling) in this catalog to prevent smoking and/or burning, etc.
 • This catalog has only typical specifications. Therefore, please approve our product specifications or transact the approval sheet for product specifications before ordering.

Temperature Rise Characteristics (Typ.)

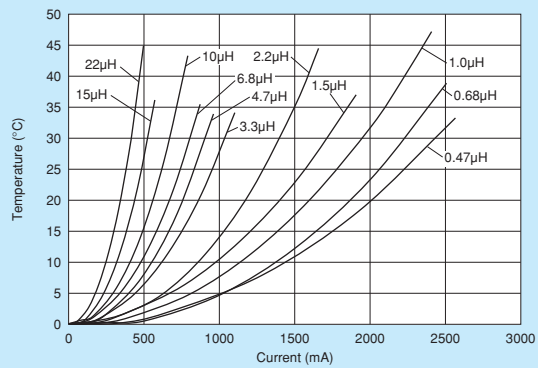

LQH2HPN_J0 Series 1008/2520 (inch/mm)

Size Code 1008 (2520) in inch (in mm), 1.2mm max. Thickness

■ Appearance/Dimensions

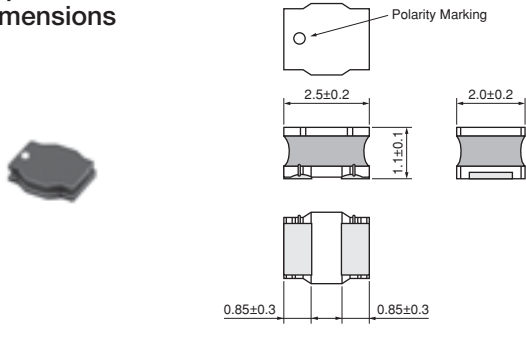

■ Packaging

Code	Packaging	Minimum Quantity
L	ø180mm Embossed Taping	2000



Refer to pages 102 to 106 for mounting information.

■ Rated Value (□: packaging code)

Part Number	Inductance	Rated Current ^{*1*3} (Based on Inductance Change)	Rated Current ^{*2*3} (Based on Temperature Rise)	DC Resistance	Self-Resonance Frequency (min.)	Kit
LQH2HPN1R5NJ0□	1.5μH ±30%	2400mA	1500mA	0.096 Ω ±20%	10MHz	Kit
LQH2HPN2R2MJ0□	2.2μH ±20%	1800mA	1300mA	0.132 Ω ±20%	10MHz	Kit
LQH2HPN3R3MJ0□	3.3μH ±20%	1500mA	950mA	0.230 Ω ±20%	10MHz	Kit
LQH2HPN4R7MJ0□	4.7μH ±20%	1250mA	700mA	0.330 Ω ±20%	10MHz	Kit
LQH2HPN6R8MJ0□	6.8μH ±20%	1100mA	600mA	0.448 Ω ±20%	10MHz	Kit
LQH2HPN100MJ0□	10μH ±20%	820mA	550mA	0.641 Ω ±20%	10MHz	Kit

Inductance Test Frequency: 1MHz Class of Magnetic Shield: Magnetic shield of magnetic powder in resin

Operating Temperature Range (Self-temperature rise is not included): -40°C~+85°C

For reflow soldering only.

*1 When applied rated current to the products, inductance will be within -30% of minimum rated inductance value.

*2 When applied rated current to the products, self-temperature rise shall be limited to 40°C max.

*3 Keep the temperature (ambient temperature plus self-generation of heat) under 125°C.

■ Inductance-Frequency Characteristics (Typ.)

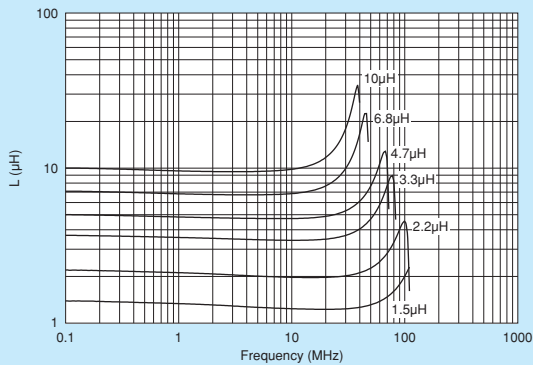

■ Inductance-Current Characteristics (Typ.)

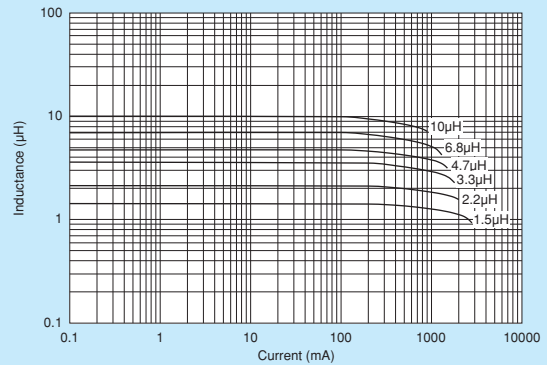

Continued on the following page.

△Note • Please read rating and △CAUTION (for storage, operating, rating, soldering, mounting and handling) in this catalog to prevent smoking and/or burning, etc.
• This catalog has only typical specifications. Therefore, please approve our product specifications or transact the approval sheet for product specifications before ordering.

Temperature Rise Characteristics (Typ.)

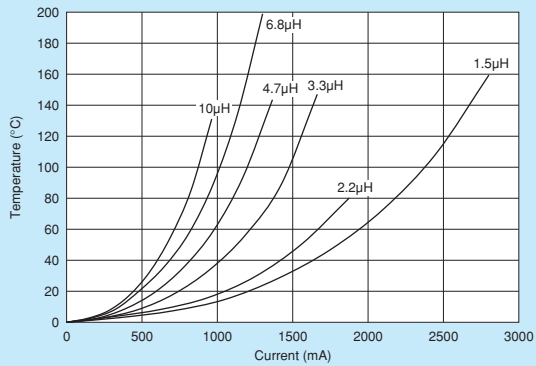

LQH2HPN_M0 Series 1008/2520 (inch/mm)

Size Code 1008 (2520) in inch (in mm), 1.5mm max. Thickness

■ Appearance/Dimensions

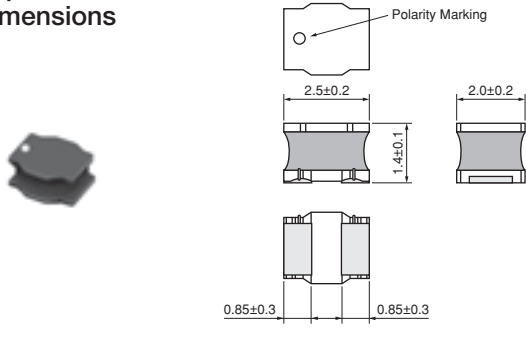

■ Packaging

Code	Packaging	Minimum Quantity
L	ø180mm Embossed Taping	2000



Refer to pages 102 to 106 for mounting information.

■ Rated Value (□: packaging code)

Part Number	Inductance	Rated Current ^{*1*3} (Based on Inductance Change)	Rated Current ^{*2*3} (Based on Temperature Rise)	DC Resistance	Self-Resonance Frequency (min.)	Kit
LQH2HPN2R2MM0□	2.2μH ±20%	1700mA	1250mA	0.146Ω ±20%	10MHz	Kit
LQH2HPN4R7NM0□	4.7μH ±30%	1200mA	800mA	0.342Ω ±20%	10MHz	Kit

Inductance Test Frequency: 1MHz Class of Magnetic Shield: Magnetic shield of magnetic powder in resin
 Operating Temperature Range (Self-temperature rise is not included): -40°C~+85°C

For reflow soldering only.

*1 When applied rated current to the products, inductance will be within ±30% of initial inductance value.

*2 When applied rated current to the products, self-temperature rise shall be limited to 40°C max.

*3 Keep the temperature (ambient temperature plus self-generation of heat) under 125°C.

■ Inductance-Frequency Characteristics (Typ.)

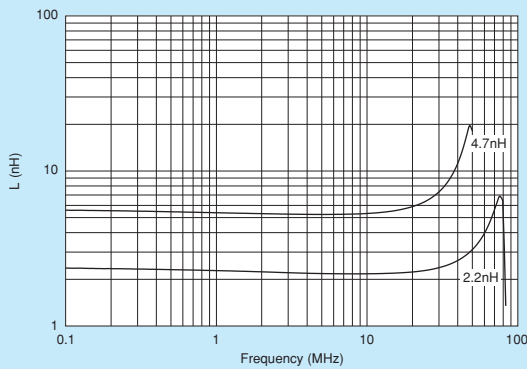

■ Inductance-Current Characteristics (Typ.)

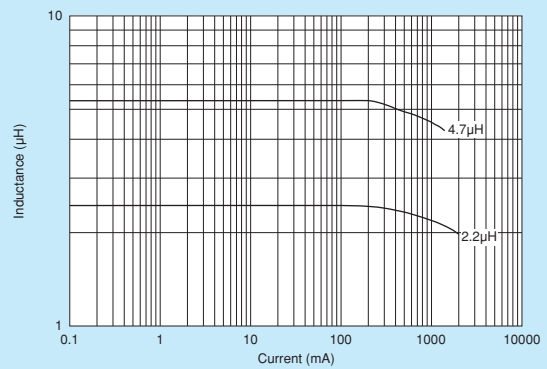

■ Temperature Rise Characteristics (Typ.)

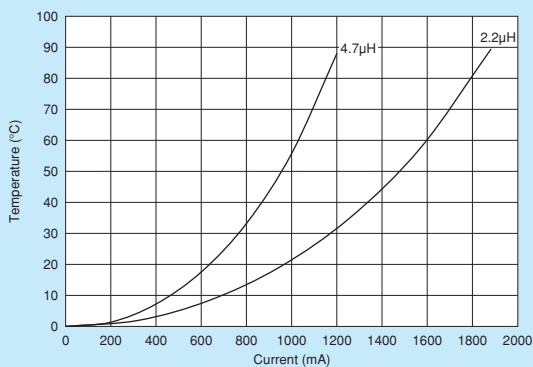

△Note • Please read rating and △CAUTION (for storage, operating, rating, soldering, mounting and handling) in this catalog to prevent smoking and/or burning, etc.
 • This catalog has only typical specifications. Therefore, please approve our product specifications or transact the approval sheet for product specifications before ordering.

LQH3NPN_M0 Series 1212/3030 (inch/mm)

Size Code 1212 (3030) in inch (in mm), 1.5mm max. Thickness

■ Appearance/ Dimensions

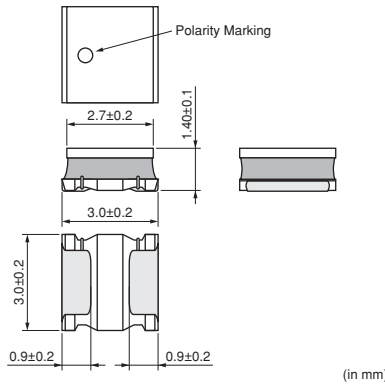

■ Packaging

Code	Packaging	Minimum Quantity
L	ø180mm Embossed Taping	1000
K	ø330mm Embossed Taping	4000



Refer to pages 102 to 106 for mounting information.

■ Rated Value (□: packaging code)

Part Number	Inductance	Rated Current ^{*1*3} (Based on Inductance Change)	Rated Current ^{*2*3} (Based on Temperature Rise)	DC Resistance	Self-Resonance Frequency (min.)	Kit
LQH3NPN1R0MM0□	1.0μH ±20%	1400mA	2050mA	0.044Ω ±20%	130MHz	Kit
LQH3NPN1R0NM0□	1.0μH ±30%	1400mA	2050mA	0.044Ω ±20%	130MHz	
LQH3NPN2R2MM0□	2.2μH ±20%	1250mA	1600mA	0.073Ω ±20%	90MHz	Kit
LQH3NPN2R2NM0□	2.2μH ±30%	1250mA	1600mA	0.073Ω ±20%	90MHz	
LQH3NPN3R3MM0□	3.3μH ±20%	1000mA	1450mA	0.092Ω ±20%	75MHz	Kit
LQH3NPN3R3NM0□	3.3μH ±30%	1000mA	1450mA	0.092Ω ±20%	75MHz	
LQH3NPN4R7MM0□	4.7μH ±20%	880mA	1250mA	0.13Ω ±20%	65MHz	Kit
LQH3NPN4R7NM0□	4.7μH ±30%	880mA	1250mA	0.13Ω ±20%	65MHz	
LQH3NPN6R8MM0□	6.8μH ±20%	820mA	1000mA	0.20Ω ±20%	50MHz	Kit
LQH3NPN6R8NM0□	6.8μH ±30%	820mA	1000mA	0.20Ω ±20%	50MHz	
LQH3NPN100MM0□	10μH ±20%	550mA	870mA	0.26Ω ±20%	45MHz	Kit
LQH3NPN100NM0□	10μH ±30%	550mA	870mA	0.26Ω ±20%	45MHz	
LQH3NPN150MM0□	15μH ±20%	520mA	730mA	0.36Ω ±20%	30MHz	Kit
LQH3NPN150NM0□	15μH ±30%	520mA	730mA	0.36Ω ±20%	30MHz	
LQH3NPN220MM0□	22μH ±20%	410mA	650mA	0.51Ω ±20%	28MHz	Kit
LQH3NPN330MM0□	33μH ±20%	370mA	500mA	0.85Ω ±20%	22MHz	Kit
LQH3NPN470MM0□	47μH ±20%	310mA	410mA	1.25Ω ±20%	18MHz	Kit
LQH3NPN101MM0□	100μH ±20%	200mA	240mA	3.50Ω ±20%	12MHz	Kit

Inductance Test Frequency: 1MHz Class of Magnetic Shield: Magnetic shield of magnetic powder in resin

Operating Temperature Range (Self-temperature rise is included): -40°C~+125°C

Operating Temperature Range (Self-temperature rise is not included): -40°C~+85°C

For reflow soldering only.

*1 When applied rated current to the products, inductance will be within ±30% of initial inductance value.

*2 When applied rated current to the products, self-temperature rise shall be limited to 40°C max.

*3 Keep the temperature (ambient temperature plus self-generation of heat) under 125°C.

Continued on the following page. ↗

△Note • Please read rating and △CAUTION (for storage, operating, rating, soldering, mounting and handling) in this catalog to prevent smoking and/or burning, etc.
• This catalog has only typical specifications. Therefore, please approve our product specifications or transact the approval sheet for product specifications before ordering.

■ Inductance-Frequency Characteristics (Typ.)

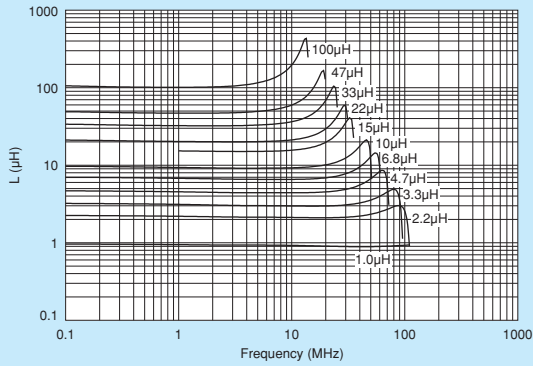

■ Inductance-Current Characteristics (Typ.)

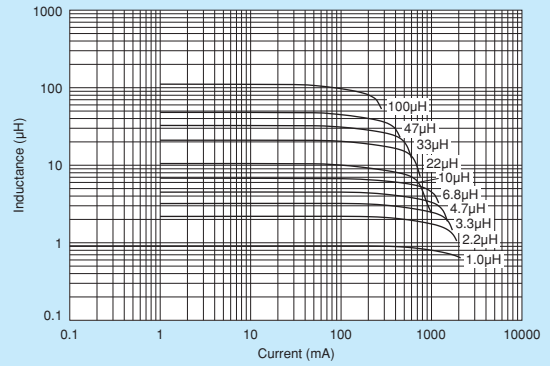

■ Temperature Rise Characteristics (Typ.)

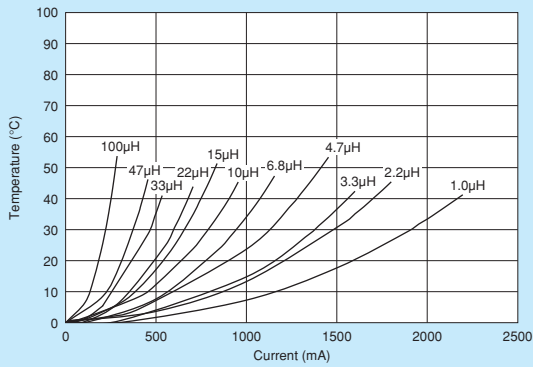

⚠Note • Please read rating and ⚠CAUTION (for storage, operating, rating, soldering, mounting and handling) in this catalog to prevent smoking and/or burning, etc.
• This catalog has only typical specifications. Therefore, please approve our product specifications or transact the approval sheet for product specifications before ordering.

LQH3NPN_MR Series 1212/3030 (inch/mm)

Low DC Resistance Type

Appearance/Dimensions

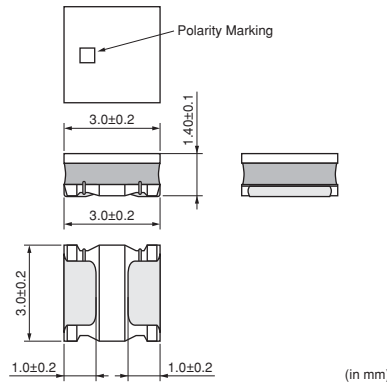

Packaging

Code	Packaging	Minimum Quantity
E	ø180mm Embossed Taping	2000
F	ø330mm Embossed Taping	8000



Refer to pages 102 to 106 for mounting information.

Rated Value (□: packaging code)

Part Number	Inductance	Rated Current ^{*1*3} (Based on Inductance Change)	Rated Current ^{*2*3} (Based on Temperature Rise)	DC Resistance	Self-Resonance Frequency (min.)	Kit
LQH3NPN1R0MMR□	1.0μH ±20%	1600mA	2150mA	0.042Ω ±20%	135MHz	Kit
LQH3NPN2R2MMR□	2.2μH ±20%	1380mA	1750mA	0.068Ω ±20%	75MHz	Kit
LQH3NPN3R3MMR□	3.3μH ±20%	1200mA	1550mA	0.088Ω ±20%	70MHz	Kit
LQH3NPN4R7MMR□	4.7μH ±20%	950mA	1400mA	0.105Ω ±20%	57MHz	Kit
LQH3NPN6R8MMR□	6.8μH ±20%	830mA	1250mA	0.155Ω ±20%	40MHz	Kit
LQH3NPN100MMR□	10μH ±20%	590mA	1150mA	0.210Ω ±20%	30MHz	Kit
LQH3NPN220MMR□	22μH ±20%	430mA	750mA	0.480Ω ±20%	20MHz	Kit
LQH3NPN330MMR□	33μH ±20%	380mA	600mA	0.790Ω ±20%	15MHz	Kit
LQH3NPN470MMR□	47μH ±20%	320mA	460mA	1.140Ω ±20%	10MHz	Kit

Inductance Test Frequency: 1MHz Class of Magnetic Shield: Magnetic shield of magnetic powder in resin

Operating Temperature Range (Self-temperature rise is included): -40°C~+125°C

Operating Temperature Range (Self-temperature rise is not included): -40°C~+85°C

For reflow soldering only.

*1 When applied rated current to the products, inductance will be within ±30% of initial inductance value.

*2 When applied rated current to the products, self-temperature rise shall be limited to 40°C max.

*3 Keep the temperature (ambient temperature plus self-generation of heat) under 125°C.

Inductance-Frequency Characteristics (Typ.)

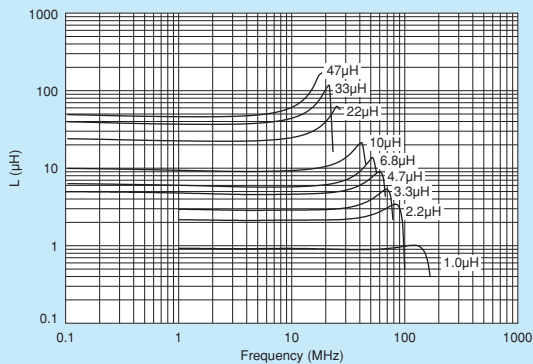

Inductance-Current Characteristics (Typ.)

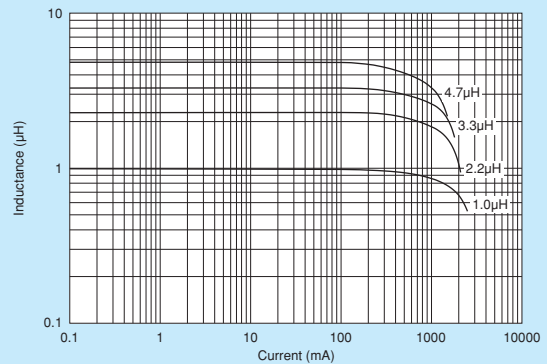

Continued on the following page.

Note • Please read rating and CAUTION (for storage, operating, rating, soldering, mounting and handling) in this catalog to prevent smoking and/or burning, etc.
• This catalog has only typical specifications. Therefore, please approve our product specifications or transact the approval sheet for product specifications before ordering.

Temperature Rise Characteristics (Typ.)

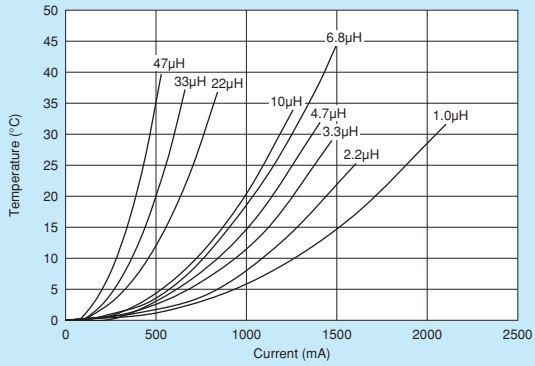

⚠Note • Please read rating and ⚠CAUTION (for storage, operating, rating, soldering, mounting and handling) in this catalog to prevent smoking and/or burning, etc.
• This catalog has only typical specifications. Therefore, please approve our product specifications or transact the approval sheet for product specifications before ordering.

Wire Wound Type (Ferrite Core)

LQH3NPN_J0 Series 1212/3030 (inch/mm)

Size Code 1212 (3030) in inch (in mm), 1.2mm max. Thickness

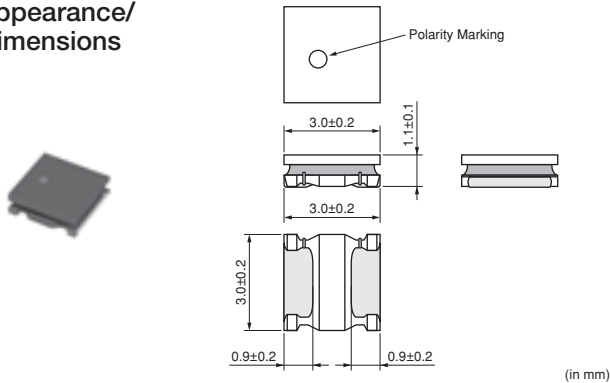
■ Appearance/
Dimensions

■ Packaging

Code	Packaging	Minimum Quantity
L	ø180mm Embossed Taping	1000
K	ø330mm Embossed Taping	5000



Refer to pages 102 to 106 for mounting information.

■ Rated Value (□: packaging code)

Part Number	Inductance	Rated Current ^{*1*3} (Based on Inductance Change)	Rated Current ^{*2*3} (Based on Temperature Rise)	DC Resistance	Self-Resonance Frequency (min.)	
LQH3NPN1R0NJ0□	1.0μH ±30%	1650mA	1620mA	0.040 Ω ±20%	140MHz	Kit
LQH3NPN1R5NJ0□	1.5μH ±30%	1200mA	1500mA	0.055 Ω ±20%	90MHz	Kit
LQH3NPN2R2MJ0□	2.2μH ±20%	1150mA	1460mA	0.069 Ω ±20%	90MHz	Kit
LQH3NPN2R2NJ0□	2.2μH ±30%	1150mA	1460mA	0.069 Ω ±20%	90MHz	
LQH3NPN3R3MJ0□	3.3μH ±20%	950mA	1270mA	0.105 Ω ±20%	70MHz	Kit
LQH3NPN3R3NJ0□	3.3μH ±30%	950mA	1270mA	0.105 Ω ±20%	70MHz	
LQH3NPN4R7MJ0□	4.7μH ±20%	780mA	1120mA	0.130 Ω ±20%	65MHz	Kit
LQH3NPN4R7NJ0□	4.7μH ±30%	780mA	1120mA	0.130 Ω ±20%	65MHz	
LQH3NPN6R8MJ0□	6.8μH ±20%	700mA	850mA	0.210 Ω ±20%	45MHz	Kit
LQH3NPN6R8NJ0□	6.8μH ±30%	700mA	850mA	0.210 Ω ±20%	45MHz	
LQH3NPN100MJ0□	10μH ±20%	560mA	710mA	0.300 Ω ±20%	35MHz	Kit
LQH3NPN100NJ0□	10μH ±30%	560mA	710mA	0.300 Ω ±20%	35MHz	
LQH3NPN150MJ0□	15μH ±20%	440mA	590mA	0.440 Ω ±20%	30MHz	Kit
LQH3NPN150NJ0□	15μH ±30%	440mA	590mA	0.440 Ω ±20%	30MHz	
LQH3NPN220MJ0□	22μH ±20%	350mA	510mA	0.600 Ω ±20%	25MHz	Kit
LQH3NPN220NJ0□	22μH ±30%	350mA	510mA	0.600 Ω ±20%	25MHz	
LQH3NPN330MJ0□	33μH ±20%	280mA	410mA	0.900 Ω ±20%	20MHz	Kit
LQH3NPN330NJ0□	33μH ±30%	280mA	410mA	0.900 Ω ±20%	20MHz	
LQH3NPN470MJ0□	47μH ±20%	200mA	350mA	1.30 Ω ±20%	15MHz	Kit
LQH3NPN470NJ0□	47μH ±30%	200mA	350mA	1.30 Ω ±20%	15MHz	

Inductance Test Frequency: 1MHz Class of Magnetic Shield: Magnetic shield of magnetic powder in resin

Operating Temperature Range (Self-temperature rise is included): -40°C~+125°C

Operating Temperature Range (Self-temperature rise is not included): -40°C~+85°C

For reflow soldering only.

*1 When applied rated current to the products, inductance will be within ±30% of initial inductance value.

*2 When applied rated current to the products, self-temperature rise shall be limited to 40°C max.

*3 Keep the temperature (ambient temperature plus self-generation of heat) under 125°C.

Continued on the following page. ↗

■ Inductance-Frequency Characteristics (Typ.)

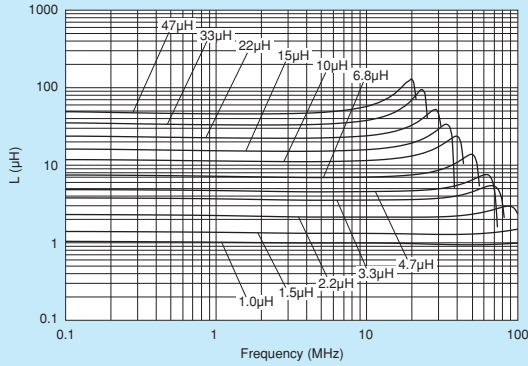

■ Inductance-Current Characteristics (Typ.)

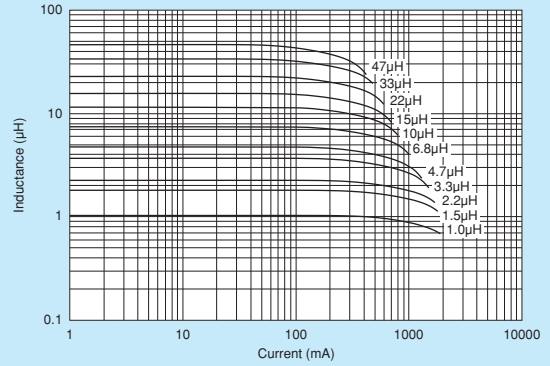

■ Temperature Rise Characteristics (Typ.)

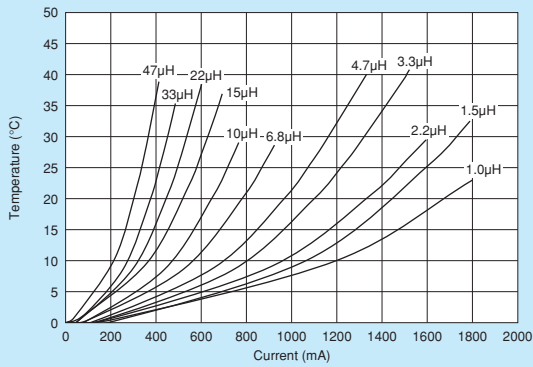

⚠Note • Please read rating and ⚠CAUTION (for storage, operating, rating, soldering, mounting and handling) in this catalog to prevent smoking and/or burning, etc.
• This catalog has only typical specifications. Therefore, please approve our product specifications or transact the approval sheet for product specifications before ordering.

LQH3NPN_GO Series 1212/3030 (inch/mm)

Size Code 1212 (3030) in inch (in mm), 1.0mm max. Thickness

■ Appearance/ Dimensions

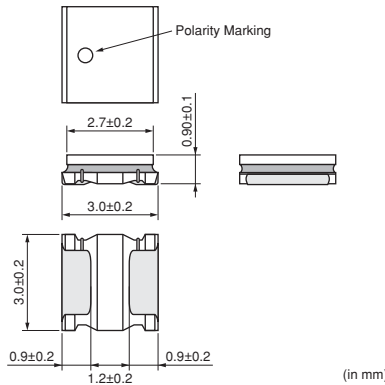

■ Packaging

Code	Packaging	Minimum Quantity
L	ø180mm Embossed Taping	1500
K	ø330mm Embossed Taping	6000



Refer to pages 102 to 106 for mounting information.

■ Rated Value (□: packaging code)

Part Number	Inductance	Rated Current ^{*1*3} (Based on Inductance Change)	Rated Current ^{*2*3} (Based on Temperature Rise)	DC Resistance	Self-Resonance Frequency (min.)	
LQH3NPN1R0NG0□	1.0μH ±30%	1650mA	1525mA	0.08Ω ±20%	160MHz	Kit
LQH3NPN1R5NG0□	1.5μH ±30%	1300mA	1470mA	0.10Ω ±20%	130MHz	Kit
LQH3NPN2R2NG0□	2.2μH ±30%	1250mA	1270mA	0.14Ω ±20%	100MHz	Kit
LQH3NPN3R3NG0□	3.3μH ±30%	850mA	1130mA	0.18Ω ±20%	75MHz	Kit
LQH3NPN4R7NG0□	4.7μH ±30%	800mA	925mA	0.26Ω ±20%	60MHz	Kit
LQH3NPN6R8NG0□	6.8μH ±30%	650mA	710mA	0.45Ω ±20%	48MHz	Kit
LQH3NPN100MG0□	10μH ±20%	500mA	630mA	0.57Ω ±20%	45MHz	Kit
LQH3NPN100NG0□	10μH ±30%	500mA	630mA	0.57Ω ±20%	45MHz	
LQH3NPN150NG0□	15μH ±30%	370mA	475mA	0.91Ω ±20%	35MHz	Kit
LQH3NPN220MG0□	22μH ±20%	340mA	430mA	1.1Ω ±20%	25MHz	Kit
LQH3NPN220NG0□	22μH ±30%	340mA	430mA	1.1Ω ±20%	25MHz	
LQH3NPN330MG0□	33μH ±20%	250mA	345mA	2.1Ω ±20%	24MHz	Kit
LQH3NPN330NG0□	33μH ±30%	250mA	345mA	2.1Ω ±20%	24MHz	
LQH3NPN470MG0□	47μH ±20%	170mA	270mA	3.0Ω ±20%	19MHz	Kit
LQH3NPN470NG0□	47μH ±30%	170mA	270mA	3.0Ω ±20%	19MHz	
LQH3NPN680MG0□	68μH ±20%	150mA	235mA	4.2Ω ±20%	16MHz	Kit
LQH3NPN680NG0□	68μH ±30%	150mA	235mA	4.2Ω ±20%	16MHz	
LQH3NPN101MG0□	100μH ±20%	140mA	165mA	8.0Ω ±20%	10MHz	Kit
LQH3NPN101NG0□	100μH ±30%	140mA	165mA	8.0Ω ±20%	10MHz	
LQH3NPN151MG0□	150μH ±20%	110mA	145mA	11.0Ω ±20%	10MHz	Kit
LQH3NPN151NG0□	150μH ±30%	110mA	145mA	11.0Ω ±20%	10MHz	
LQH3NPN221MG0□	220μH ±20%	100mA	130mA	14.0Ω ±20%	8.5MHz	Kit
LQH3NPN221NG0□	220μH ±30%	100mA	130mA	14.0Ω ±20%	8.5MHz	
LQH3NPN251MG0□	250μH ±20%	80mA	130mA	15.0Ω ±20%	8.0MHz	Kit
LQH3NPN251NG0□	250μH ±30%	80mA	130mA	15.0Ω ±20%	8.0MHz	

Inductance Test Frequency: 1MHz Class of Magnetic Shield: Magnetic shield of magnetic powder in resin
 Operating Temperature Range (Self-temperature rise is not included): -40°C~+85°C

For reflow soldering only.

*1 When applied rated current to the products, inductance will be within ±30% of initial inductance value.

*2 When applied rated current to the products, self-temperature rise shall be limited to 40°C max.

*3 Keep the temperature (ambient temperature plus self-generation of heat) under 125°C.

Continued on the following page.

△Note • Please read rating and △CAUTION (for storage, operating, rating, soldering, mounting and handling) in this catalog to prevent smoking and/or burning, etc.
 • This catalog has only typical specifications. Therefore, please approve our product specifications or transact the approval sheet for product specifications before ordering.

■ Inductance-Frequency Characteristics (Typ.)

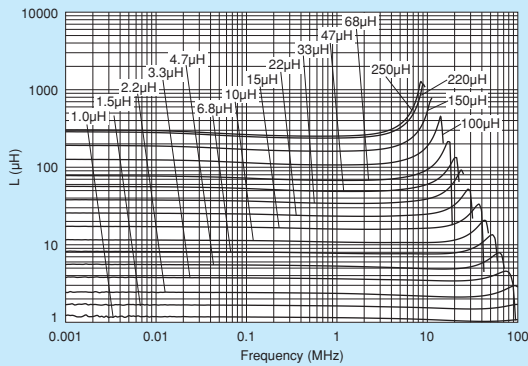

■ Inductance-Current Characteristics (Typ.)

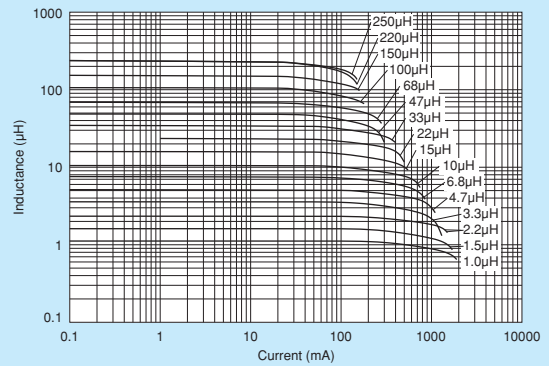

■ Temperature Rise Characteristics (Typ.)

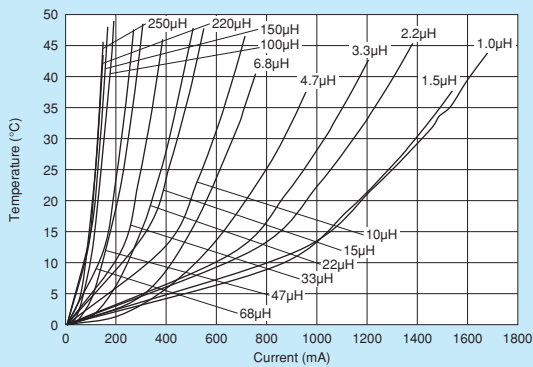

⚠Note • Please read rating and ⚠CAUTION (for storage, operating, rating, soldering, mounting and handling) in this catalog to prevent smoking and/or burning, etc.
• This catalog has only typical specifications. Therefore, please approve our product specifications or transact the approval sheet for product specifications before ordering.

LQH32PN_N0 Series 1210/3225 (inch/mm)

Size Code 1210 (3225) in inch (in mm), 1.7mm max. Thickness

■ Appearance/ Dimensions

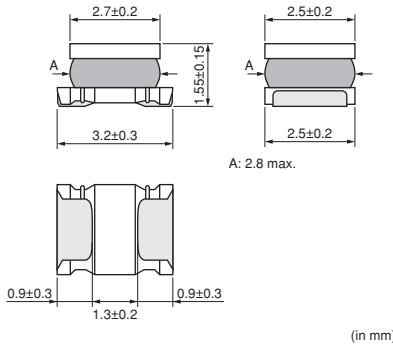

■ Packaging

Code	Packaging	Minimum Quantity
L	ø180mm Embossed Taping	2000
K	ø330mm Embossed Taping	7500



Refer to pages 102 to 106 for mounting information.

■ Rated Value (□: packaging code)

Part Number	Inductance	Rated Current ^{*1*3} (Based on Inductance Change)	Rated Current ^{*2*3} (Based on Temperature Rise)	DC Resistance	Self-Resonance Frequency (min.)	Kit
LQH32PNR47NN0□	0.47μH ±30%	3400mA	2550mA	0.03Ω ±20%	100MHz	Kit
LQH32PN1R0NN0□	1.0μH ±30%	2300mA	2050mA	0.045Ω ±20%	100MHz	Kit
LQH32PN1R5NN0□	1.5μH ±30%	1750mA	1750mA	0.057Ω ±20%	70MHz	Kit
LQH32PN2R2NN0□	2.2μH ±30%	1550mA	1600mA	0.076Ω ±20%	70MHz	Kit
LQH32PN3R3NN0□	3.3μH ±30%	1250mA	1200mA	0.12Ω ±20%	50MHz	Kit
LQH32PN4R7NN0□	4.7μH ±30%	1000mA	1000mA	0.18Ω ±20%	40MHz	Kit
LQH32PN6R8NN0□	6.8μH ±30%	850mA	850mA	0.24Ω ±20%	40MHz	Kit
LQH32PN100MN0□	10μH ±20%	750mA	700mA	0.38Ω ±20%	30MHz	Kit
LQH32PN150MN0□	15μH ±20%	600mA	520mA	0.57Ω ±20%	20MHz	Kit
LQH32PN220MN0□	22μH ±20%	500mA	450mA	0.81Ω ±20%	20MHz	Kit
LQH32PN330MN0□	33μH ±20%	380mA	390mA	1.15Ω ±20%	13MHz	Kit
LQH32PN470MN0□	47μH ±20%	330mA	310mA	1.78Ω ±20%	11MHz	Kit
LQH32PN680MN0□	68μH ±20%	280mA	275mA	2.28Ω ±20%	11MHz	Kit
LQH32PN101MN0□	100μH ±20%	180mA	250mA	2.70Ω ±20%	8MHz	Kit
LQH32PN121MN0□	120μH ±20%	170mA	200mA	4.38Ω ±20%	8MHz	Kit

Inductance Test Frequency: 1MHz Class of Magnetic Shield: Magnetic shield of magnetic powder in resin
 Operating Temperature Range (Self-temperature rise is included): -40°C~+125°C
 Operating Temperature Range (Self-temperature rise is not included): -40°C~+85°C
 For reflow soldering only.

*1 When applied rated current to the products, inductance will be within ±30% of initial inductance value.

*2 When applied rated current to the products, self-temperature rise shall be limited to 40°C max.

*3 Keep the temperature (ambient temperature plus self-generation of heat) under 125°C.

Continued on the following page.

△Note • Please read rating and △CAUTION (for storage, operating, rating, soldering, mounting and handling) in this catalog to prevent smoking and/or burning, etc.
 • This catalog has only typical specifications. Therefore, please approve our product specifications or transact the approval sheet for product specifications before ordering.

■ Inductance-Frequency Characteristics (Typ.)

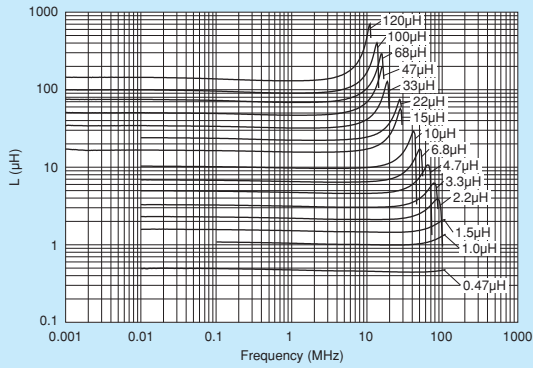

■ Inductance-Current Characteristics (Typ.)

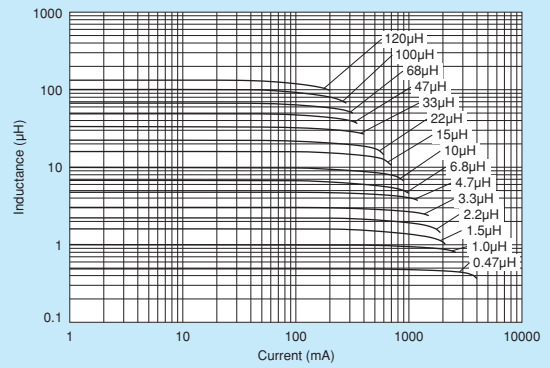

■ Temperature Rise Characteristics (Typ.)

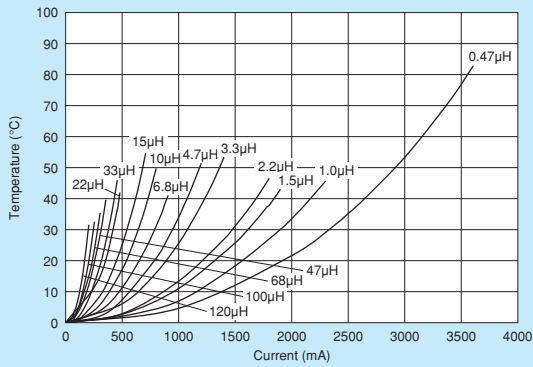

△Note • Please read rating and △CAUTION (for storage, operating, rating, soldering, mounting and handling) in this catalog to prevent smoking and/or burning, etc.
• This catalog has only typical specifications. Therefore, please approve our product specifications or transact the approval sheet for product specifications before ordering.

LQH32PN_NC Series 1210/3225 (inch/mm)

Bias Current Characteristics Improved

Appearance/Dimensions

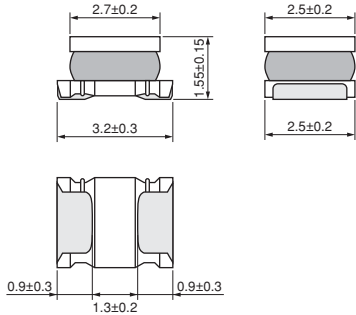

(in mm)

Packaging

Code	Packaging	Minimum Quantity
L	ø180mm Embossed Taping	2000
K	ø330mm Embossed Taping	7500



Refer to pages 102 to 106 for mounting information.

Rated Value (□: packaging code)

Part Number	Inductance	Rated Current ^{*1*3} (Based on Inductance Change)	Rated Current ^{*2*3} (Based on Temperature Rise)	DC Resistance	Self-Resonance Frequency (min.)	
LQH32PNR47NNC□	0.47μH ±30%	4400mA	2900mA	0.024Ω ±20%	100MHz	Kit
LQH32PN1R0NNC□	1.0μH ±30%	3000mA	2500mA	0.036Ω ±20%	100MHz	Kit
LQH32PN1R5NNC□	1.5μH ±30%	2600mA	2100mA	0.053Ω ±20%	70MHz	Kit
LQH32PN2R2NNC□	2.2μH ±30%	2000mA	1850mA	0.064Ω ±20%	70MHz	Kit
LQH32PN3R3NNC□	3.3μH ±30%	1900mA	1550mA	0.100Ω ±20%	50MHz	Kit
LQH32PN4R7NNC□	4.7μH ±30%	1600mA	1200mA	0.155Ω ±20%	40MHz	Kit
LQH32PN6R8NNC□	6.8μH ±30%	1300mA	1100mA	0.220Ω ±20%	40MHz	Kit
LQH32PN100MNC□	10μH ±20%	1000mA	900mA	0.295Ω ±20%	30MHz	Kit
LQH32PN150MNC□	15μH ±20%	800mA	700mA	0.475Ω ±20%	20MHz	Kit
LQH32PN220MNC□	22μH ±20%	650mA	550mA	0.685Ω ±20%	20MHz	Kit

Inductance Test Frequency: 1MHz Class of Magnetic Shield: Magnetic shield of magnetic powder in resin

Operating Temperature Range (Self-temperature rise is included): -40°C~+125°C

Operating Temperature Range (Self-temperature rise is not included): -40°C~+85°C

For reflow soldering only.

*1 When applied rated current to the products, inductance will be within ±30% of initial inductance value.

*2 When applied rated current to the products, self-temperature rise shall be limited to 40°C max.

*3 Keep the temperature (ambient temperature plus self-generation of heat) under 125°C.

Inductance-Frequency Characteristics (Typ.)

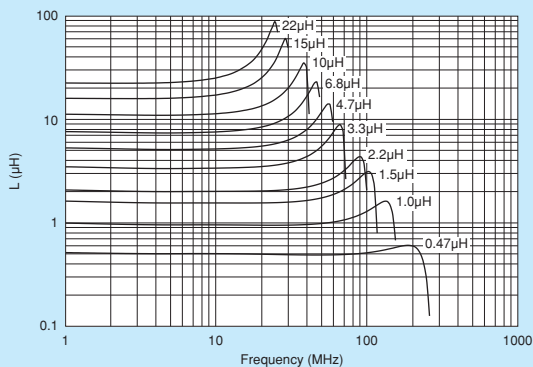

Inductance-Current Characteristics (Typ.)

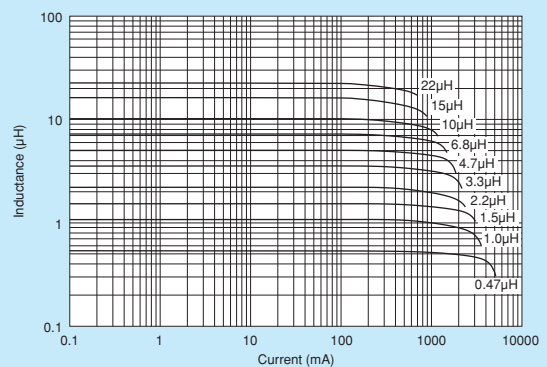

Continued on the following page.

Note • Please read rating and **CAUTION** (for storage, operating, rating, soldering, mounting and handling) in this catalog to prevent smoking and/or burning, etc.
• This catalog has only typical specifications. Therefore, please approve our product specifications or transact the approval sheet for product specifications before ordering.

Temperature Rise Characteristics (Typ.)

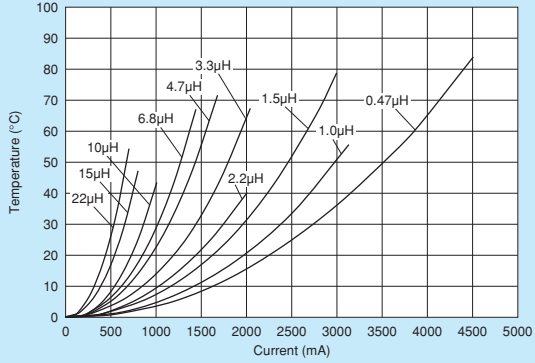

⚠Note • Please read rating and ⚠CAUTION (for storage, operating, rating, soldering, mounting and handling) in this catalog to prevent smoking and/or burning, etc.
• This catalog has only typical specifications. Therefore, please approve our product specifications or transact the approval sheet for product specifications before ordering.

LQH32PB_N0 Series 1210/3225 (inch/mm)

1.7mm max. Thickness, 105°C

■ Appearance/Dimensions

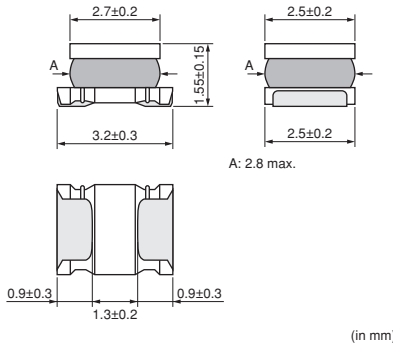

■ Packaging

Code	Packaging	Minimum Quantity
L	ø180mm Embossed Taping	2000
K	ø330mm Embossed Taping	7500



Refer to pages 102 to 106 for mounting information.

■ Rated Value (□: packaging code)

Part Number	Inductance	Rated Current ^{*1*3} (Based on Inductance Change)	Rated Current ^{*2*3} (Based on Temperature Rise)	DC Resistance	Self-Resonance Frequency (min.)	
LQH32PBR47NN0□	0.47μH ±30%	3400mA	2550mA	0.030Ω ±20%	100MHz	New Kit
LQH32PB1R0NN0□	1.0μH ±30%	2300mA	2050mA	0.045Ω ±20%	100MHz	New Kit
LQH32PB1R5NN0□	1.5μH ±30%	1750mA	1750mA	0.057Ω ±20%	70MHz	New Kit
LQH32PB2R2NN0□	2.2μH ±30%	1550mA	1600mA	0.076Ω ±20%	70MHz	New Kit
LQH32PB3R3NN0□	3.3μH ±30%	1250mA	1200mA	0.12Ω ±20%	50MHz	New Kit
LQH32PB4R7NN0□	4.7μH ±30%	1000mA	1000mA	0.18Ω ±20%	40MHz	New Kit
LQH32PB6R8NN0□	6.8μH ±30%	850mA	850mA	0.24Ω ±20%	40MHz	New Kit
LQH32PB100MN0□	10μH ±20%	750mA	700mA	0.38Ω ±20%	30MHz	New Kit
LQH32PB150MN0□	15μH ±20%	600mA	520mA	0.57Ω ±20%	20MHz	New Kit
LQH32PB220MN0□	22μH ±20%	500mA	450mA	0.81Ω ±20%	20MHz	New Kit
LQH32PB330MN0□	33μH ±20%	380mA	390mA	1.15Ω ±20%	13MHz	New Kit
LQH32PB470MN0□	47μH ±20%	330mA	310mA	1.78Ω ±20%	11MHz	New Kit
LQH32PB680MN0□	68μH ±20%	280mA	275mA	2.28Ω ±20%	11MHz	New Kit
LQH32PB101MN0□	100μH ±20%	180mA	250mA	2.7Ω ±20%	8MHz	New Kit
LQH32PB121MN0□	120μH ±20%	170mA	200mA	4.38Ω ±20%	8MHz	New Kit

Inductance Test Frequency: 1MHz Class of Magnetic Shield: Magnetic shield of magnetic powder in resin
 Operating Temperature Range (Self-temperature rise is included): -40°C~+125°C
 Operating Temperature Range (Self-temperature rise is not included): -40°C~+105°C
 For reflow soldering only.

*1 When applied rated current to the products, inductance will be within ±30% of initial inductance value.
 *2 When applied rated current to the products, self-temperature rise shall be limited to 40°C max.
 *3 Keep the temperature (ambient temperature plus self-generation of heat) under 125°C.

■ Inductance-Frequency Characteristics (Typ.)

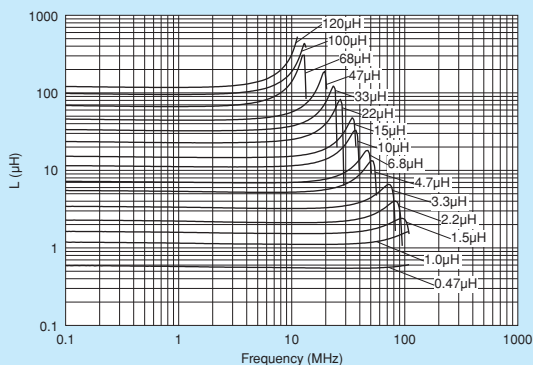

■ Inductance-Current Characteristics (Typ.)

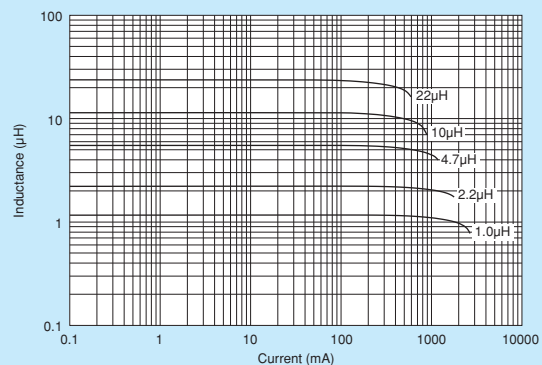

Continued on the following page.

△Note • Please read rating and △CAUTION (for storage, operating, rating, soldering, mounting and handling) in this catalog to prevent smoking and/or burning, etc.
 • This catalog has only typical specifications. Therefore, please approve our product specifications or transact the approval sheet for product specifications before ordering.

■ Temperature Rise Characteristics (Typ.)

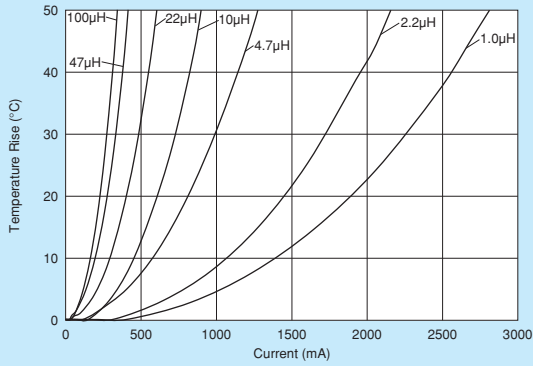

■ Derating of Rated Current

In operating temperature exceeding +85°C, derating of current is necessary for LQH32PB_N0 series. Please apply the derating curve shown in chart according to the operating temperature.

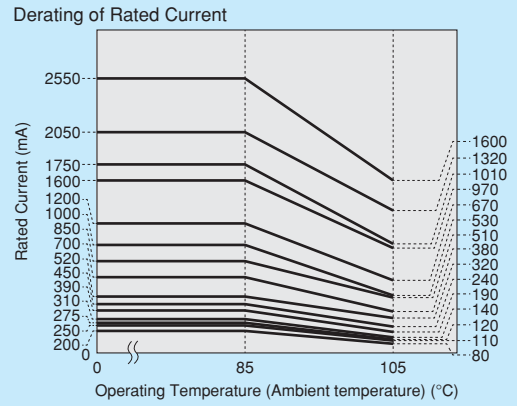

⚠Note • Please read rating and ⚠CAUTION (for storage, operating, rating, soldering, mounting and handling) in this catalog to prevent smoking and/or burning, etc.
• This catalog has only typical specifications. Therefore, please approve our product specifications or transact the approval sheet for product specifications before ordering.

LQH32PB_NC Series 1210/3225 (inch/mm)

1.7mm max. Thickness, 105°C

■ Appearance/Dimensions

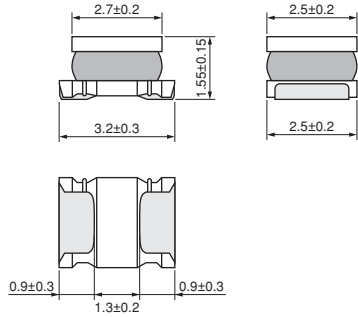

(in mm)

■ Packaging

Code	Packaging	Minimum Quantity
L	ø180mm Embossed Taping	2000
K	ø330mm Embossed Taping	7500



Refer to pages 102 to 106 for mounting information.

■ Rated Value (□: packaging code)

Part Number	Inductance	Rated Current ^{*1*3} (Based on Inductance Change)	Rated Current ^{*2*3} (Based on Temperature Rise)	DC Resistance	Self-Resonance Frequency (min.)	
LQH32PBR47NNC□	0.47μH ±30%	4400mA	2900mA	0.024Ω ±20%	100MHz	New Kit
LQH32PB1R0NNC□	1.0μH ±30%	3000mA	2500mA	0.036Ω ±20%	100MHz	New Kit
LQH32PB1R5NNC□	1.5μH ±30%	2600mA	2100mA	0.053Ω ±20%	70MHz	New Kit
LQH32PB2R2NNC□	2.2μH ±30%	2000mA	1850mA	0.064Ω ±20%	70MHz	New Kit
LQH32PB3R3NNC□	3.3μH ±30%	1900mA	1550mA	0.1Ω ±20%	50MHz	New Kit
LQH32PB4R7NNC□	4.7μH ±30%	1600mA	1200mA	0.155Ω ±20%	40MHz	New Kit
LQH32PB6R8NNC□	6.8μH ±30%	1300mA	1100mA	0.22Ω ±20%	40MHz	New Kit
LQH32PB100MNC□	10μH ±20%	1000mA	900mA	0.295Ω ±20%	30MHz	New Kit
LQH32PB150MNC□	15μH ±20%	800mA	700mA	0.475Ω ±20%	20MHz	New Kit
LQH32PB220MNC□	22μH ±20%	650mA	550mA	0.685Ω ±20%	20MHz	New Kit

Inductance Test Frequency: 1MHz Class of Magnetic Shield: Magnetic shield of magnetic powder in resin

Operating Temperature Range (Self-temperature rise is included): -40°C~+125°C

Operating Temperature Range (Self-temperature rise is not included): -40°C~+105°C

For reflow soldering only.

*1 When applied rated current to the products, inductance will be within ±30% of initial inductance value.

*2 When applied rated current to the products, self-temperature rise shall be limited to 40°C max.

*3 Keep the temperature (ambient temperature plus self-generation of heat) under 125°C.

■ Inductance-Frequency Characteristics (Typ.)

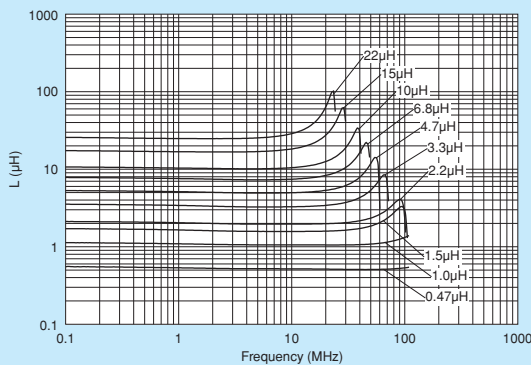

■ Inductance-Current Characteristics (Typ.)

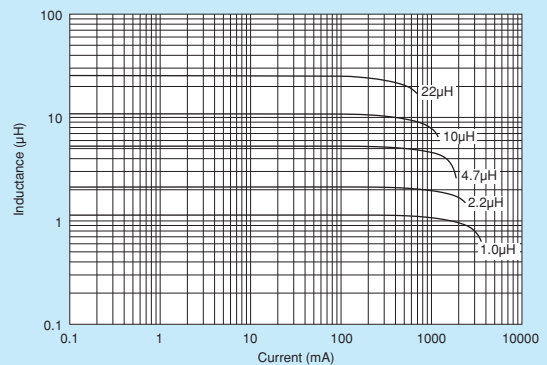

Continued on the following page.

△Note • Please read rating and △CAUTION (for storage, operating, rating, soldering, mounting and handling) in this catalog to prevent smoking and/or burning, etc.
• This catalog has only typical specifications. Therefore, please approve our product specifications or transact the approval sheet for product specifications before ordering.

Temperature Rise Characteristics (Typ.)

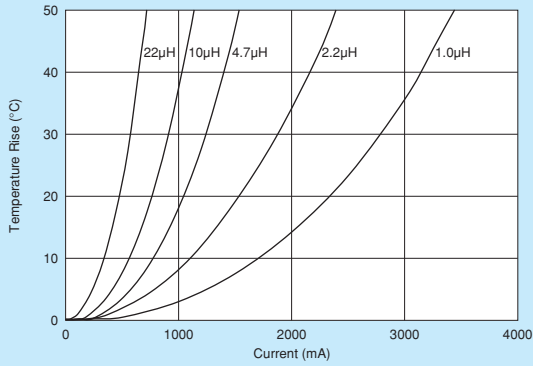

Derating of Rated Current

In operating temperature exceeding +85°C, derating of current is necessary for LQH32PB_NC series. Please apply the derating curve shown in chart according to the operating temperature.

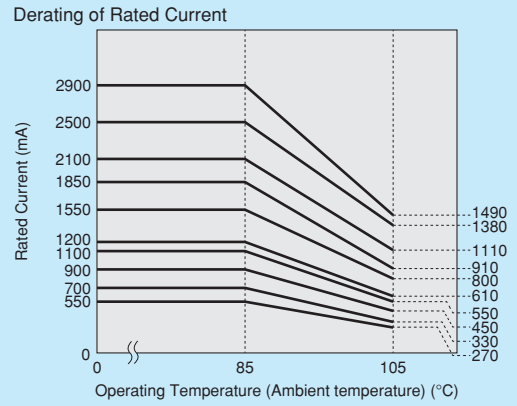

Note • Please read rating and CAUTION (for storage, operating, rating, soldering, mounting and handling) in this catalog to prevent smoking and/or burning, etc.
• This catalog has only typical specifications. Therefore, please approve our product specifications or transact the approval sheet for product specifications before ordering.

LQH43PN_26 Series 1812/4532 (inch/mm)

Size Code 1812 (4532) in inch (in mm), 2.8mm max. Thickness

■ Appearance/Dimensions

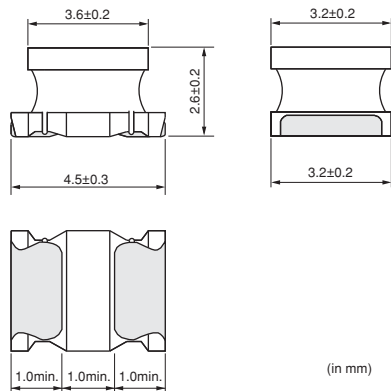

■ Packaging

Code	Packaging	Minimum Quantity
L	ø180mm Embossed Taping	500
K	ø330mm Embossed Taping	2500



Refer to pages 102 to 106 for mounting information.

■ Rated Value (□: packaging code)

Part Number	Inductance	Rated Current ^{*1*3} (Based on Inductance Change)	Rated Current ^{*2*3} (Based on Temperature Rise)	DC Resistance	Self-Resonance Frequency (min.)	
LQH43PN1R0N26□	1.0μH ±30%	3400mA	3300mA	0.026Ω ±20%	100MHz	Kit
LQH43PN2R2M26□	2.2μH ±20%	2300mA	2500mA	0.042Ω ±20%	45MHz	Kit
LQH43PN3R3M26□	3.3μH ±20%	1800mA	2100mA	0.052Ω ±20%	40MHz	Kit
LQH43PN4R7M26□	4.7μH ±20%	1400mA	1600mA	0.075Ω ±20%	35MHz	Kit
LQH43PN6R8M26□	6.8μH ±20%	1200mA	1400mA	0.098Ω ±20%	30MHz	Kit
LQH43PN8R2M26□	8.2μH ±20%	1100mA	1300mA	0.128Ω ±20%	25MHz	Kit
LQH43PN100M26□	10μH ±20%	1050mA	1170mA	0.147Ω ±20%	20MHz	Kit
LQH43PN220M26□	22μH ±20%	700mA	780mA	0.327Ω ±20%	15MHz	Kit
LQH43PN470M26□	47μH ±20%	470mA	520mA	0.718Ω ±20%	8MHz	Kit
LQH43PN101M26□	100μH ±20%	320mA	320mA	1.538Ω ±20%	4MHz	Kit
LQH43PN151M26□	150μH ±20%	280mA	260mA	2.362Ω ±20%	3MHz	Kit
LQH43PN221M26□	220μH ±20%	220mA	240mA	2.900Ω ±20%	2MHz	Kit

Inductance Test Frequency: 1MHz Class of Magnetic Shield: Magnetic shield of magnetic powder in resin
 Operating Temperature Range (Self-temperature rise is not included): -40°C~+85°C
 *1 When applied rated current to the products, inductance will be within ±30% of initial inductance value.
 *2 When applied rated current to the products, self-temperature rise shall be limited to 40°C max.
 *3 Keep the temperature (ambient temperature plus self-generation of heat) under 125°C.

■ Inductance-Frequency Characteristics (Typ.)

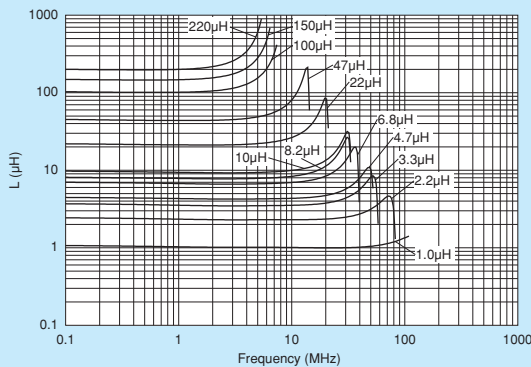

■ Inductance-Current Characteristics (Typ.)

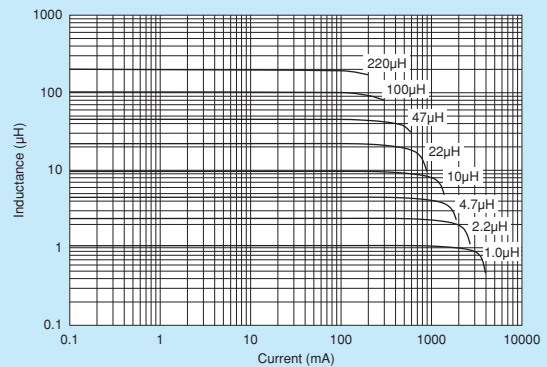

Continued on the following page.

△Note • Please read rating and △CAUTION (for storage, operating, rating, soldering, mounting and handling) in this catalog to prevent smoking and/or burning, etc.
 • This catalog has only typical specifications. Therefore, please approve our product specifications or transact the approval sheet for product specifications before ordering.

Temperature Rise Characteristics (Typ.)

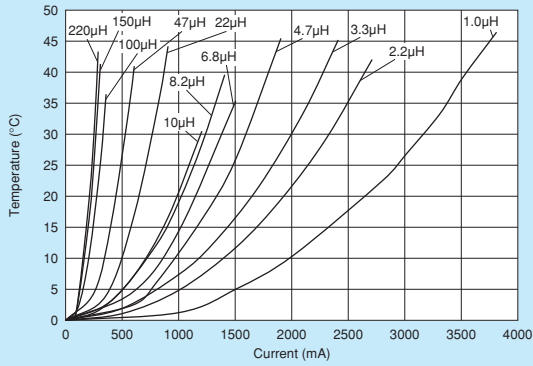

⚠Note • Please read rating and ⚠CAUTION (for storage, operating, rating, soldering, mounting and handling) in this catalog to prevent smoking and/or burning, etc.
• This catalog has only typical specifications. Therefore, please approve our product specifications or transact the approval sheet for product specifications before ordering.

LQH43PB_26 Series 1812/4532 (inch/mm)

For Automotive Use *Expect for the portion asked for high reliability ex. power train

■ Appearance/Dimensions

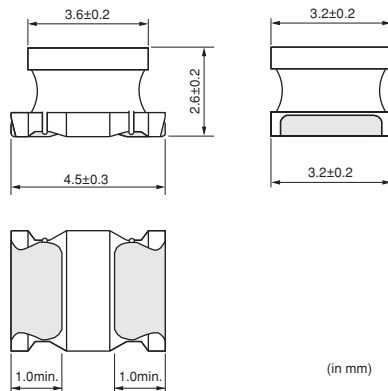

■ Packaging

Code	Packaging	Minimum Quantity
L	ø180mm Embossed Taping	500
K	ø330mm Embossed Taping	2500



Refer to pages 102 to 106 for mounting information.

■ Rated Value (□: packaging code)

Part Number	Inductance	Rated Current ^{*1*3} (Based on Inductance Change)	Rated Current ^{*2*3} (Based on Temperature Rise)	DC Resistance	Self-Resonance Frequency (min.)	
LQH43PB1R0N26□	1.0μH ±30%	3400mA	3300mA	0.026Ω ±20%	100MHz	New
LQH43PB2R2M26□	2.2μH ±20%	2300mA	2500mA	0.042Ω ±20%	45MHz	New
LQH43PB3R3M26□	3.3μH ±20%	1800mA	2100mA	0.052Ω ±20%	40MHz	New
LQH43PB4R7M26□	4.7μH ±20%	1400mA	1600mA	0.075Ω ±20%	35MHz	New
LQH43PB6R8M26□	6.8μH ±20%	1200mA	1400mA	0.098Ω ±20%	30MHz	New
LQH43PB8R2M26□	8.2μH ±20%	1100mA	1300mA	0.128Ω ±20%	25MHz	New
LQH43PB100M26□	10μH ±20%	1050mA	1170mA	0.147Ω ±20%	20MHz	New
LQH43PB220M26□	22μH ±20%	700mA	780mA	0.327Ω ±20%	15MHz	New
LQH43PB470M26□	47μH ±20%	470mA	520mA	0.718Ω ±20%	8MHz	New
LQH43PB101M26□	100μH ±20%	320mA	320mA	1.538Ω ±20%	4MHz	New
LQH43PB151M26□	150μH ±20%	280mA	260mA	2.362Ω ±20%	3MHz	New
LQH43PB221M26□	220μH ±20%	220mA	240mA	2.900Ω ±20%	2MHz	New

Inductance Test Frequency: 1MHz Class of Magnetic Shield: Magnetic shield of magnetic powder in resin
 Operating Temperature Range (Self-temperature rise is included): -40°C~+125°C
 Operating Temperature Range (Self-temperature rise is not included): -40°C~+105°C
 For reflow soldering only.

*1 When applied rated current to the products, inductance will be within ±30% of initial inductance value.
 *2 When applied rated current to the products, self-temperature rise shall be limited to 40°C max.
 *3 Keep the temperature (ambient temperature plus self-generation of heat) under 125°C.

■ Inductance-Frequency Characteristics (Typ.)

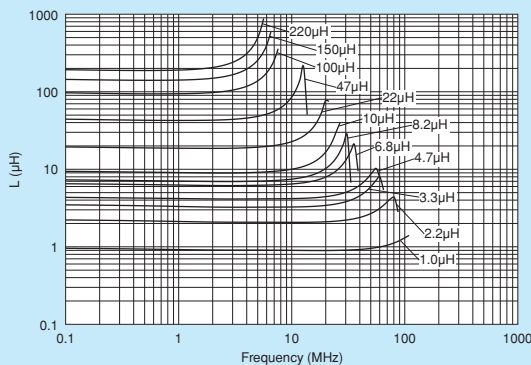

■ Inductance-Current Characteristics (Typ.)

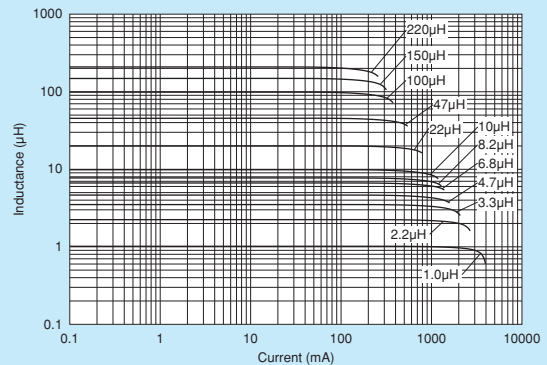

Continued on the following page.

△Note • Please read rating and △CAUTION (for storage, operating, rating, soldering, mounting and handling) in this catalog to prevent smoking and/or burning, etc.
 • This catalog has only typical specifications. Therefore, please approve our product specifications or transact the approval sheet for product specifications before ordering.

■ Temperature Rise Characteristics (Typ.)

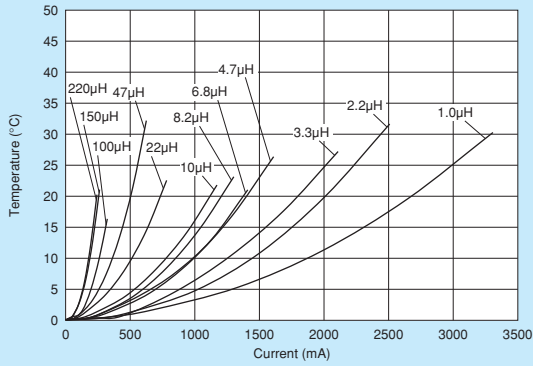

■ Derating of Rated Current

In operating temperature exceeding +85°C, derating of current is necessary for LQH43PB series. Please apply the derating curve shown in chart according to the operating temperature.

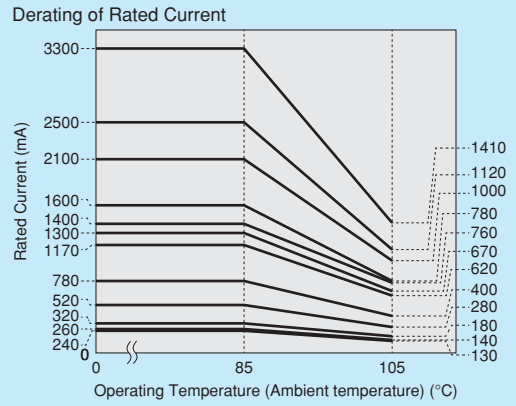

⚠Note • Please read rating and ⚠CAUTION (for storage, operating, rating, soldering, mounting and handling) in this catalog to prevent smoking and/or burning, etc.
• This catalog has only typical specifications. Therefore, please approve our product specifications or transact the approval sheet for product specifications before ordering.

LQH44PN_PO Series 1515/4040 (inch/mm)

Size Code 1515 (4040) in inch (in mm), 1.8mm max. Thickness

■ Appearance/ Dimensions

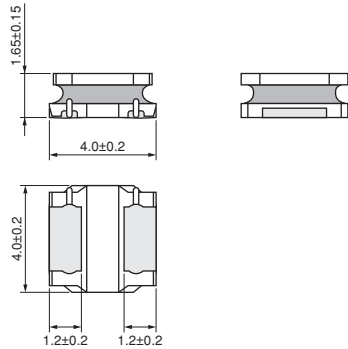

■ Packaging

Code	Packaging	Minimum Quantity
L	ø180mm Embossed Taping	1000
K	ø330mm Embossed Taping	3500



Refer to pages 102 to 106 for mounting information.

■ Rated Value (□: packaging code)

Part Number	Inductance	Rated Current ^{*1*3} (Based on Inductance Change)	Rated Current ^{*2*3} (Based on Temperature Rise)	DC Resistance	Self-Resonance Frequency (min.)	Kit
LQH44PN1R0NP0□	1.0μH ±30%	2950mA	2450mA	0.030Ω ±20%	90MHz	Kit
LQH44PN2R2MP0□	2.2μH ±20%	2500mA	1800mA	0.049Ω ±20%	70MHz	Kit
LQH44PN3R3MP0□	3.3μH ±20%	2100mA	1770mA	0.065Ω ±20%	50MHz	Kit
LQH44PN4R7MP0□	4.7μH ±20%	1700mA	1700mA	0.080Ω ±20%	40MHz	Kit
LQH44PN6R8MP0□	6.8μH ±20%	1400mA	1340mA	0.12Ω ±20%	35MHz	Kit
LQH44PN100MP0□	10μH ±20%	1150mA	1170mA	0.16Ω ±20%	25MHz	Kit
LQH44PN220MP0□	22μH ±20%	800mA	790mA	0.37Ω ±20%	17MHz	Kit

Inductance Test Frequency: 1MHz Class of Magnetic Shield: Magnetic shield of magnetic powder in resin
 Operating Temperature Range (Self-temperature rise is included): -40°C~+125°C
 Operating Temperature Range (Self-temperature rise is not included): -40°C~+85°C
 For reflow soldering only.

*1 When applied rated current to the products, inductance will be within ±30% of initial inductance value.
 *2 When applied rated current to the products, self-temperature rise shall be limited to 40°C max.
 *3 Keep the temperature (ambient temperature plus self-generation of heat) under 125°C.

■ Inductance-Frequency Characteristics (Typ.)

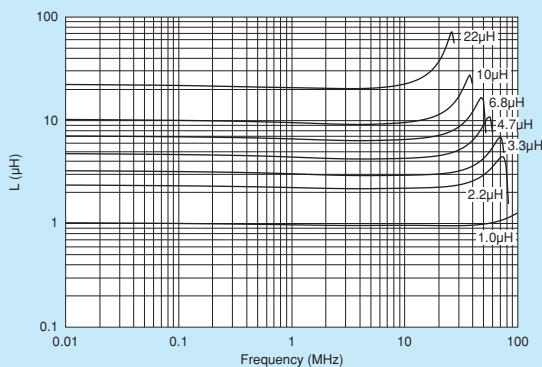

■ Inductance-Current Characteristics (Typ.)

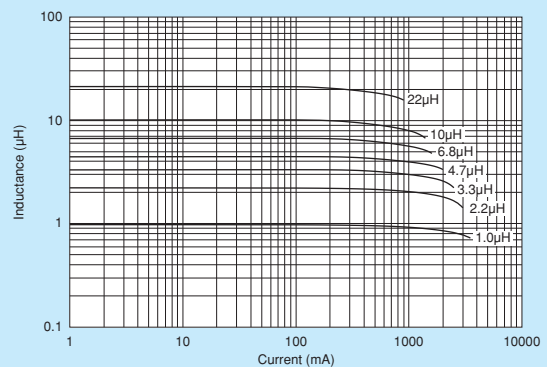

Continued on the following page.

△Note • Please read rating and △CAUTION (for storage, operating, rating, soldering, mounting and handling) in this catalog to prevent smoking and/or burning, etc.
 • This catalog has only typical specifications. Therefore, please approve our product specifications or transact the approval sheet for product specifications before ordering.

Temperature Rise Characteristics (Typ.)

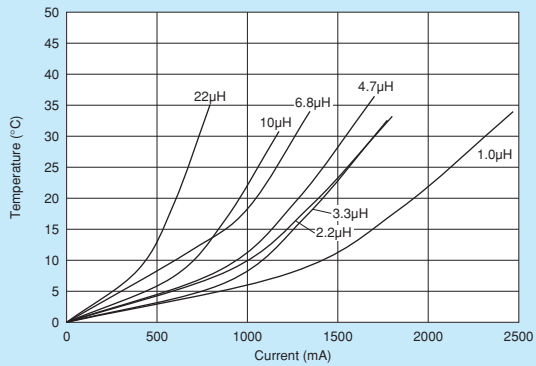

Note • Please read rating and CAUTION (for storage, operating, rating, soldering, mounting and handling) in this catalog to prevent smoking and/or burning, etc.
• This catalog has only typical specifications. Therefore, please approve our product specifications or transact the approval sheet for product specifications before ordering.

LQH44PN_J0 Series 1515/4040 (inch/mm)

Size Code 1515 (4040) in inch (in mm), 1.2mm max. Thickness

■ Appearance/Dimensions

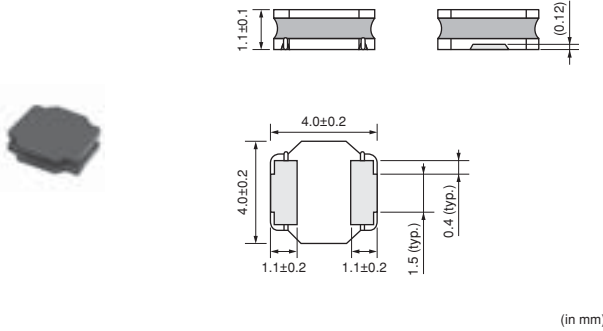

■ Packaging

Code	Packaging	Minimum Quantity
L	ø180mm Embossed Taping	1000
K	ø330mm Embossed Taping	3500



Refer to pages 102 to 106 for mounting information.

■ Rated Value (□: packaging code)

Part Number	Inductance	Rated Current ^{*1*3} (Based on Inductance Change)	Rated Current ^{*2*3} (Based on Temperature Rise)	DC Resistance	Self-Resonance Frequency (min.)	
LQH44PN1R0NJ0□	1.0µH ±30%	2000mA	1530mA	0.048Ω ±20%	130MHz	Kit
LQH44PN1R5MJ0□	1.5µH ±20%	1600mA	1380mA	0.061Ω ±20%	90MHz	Kit
LQH44PN2R2MJ0□	2.2µH ±20%	1320mA	1230mA	0.074Ω ±20%	68MHz	Kit
LQH44PN3R3MJ0□	3.3µH ±20%	900mA	1000mA	0.088Ω ±20%	55MHz	Kit
LQH44PN4R7MJ0□	4.7µH ±20%	840mA	980mA	0.117Ω ±20%	50MHz	Kit
LQH44PN6R8MJ0□	6.8µH ±20%	720mA	860mA	0.143Ω ±20%	38MHz	Kit
LQH44PN100MJ0□	10µH ±20%	560mA	790mA	0.207Ω ±20%	30MHz	Kit
LQH44PN150MJ0□	15µH ±20%	430mA	610mA	0.385Ω ±20%	25MHz	Kit
LQH44PN220MJ0□	22µH ±20%	400mA	550mA	0.480Ω ±20%	18MHz	Kit
LQH44PN330MJ0□	33µH ±20%	360mA	430mA	0.740Ω ±20%	15MHz	Kit
LQH44PN470MJ0□	47µH ±20%	300mA	380mA	1.014Ω ±20%	13MHz	Kit

Inductance Test Frequency: 100kHz Class of Magnetic Shield: Magnetic shield of magnetic powder in resin

Operating Temperature Range (Self-temperature rise is included): -40°C~+125°C

Operating Temperature Range (Self-temperature rise is not included): -40°C~+85°C

For reflow soldering only.

*1 When applied rated current to the products, inductance will be within ±30% of initial inductance value.

*2 When applied rated current to the products, self-temperature rise shall be limited to 40°C max.

*3 Keep the temperature (ambient temperature plus self-generation of heat) under 125°C.

■ Inductance-Frequency Characteristics (Typ.)

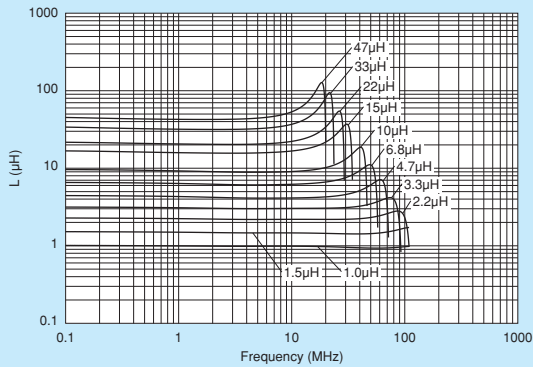

■ Inductance-Current Characteristics (Typ.)

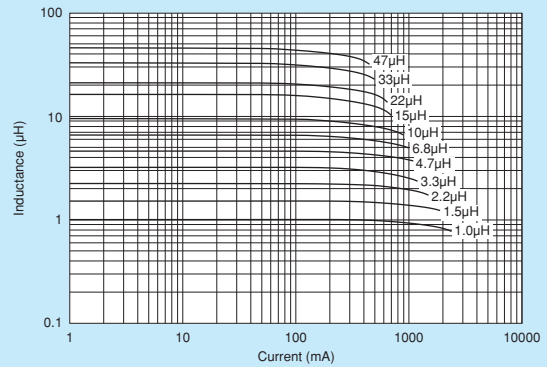

Continued on the following page.

△Note • Please read rating and △CAUTION (for storage, operating, rating, soldering, mounting and handling) in this catalog to prevent smoking and/or burning, etc.
• This catalog has only typical specifications. Therefore, please approve our product specifications or transact the approval sheet for product specifications before ordering.

■ Temperature Rise Characteristics (Typ.)

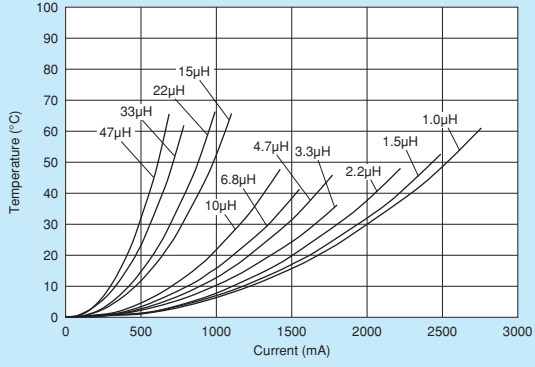

⚠Note • Please read rating and ⚠CAUTION (for storage, operating, rating, soldering, mounting and handling) in this catalog to prevent smoking and/or burning, etc.
• This catalog has only typical specifications. Therefore, please approve our product specifications or transact the approval sheet for product specifications before ordering.

LQH5BPN_T0 Series 2020/5050 (inch/mm)

Size Code 2020 (5050) in inch (in mm), 2.2mm max. Thickness

■ Appearance/Dimensions

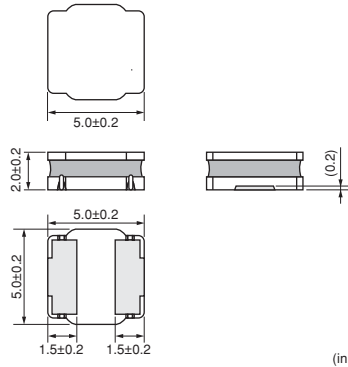

(in mm)

■ Packaging

Code	Packaging	Minimum Quantity
L	ø180mm Embossed Taping	500
K	ø330mm Embossed Taping	3000



Refer to pages 102 to 106 for mounting information.

■ Rated Value (□: packaging code)

Part Number	Inductance	Rated Current ^{*1*3} (Based on Inductance Change)	Rated Current ^{*2*3} (Based on Temperature Rise)	DC Resistance	Self-Resonance Frequency (min.)	
LQH5BPNR47NT0□	0.47μH ±30%	7.7A	4.0A	0.012Ω ±20%	220MHz	Kit
LQH5BPN1R0NT0□	1.0μH ±30%	5.8A	3.1A	0.019Ω ±20%	90MHz	Kit
LQH5BPN1R2NT0□	1.2μH ±30%	5.4A	3.1A	0.019Ω ±20%	90MHz	Kit
LQH5BPN1R5NT0□	1.5μH ±30%	5.0A	3.0A	0.024Ω ±20%	70MHz	Kit
LQH5BPN2R2NT0□	2.2μH ±30%	4.0A	2.6A	0.030Ω ±20%	55MHz	Kit
LQH5BPN2R7NT0□	2.7μH ±30%	3.8A	2.5A	0.035Ω ±20%	50MHz	Kit
LQH5BPN3R3NT0□	3.3μH ±30%	3.5A	2.3A	0.044Ω ±20%	40MHz	Kit
LQH5BPN4R7NT0□	4.7μH ±30%	3.0A	2.0A	0.058Ω ±20%	40MHz	Kit
LQH5BPN6R8NT0□	6.8μH ±30%	2.5A	1.65A	0.083Ω ±20%	30MHz	Kit
LQH5BPN100MT0□	10μH ±20%	2.0A	1.60A	0.106Ω ±20%	25MHz	Kit
LQH5BPN150MT0□	15μH ±20%	1.6A	1.20A	0.187Ω ±20%	18MHz	Kit
LQH5BPN220MT0□	22μH ±20%	1.4A	1.05A	0.259Ω ±20%	15MHz	Kit

Inductance Test Frequency: 100kHz Class of Magnetic Shield: Magnetic shield of magnetic powder in resin

Operating Temperature Range (Self-temperature rise is included): -40°C~+125°C

Operating Temperature Range (Self-temperature rise is not included): -40°C~+85°C

For reflow soldering only.

*1 When applied rated current to the products, inductance will be within ±30% of initial inductance value.

*2 When applied rated current to the products, self-temperature rise shall be limited to 40°C max.

*3 Keep the temperature (ambient temperature plus self-generation of heat) under 125°C.

■ Inductance-Frequency Characteristics (Typ.)

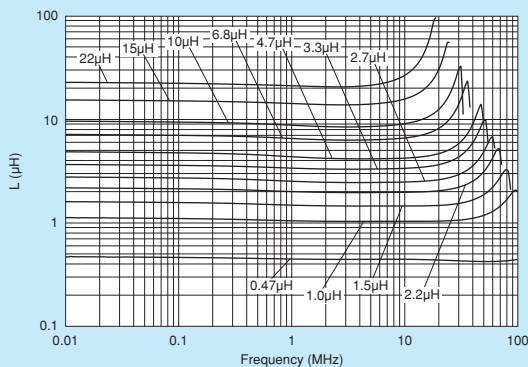

■ Inductance-Current Characteristics (Typ.)

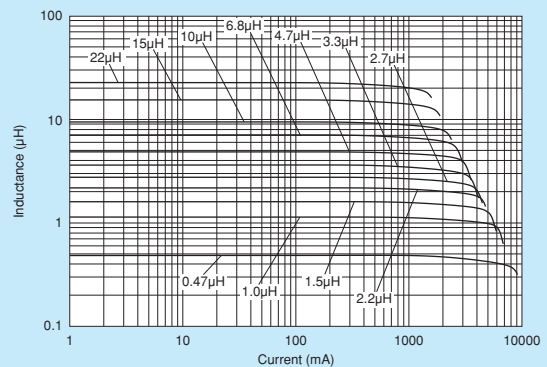

Continued on the following page.

△Note • Please read rating and △CAUTION (for storage, operating, rating, soldering, mounting and handling) in this catalog to prevent smoking and/or burning, etc.
• This catalog has only typical specifications. Therefore, please approve our product specifications or transact the approval sheet for product specifications before ordering.

Temperature Rise Characteristics (Typ.)

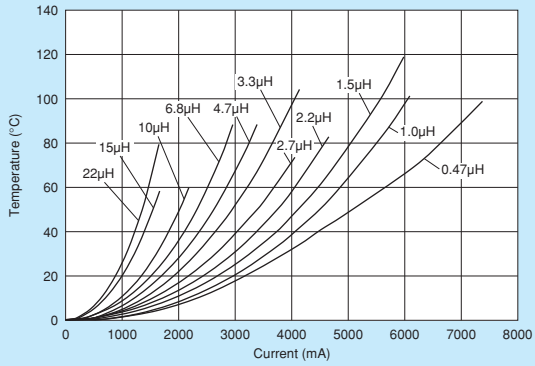

Note • Please read rating and CAUTION (for storage, operating, rating, soldering, mounting and handling) in this catalog to prevent smoking and/or burning, etc.
• This catalog has only typical specifications. Therefore, please approve our product specifications or transact the approval sheet for product specifications before ordering.

LQH5BPB_T0 Series 2020/5050 (inch/mm)

For Automotive Use *Expect for the portion asked for high reliability ex. power train

■ Appearance/Dimensions

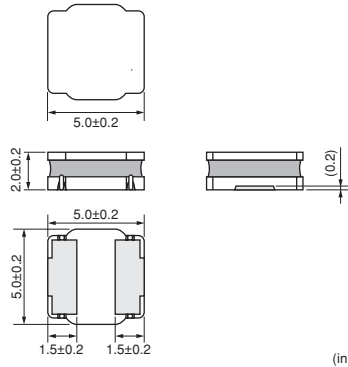

■ Packaging

Code	Packaging	Minimum Quantity
L	ø180mm Embossed Taping	500
K	ø330mm Embossed Taping	3000



Refer to pages 102 to 106 for mounting information.

■ Rated Value (□: packaging code)

Part Number	Inductance	Rated Current ^{*1*3} (Based on Inductance Change)	Rated Current ^{*2*3} (Based on Temperature Rise)	DC Resistance	Self-Resonance Frequency (min.)	
LQH5BPBR47NT0□	0.47μH ±30%	7.7A	4A	0.012Ω ±20%	220MHz	New
LQH5BPB1R0NT0□	1μH ±30%	5.8A	3.1A	0.019Ω ±20%	90MHz	New
LQH5BPB1R2NT0□	1.2μH ±30%	5.4A	3.1A	0.019Ω ±20%	90MHz	New
LQH5BPB1R5NT0□	1.5μH ±30%	5.0A	3A	0.024Ω ±20%	70MHz	New
LQH5BPB2R2NT0□	2.2μH ±30%	4.0A	2.6A	0.030Ω ±20%	55MHz	New
LQH5BPB2R7NT0□	2.7μH ±30%	3.8A	2.5A	0.035Ω ±20%	50MHz	New
LQH5BPB3R3NT0□	3.3μH ±30%	3.5A	2.3A	0.044Ω ±20%	40MHz	New
LQH5BPB4R7NT0□	4.7μH ±30%	3.0A	2A	0.058Ω ±20%	40MHz	New
LQH5BPB6R8NT0□	6.8μH ±30%	2.5A	1.65A	0.083Ω ±20%	30MHz	New
LQH5BPB100MT0□	10μH ±20%	2.0A	1.6A	0.106Ω ±20%	25MHz	New
LQH5BPB150MT0□	15μH ±20%	1.6A	1.2A	0.187Ω ±20%	18MHz	New
LQH5BPB220MT0□	22μH ±20%	1.4A	1.05A	0.259Ω ±20%	15MHz	New

Inductance Test Frequency: 100kHz Class of Magnetic Shield: Magnetic shield of magnetic powder in resin

Operating Temperature Range (Self-temperature rise is included): -40°C~+125°C

Operating Temperature Range (Self-temperature rise is not included): -40°C~+105°C

For reflow soldering only.

*1 When applied rated current to the products, inductance will be within ±30% of initial inductance value.

*2 When applied rated current to the products, self-temperature rise shall be limited to 40°C max.

*3 Keep the temperature (ambient temperature plus self-generation of heat) under 125°C.

■ Inductance-Frequency Characteristics (Typ.)

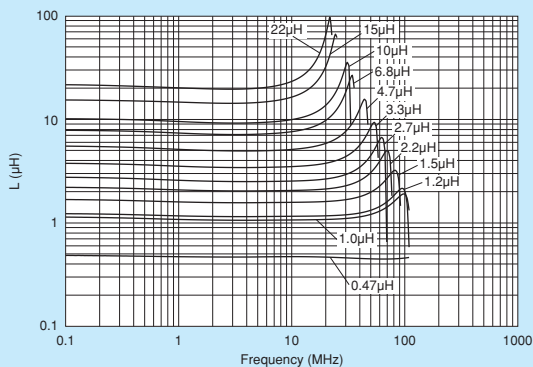

■ Inductance-Current Characteristics (Typ.)

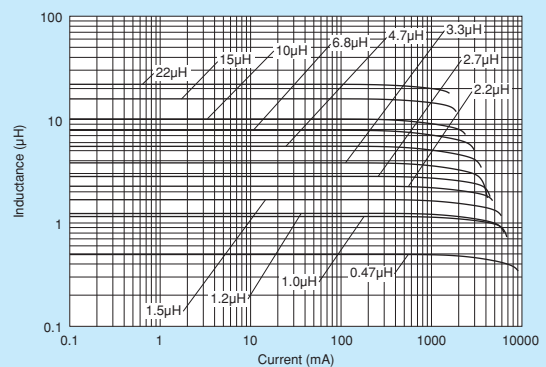

Continued on the following page.

△Note • Please read rating and △CAUTION (for storage, operating, rating, soldering, mounting and handling) in this catalog to prevent smoking and/or burning, etc.
• This catalog has only typical specifications. Therefore, please approve our product specifications or transact the approval sheet for product specifications before ordering.

■ Temperature Rise Characteristics (Typ.)

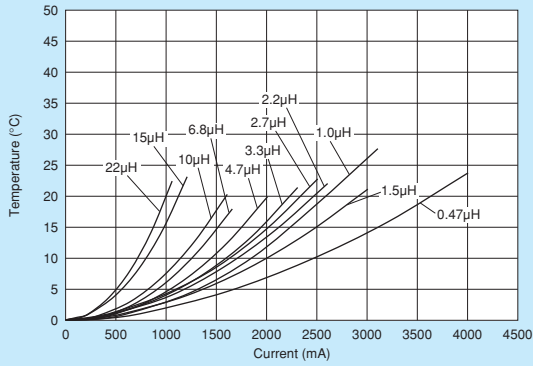

■ Derating of Rated Current

In operating temperature exceeding +85°C, derating of current is necessary for LQH5BPB series. Please apply the derating curve shown in chart according to the operating temperature.

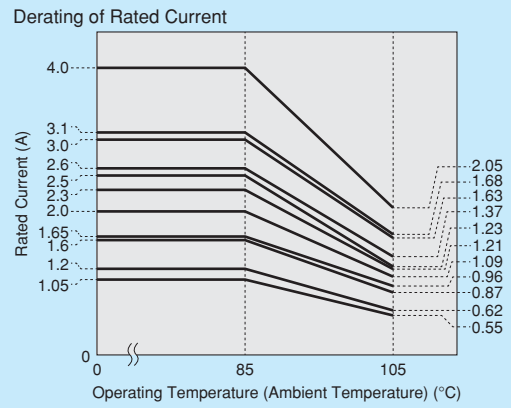

⚠Note • Please read rating and ⚠CAUTION (for storage, operating, rating, soldering, mounting and handling) in this catalog to prevent smoking and/or burning, etc.
• This catalog has only typical specifications. Therefore, please approve our product specifications or transact the approval sheet for product specifications before ordering.

LQM18FN_00 Series 0603/1608 (inch/mm)

Size Code 0603 (1608) in inch (in mm)

Appearance/Dimensions

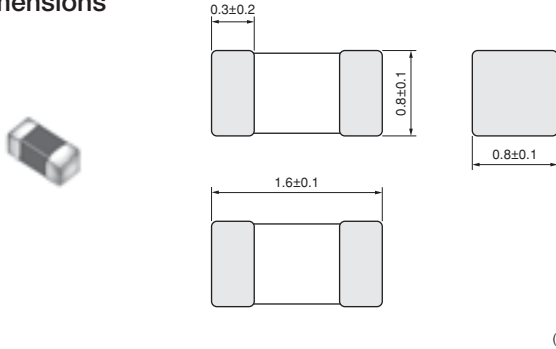

Packaging

Code	Packaging	Minimum Quantity
D	ø180mm Paper Taping	4000
J	ø330mm Paper Taping	10000
B	Packing in Bulk	1000



Refer to pages 102 to 106 for mounting information.

Rated Value (□: packaging code)

Part Number	Inductance	Inductance Test Frequency	Rated Current	DC Resistance	Self-Resonance Frequency (min.)	
LQM18FN1R0M00□	1.0μH ±20%	1MHz	150mA	0.20 Ω ±30%	120MHz	Kit
LQM18FN2R2M00□	2.2μH ±20%	1MHz	120mA	0.40 Ω ±30%	80MHz	Kit
LQM18FN4R7M00□	4.7μH ±20%	1MHz	80mA	0.60 Ω ±30%	50MHz	Kit
LQM18FN100M00□	10μH ±20%	1MHz	50mA	0.90 Ω ±30%	30MHz	Kit

Class of Magnetic Shield: Magnetic shield of ferrite
 Operating Temperature Range (Self-temperature rise is not included): -55°C~+125°C

Impedance-Frequency Characteristics (Typ.)

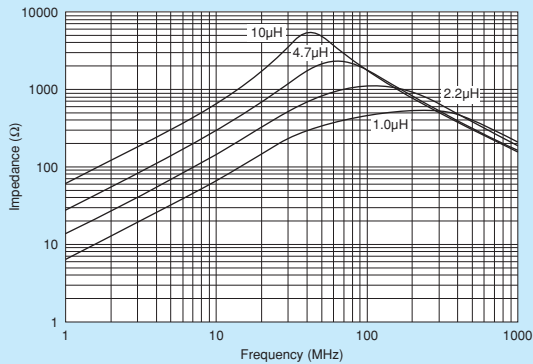

Inductance-Current Characteristics (Typ.)

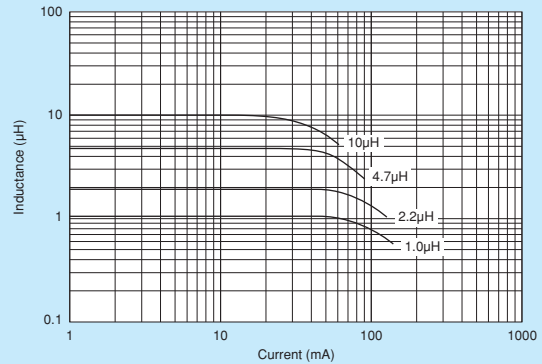

△Note • Please read rating and △CAUTION (for storage, operating, rating, soldering, mounting and handling) in this catalog to prevent smoking and/or burning, etc.
 • This catalog has only typical specifications. Therefore, please approve our product specifications or transact the approval sheet for product specifications before ordering.

LQM21DN_00 Series 0805/2012 (inch/mm)

Low DC Resistance Type

Appearance/Dimensions

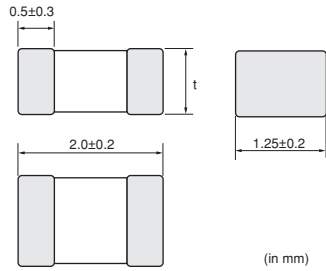

Dimension of t	Inductance: 1.0 to 10 μ H	0.85 \pm 0.2
	Inductance: 22 to 47 μ H	1.25 \pm 0.2

Packaging

Code	Packaging	Minimum Quantity
D	ϕ 180mm Paper Taping	4000
L	ϕ 180mm Embossed Taping	3000
J	ϕ 330mm Paper Taping	10000
K	ϕ 330mm Embossed Taping	10000
B	Packing in Bulk	1000



Refer to pages 102 to 106 for mounting information.

Rated Value (□: packaging code)

Part Number	Inductance	Inductance Test Frequency	Rated Current	Max. of DC Resistance	Self-Resonance Frequency (min.)
LQM21DN1R0N00□	1.0 μ H \pm 30%	1MHz	60mA	0.10 Ω	75MHz
LQM21DN2R2N00□	2.2 μ H \pm 30%	1MHz	40mA	0.17 Ω	50MHz
LQM21DN4R7N00□	4.7 μ H \pm 30%	1MHz	30mA	0.30 Ω	35MHz
LQM21DN100N00□	10 μ H \pm 30%	1MHz	15mA	0.50 Ω	24MHz
LQM21DN220N00□	22 μ H \pm 30%	1MHz	13mA	0.65 Ω	16MHz
LQM21DN470N00□	47 μ H \pm 30%	1MHz	7.0mA	1.20 Ω	7.5MHz

Class of Magnetic Shield: Magnetic shield of ferrite
 Operating Temperature Range (Self-temperature rise is not included): -40°C~+85°C

Impedance-Frequency Characteristics (Typ.)

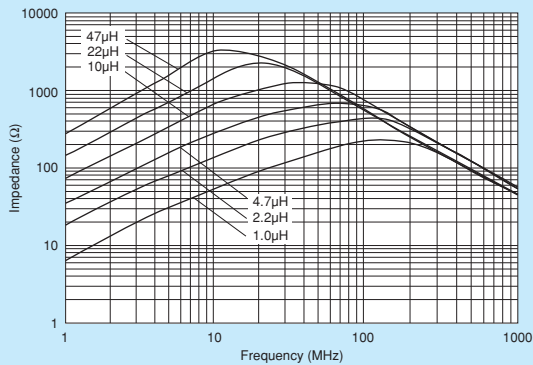

Inductance-Current Characteristics (Typ.)

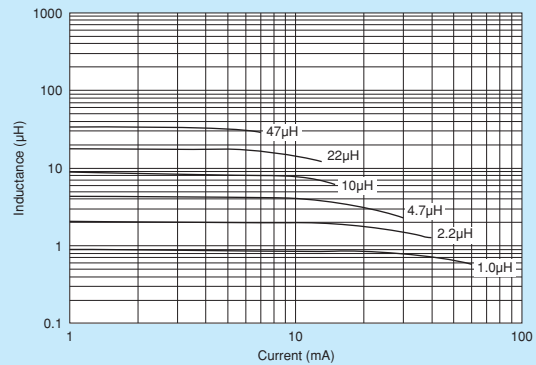

Note • Please read rating and CAUTION (for storage, operating, rating, soldering, mounting and handling) in this catalog to prevent smoking and/or burning, etc.
 • This catalog has only typical specifications. Therefore, please approve our product specifications or transact the approval sheet for product specifications before ordering.

LQM21FN_00 Series 0805/2012 (inch/mm)

Bias Current Characteristics Improved

Appearance/Dimensions

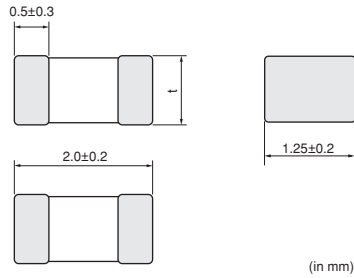

Dimension of t	Inductance: 1.0 to 2.2μH	0.85±0.2
	Inductance: 4.7 to 47μH	1.25±0.2

(in mm)

Packaging

Code	Packaging	Minimum Quantity
D	ø180mm Paper Taping	4000
L	ø180mm Embossed Taping	3000
J	ø330mm Paper Taping	10000
K	ø330mm Embossed Taping	10000
B	Packing in Bulk	1000



Refer to pages 102 to 106 for mounting information.

Rated Value (□: packaging code)

Part Number	Inductance	Inductance Test Frequency	Rated Current	DC Resistance	Self-Resonance Frequency (min.)	
LQM21FN1R0N00□	1.0μH ±30%	1MHz	220mA	0.20 Ω ±30%	105MHz	Kit
LQM21FN2R2N00□	2.2μH ±30%	1MHz	150mA	0.28 Ω ±30%	70MHz	Kit
LQM21FN4R7N00□	4.7μH ±30%	1MHz	80mA	0.30 Ω ±30%	25MHz	
LQM21FN100N00□	10μH ±30%	1MHz	60mA	0.50 Ω ±30%	15MHz	
LQM21FN220N00□	22μH ±30%	1MHz	13mA	0.35 Ω ±30%	15MHz	Kit
LQM21FN470N00□	47μH ±30%	1MHz	7.0mA	0.60 Ω ±30%	7.5MHz	Kit

Class of Magnetic Shield: Magnetic shield of ferrite
 Operating Temperature Range (Self-temperature rise is not included): -40°C~+85°C

Impedance-Frequency Characteristics (Typ.)

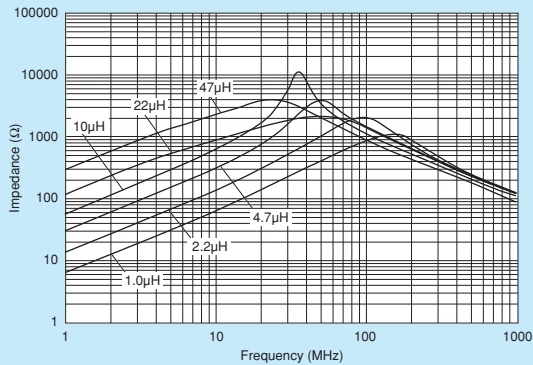

Inductance-Current Characteristics (Typ.)

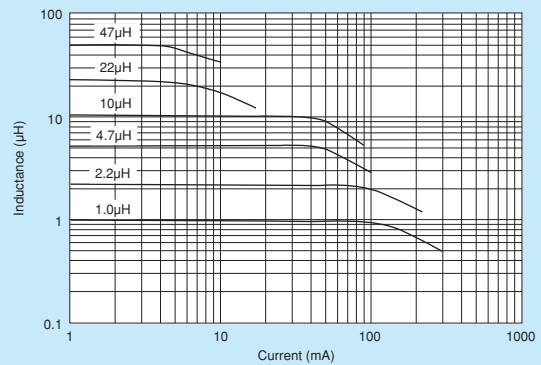

Note • Please read rating and CAUTION (for storage, operating, rating, soldering, mounting and handling) in this catalog to prevent smoking and/or burning, etc.
 • This catalog has only typical specifications. Therefore, please approve our product specifications or transact the approval sheet for product specifications before ordering.

LQM21FN_70 Series 0805/2012 (inch/mm)

Large Current

■ Appearance/Dimensions

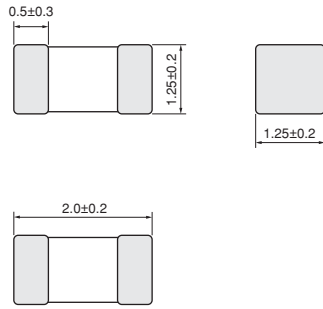

(in mm)

■ Packaging

Code	Packaging	Minimum Quantity
L	ø180mm Embossed Taping	3000
B	Packing in Bulk	1000



Refer to pages 102 to 106 for mounting information.

■ Rated Value (□: packaging code)

Part Number	Inductance	Inductance Test Frequency	Rated Current	DC Resistance	Self-Resonance Frequency (min.)	
LQM21FN4R7M70□	4.7μH ±20%	1MHz	120mA	0.35Ω ±30%	25MHz	Kit
LQM21FN100M70□	10μH ±20%	1MHz	100mA	0.60Ω ±30%	15MHz	Kit

Class of Magnetic Shield: Magnetic shield of ferrite
 Operating Temperature Range (Self-temperature rise is not included): -55°C~+125°C

■ Impedance-Frequency Characteristics (Typ.)

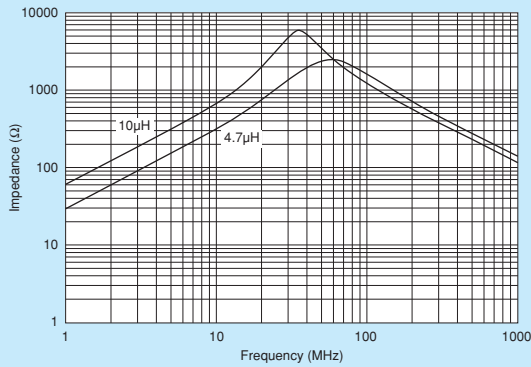

■ Inductance-Current Characteristics (Typ.)

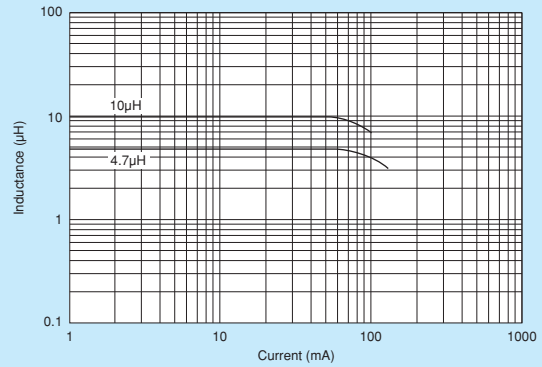

⚠Note • Please read rating and ⚠CAUTION (for storage, operating, rating, soldering, mounting and handling) in this catalog to prevent smoking and/or burning, etc.
 • This catalog has only typical specifications. Therefore, please approve our product specifications or transact the approval sheet for product specifications before ordering.

LQM21FN_80 Series 0805/2012 (inch/mm)

Large Current, Low DC Resistance Type

Appearance/Dimensions

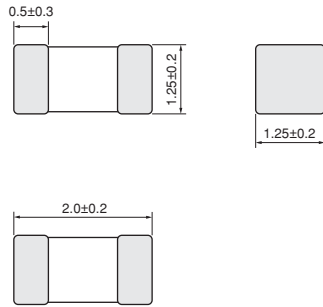

(in mm)

Packaging

Code	Packaging	Minimum Quantity
L	ø180mm Embossed Taping	3000
K	ø330mm Embossed Taping	10000
B	Packing in Bulk	1000



Refer to pages 102 to 106 for mounting information.

Rated Value (□: packaging code)

Part Number	Inductance	Inductance Test Frequency	Rated Current	DC Resistance	Self-Resonance Frequency (min.)	
LQM21FN4R7M80□	4.7μH ±20%	1MHz	120mA	0.18 Ω ±30%	25MHz	Kit
LQM21FN100M80□	10μH ±20%	1MHz	100mA	0.30 Ω ±30%	15MHz	Kit

Class of Magnetic Shield: Magnetic shield of ferrite
 Operating Temperature Range (Self-temperature rise is not included): -55°C~+125°C

Impedance-Frequency Characteristics (Typ.)

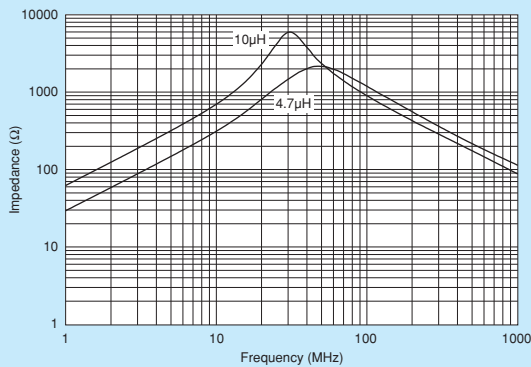

Inductance-Current Characteristics (Typ.)

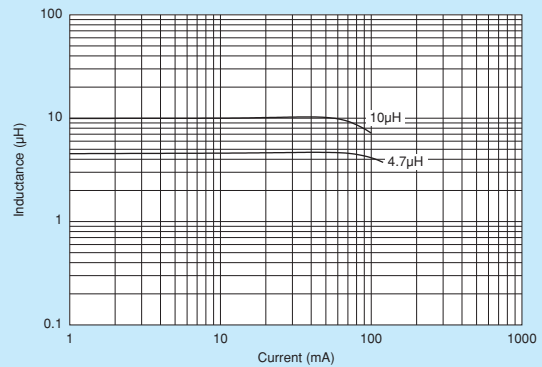

Note • Please read rating and CAUTION (for storage, operating, rating, soldering, mounting and handling) in this catalog to prevent smoking and/or burning, etc.
 • This catalog has only typical specifications. Therefore, please approve our product specifications or transact the approval sheet for product specifications before ordering.

LQW15CN_00 Series 0402/1005 (inch/mm)

For Voltage Conversion

Appearance/Dimensions

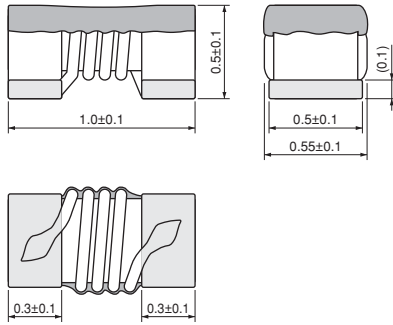

(in mm)

Packaging

Code	Packaging	Minimum Quantity
D	ø180mm Paper Taping	10000
B	Packing in Bulk	500



Refer to pages 102 to 106 for mounting information.

Rated Value (□: packaging code)

Part Number	Inductance	Inductance Test Frequency	Rated Current	Max. of DC Resistance	Self-Resonance Frequency (min.)	
LQW15CN18NJ00□	18nH ±5%	100MHz	1400mA	0.046Ω	3000MHz	Kit
LQW15CN33NJ00□	33nH ±5%	100MHz	1300mA	0.065Ω	1800MHz	Kit
LQW15CN48NJ00□	48nH ±5%	100MHz	1100mA	0.078Ω	1400MHz	Kit
LQW15CN70NJ00□	70nH ±5%	100MHz	820mA	0.12Ω	1300MHz	Kit
LQW15CN96NJ00□	96nH ±5%	100MHz	730mA	0.16Ω	1100MHz	Kit
LQW15CNR13J00□	130nH ±5%	100MHz	640mA	0.23Ω	1000MHz	Kit
LQW15CNR16J00□	160nH ±5%	100MHz	480mA	0.33Ω	900MHz	Kit
LQW15CNR20J00□	200nH ±5%	100MHz	390mA	0.47Ω	800MHz	Kit

Class of Magnetic Shield: No magnetic shield

Operating Temperature Range (Self-temperature rise is included): -55°C~+135°C

Operating Temperature Range (Self-temperature rise is not included): -55°C~+125°C

For reflow soldering only.

Impedance-Frequency Characteristics (Typ.)

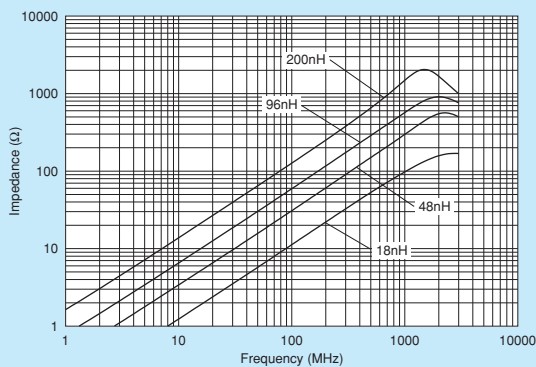

Inductance-Current Characteristics (Typ.)

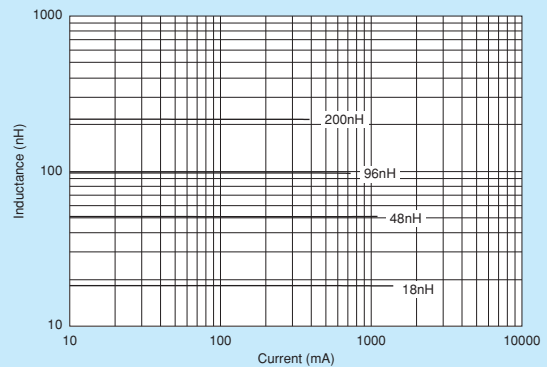

Derating of Rated Current

In operating temperature exceeding +85°C, derating of current is necessary for LQW15C series.

Please apply the derating curve shown in chart according to the operating temperature.

Derating of Rated Current

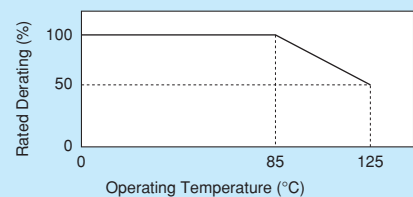

Note • Please read rating and CAUTION (for storage, operating, rating, soldering, mounting and handling) in this catalog to prevent smoking and/or burning, etc.
• This catalog has only typical specifications. Therefore, please approve our product specifications or transact the approval sheet for product specifications before ordering.

LQW15CN_10 Series 0402/1005 (inch/mm)

For RF Choke, Voltage Conversion

■ Appearance/Dimensions

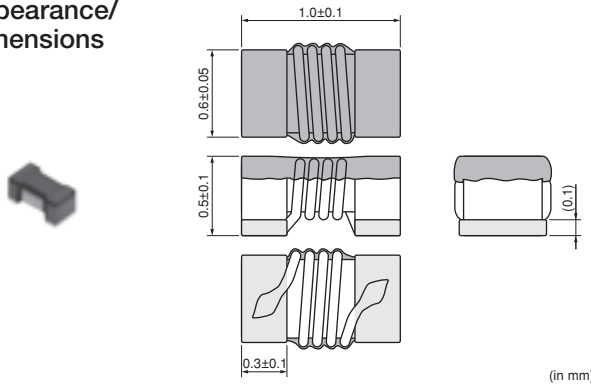

■ Packaging

Code	Packaging	Minimum Quantity
D	ø180mm Paper Taping	10000
B	Packing in Bulk	500



Refer to pages 102 to 106 for mounting information.

■ Rated Value (□: packaging code)

Part Number	Inductance	Inductance Test Frequency	Rated Current	Max. of DC Resistance	Self-Resonance Frequency (min.)	
LQW15CNR22J10□	220nH ±5%	100MHz	450mA	0.47Ω	1400MHz	New
LQW15CNR22K10□	220nH ±10%	100MHz	450mA	0.47Ω	1400MHz	New
LQW15CNR27J10□	270nH ±5%	100MHz	420mA	0.52Ω	830MHz	New
LQW15CNR27K10□	270nH ±10%	100MHz	420mA	0.52Ω	830MHz	New
LQW15CNR33J10□	330nH ±5%	100MHz	390mA	0.56Ω	520MHz	New
LQW15CNR33K10□	330nH ±10%	100MHz	390mA	0.56Ω	520MHz	New
LQW15CNR39J10□	390nH ±5%	100MHz	370mA	0.62Ω	450MHz	New
LQW15CNR39K10□	390nH ±10%	100MHz	370mA	0.62Ω	450MHz	Kit
LQW15CNR42J10□	420nH ±5%	10MHz	370mA	0.62Ω	400MHz	New
LQW15CNR42K10□	420nH ±10%	10MHz	370mA	0.62Ω	400MHz	New
LQW15CNR47J10□	470nH ±5%	10MHz	350mA	0.66Ω	380MHz	New
LQW15CNR47K10□	470nH ±10%	10MHz	350mA	0.66Ω	380MHz	New
LQW15CNR56J10□	560nH ±5%	10MHz	300mA	0.71Ω	300MHz	New
LQW15CNR56K10□	560nH ±10%	10MHz	300mA	0.71Ω	300MHz	Kit

Class of Magnetic Shield: No magnetic shield
 Operating Temperature Range (Self-temperature rise is not included): -55°C~+125°C
 For reflow soldering only.

■ Impedance-Frequency Characteristics (Typ.)

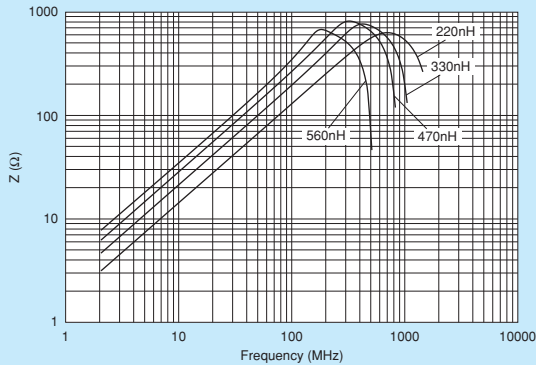

■ Inductance-Current Characteristics (Typ.)

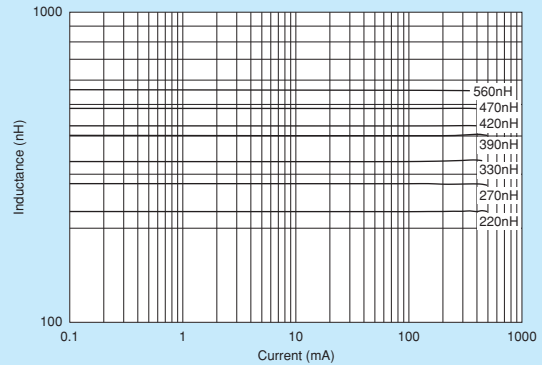

Continued on the following page.

△Note • Please read rating and △CAUTION (for storage, operating, rating, soldering, mounting and handling) in this catalog to prevent smoking and/or burning, etc.
 • This catalog has only typical specifications. Therefore, please approve our product specifications or transact the approval sheet for product specifications before ordering.

■ Derating of Rated Current

In operating temperature exceeding +85°C, derating of current is necessary for LQW15C series.

Please apply the derating curve shown in chart according to the operating temperature.

Derating of Rated Current

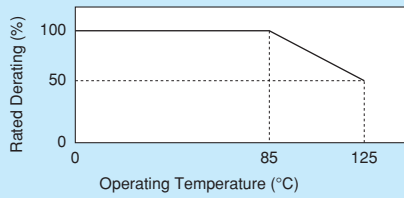

LQW18CN_00 Series 0603/1608 (inch/mm)

for FM/TV Band Choke

Appearance/Dimensions

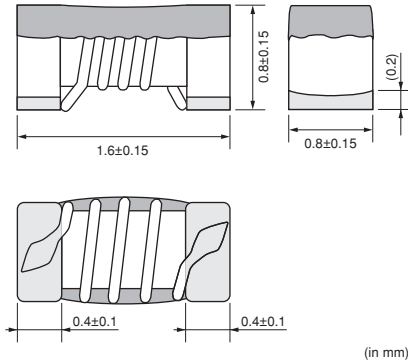

Packaging

Code	Packaging	Minimum Quantity
D	ø180mm Paper Taping	4000
B	Packing in Bulk	500



Refer to pages 102 to 106 for mounting information.

Rated Value (□: packaging code)

Part Number	Inductance	Inductance Test Frequency	Rated Current	Max. of DC Resistance	Self-Resonance Frequency (min.)	
LQW18CN4N9D00□	4.9nH ±0.5nH	10MHz	2600mA	0.015Ω	2300MHz	Kit
LQW18CN15NJ00□	15nH ±5%	10MHz	2200mA	0.025Ω	2000MHz	Kit
LQW18CN33NJ00□	33nH ±5%	10MHz	1700mA	0.035Ω	1800MHz	Kit
LQW18CN55NJ00□	55nH ±5%	10MHz	1500mA	0.045Ω	1600MHz	Kit
LQW18CN85NJ00□	85nH ±5%	10MHz	1400mA	0.060Ω	1380MHz	Kit
LQW18CNR10K00□	100nH ±10%	10MHz	1000mA	0.10Ω	1260MHz	Kit
LQW18CNR12J00□	120nH ±5%	10MHz	1100mA	0.085Ω	1200MHz	Kit
LQW18CNR16J00□	160nH ±5%	10MHz	1000mA	0.10Ω	900MHz	Kit
LQW18CNR21J00□	210nH ±5%	10MHz	800mA	0.15Ω	720MHz	Kit
LQW18CNR27J00□	270nH ±5%	10MHz	750mA	0.16Ω	660MHz	Kit
LQW18CNR33J00□	330nH ±5%	10MHz	630mA	0.25Ω	600MHz	Kit
LQW18CNR39J00□	390nH ±5%	10MHz	620mA	0.28Ω	570MHz	Kit
LQW18CNR47J00□	470nH ±5%	10MHz	500mA	0.45Ω	555MHz	Kit
LQW18CNR56J00□	560nH ±5%	10MHz	450mA	0.48Ω	540MHz	Kit
LQW18CNR65J00□	650nH ±5%	10MHz	430mA	0.52Ω	510MHz	Kit

Class of Magnetic Shield: No magnetic shield
 Operating Temperature Range (Self-temperature rise is not included): -40°C~+85°C
 For reflow soldering only.

Impedance-Frequency Characteristics (Typ.)

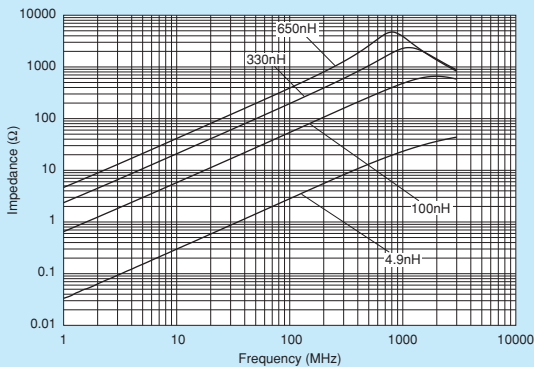

Inductance-Current Characteristics (Typ.)

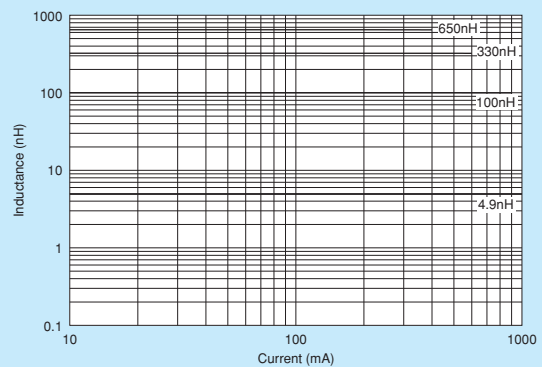

Note • Please read rating and CAUTION (for storage, operating, rating, soldering, mounting and handling) in this catalog to prevent smoking and/or burning, etc.
 • This catalog has only typical specifications. Therefore, please approve our product specifications or transact the approval sheet for product specifications before ordering.

LQH31CN_03 Series 1206/3216 (inch/mm)

Size Code 1206 (3216) in inch (in mm)

Appearance/Dimensions

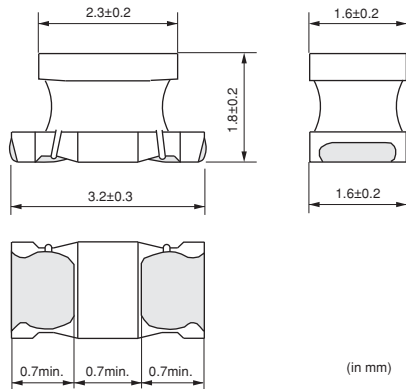

(in mm)

Packaging

Code	Packaging	Minimum Quantity
L	ø180mm Embossed Taping	2000
K	ø330mm Embossed Taping	7500



Refer to pages 102 to 106 for mounting information.

Rated Value (□: packaging code)

Part Number	Inductance	Inductance Test Frequency	Rated Current ^{*1}	DC Resistance	Self-Resonance Frequency (min.)
LQH31CNR12M03□	0.12μH ±20%	1MHz	970mA	0.08Ω ±40%	250MHz
LQH31CNR22M03□	0.22μH ±20%	1MHz	850mA	0.1Ω ±40%	250MHz
LQH31CNR47M03□	0.47μH ±20%	1MHz	700mA	0.15Ω ±40%	180MHz
LQH31CN1R0M03□	1.0μH ±20%	1MHz	510mA	0.28Ω ±30%	100MHz
LQH31CN2R2M03□	2.2μH ±20%	1MHz	430mA	0.41Ω ±30%	50MHz
LQH31CN4R7M03□	4.7μH ±20%	1MHz	340mA	0.65Ω ±30%	31MHz
LQH31CN100K03□	10μH ±10%	1MHz	230mA	1.3Ω ±30%	20MHz
LQH31CN220K03□	22μH ±10%	1MHz	160mA	3.0Ω ±30%	14MHz
LQH31CN470K03□	47μH ±10%	1MHz	100mA	8.0Ω ±30%	10MHz
LQH31CN101K03□	100μH ±10%	1MHz	80mA	12.0Ω ±30%	7MHz

Class of Magnetic Shield: No magnetic shield

Operating Temperature Range (Self-temperature rise is not included): -40°C~+85°C

*1 When applied rated current to the products, self-temperature rise shall be limited to 35°C max. and inductance will be within ±10% of initial inductance value.

Impedance-Frequency Characteristics (Typ.)

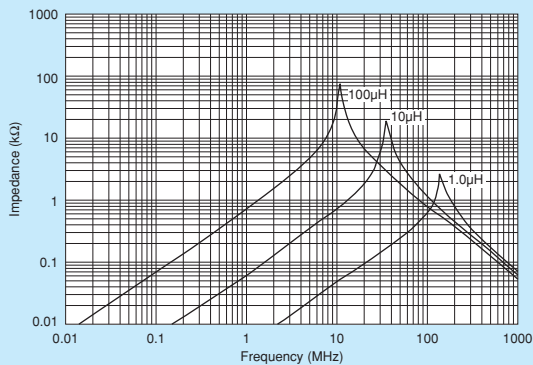

Inductance-Current Characteristics (Typ.)

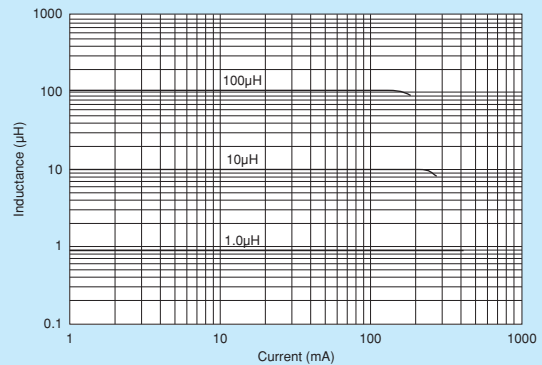

△Note • Please read rating and △CAUTION (for storage, operating, rating, soldering, mounting and handling) in this catalog to prevent smoking and/or burning, etc.
• This catalog has only typical specifications. Therefore, please approve our product specifications or transact the approval sheet for product specifications before ordering.

LQH32CN_23/LQH32CN_33 Series 1210/3225 (inch/mm)

Size Code 1210 (3225) in inch (in mm)

Appearance/Dimensions

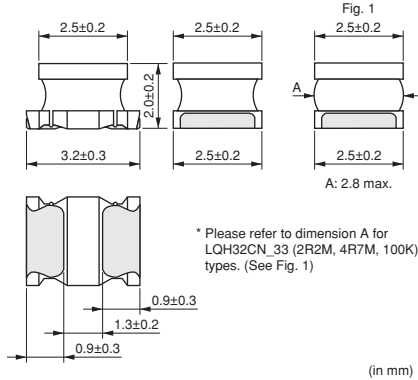

Packaging

Code	Packaging	Minimum Quantity
L	ø180mm Embossed Taping	2000
K	ø330mm Embossed Taping	7500



Refer to pages 102 to 106 for mounting information.

Rated Value (□: packaging code)

Part Number	Inductance	Inductance Test Frequency	Rated Current ^{*1}	DC Resistance	Self-Resonance Frequency (min.)	
LQH32CN1R0M23□	1.0μH ±20%	1MHz	800mA	0.09Ω ±30%	96MHz	Kit
LQH32CN2R2M23□	2.2μH ±20%	1MHz	600mA	0.13Ω ±30%	64MHz	Kit
LQH32CN4R7M23□	4.7μH ±20%	1MHz	450mA	0.2Ω ±30%	43MHz	Kit
LQH32CN100K23□	10μH ±10%	1MHz	300mA	0.44Ω ±30%	26MHz	Kit
LQH32CN220K23□	22μH ±10%	1MHz	250mA	0.71Ω ±30%	19MHz	Kit
LQH32CN470K23□	47μH ±10%	1MHz	170mA	1.3Ω ±30%	15MHz	Kit
LQH32CN101K23□	100μH ±10%	1MHz	100mA	3.5Ω ±30%	10MHz	Kit
LQH32CN221K23□	220μH ±10%	1MHz	70mA	8.4Ω ±30%	6.8MHz	Kit
LQH32CN331K23□	330μH ±10%	1MHz	60mA	10.0Ω ±30%	5.6MHz	Kit
LQH32CN391K23□	390μH ±10%	1MHz	60mA	17Ω ±30%	5MHz	Kit
LQH32CN471K23□	470μH ±10%	1kHz	60mA	19Ω ±30%	5MHz	Kit
LQH32CN561K23□	560μH ±10%	1kHz	60mA	22.0Ω ±30%	5MHz	Kit
LQH32CNR15M33□	0.15μH ±20%	1MHz	1450mA	0.028Ω ±30%	400MHz	Kit
LQH32CNR27M33□	0.27μH ±20%	1MHz	1250mA	0.034Ω ±30%	250MHz	Kit
LQH32CNR47M33□	0.47μH ±20%	1MHz	1100mA	0.042Ω ±30%	150MHz	Kit
LQH32CN1R0M33□	1.0μH ±20%	1MHz	1000mA	0.06Ω ±30%	100MHz	Kit
LQH32CN2R2M33□	2.2μH ±20%	1MHz	790mA	0.097Ω ±30%	64MHz	Kit
LQH32CN4R7M33□	4.7μH ±20%	1MHz	650mA	0.15Ω ±30%	43MHz	Kit
LQH32CN100K33□	10μH ±10%	1MHz	450mA	0.3Ω ±30%	26MHz	Kit

Class of Magnetic Shield: No magnetic shield

Operating Temperature Range (Self-temperature rise is not included): -40°C~+85°C

*1 When applied rated current to the products, self-temperature rise shall be limited to 20°C max. and inductance will be within ±10% of initial inductance value.

Continued on the following page.

[△]Note • Please read rating and [△]CAUTION (for storage, operating, rating, soldering, mounting and handling) in this catalog to prevent smoking and/or burning, etc.
• This catalog has only typical specifications. Therefore, please approve our product specifications or transact the approval sheet for product specifications before ordering.

■ Impedance-Frequency Characteristics (Typ.)

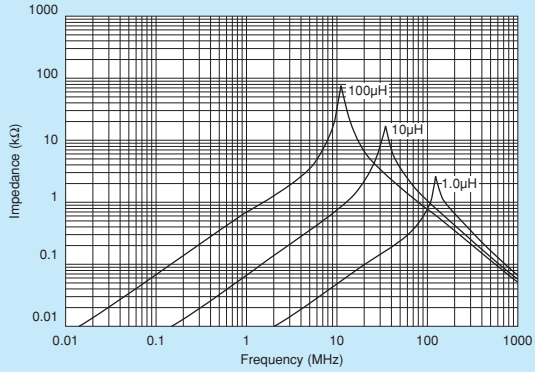

■ Inductance-Current Characteristics (Typ.)

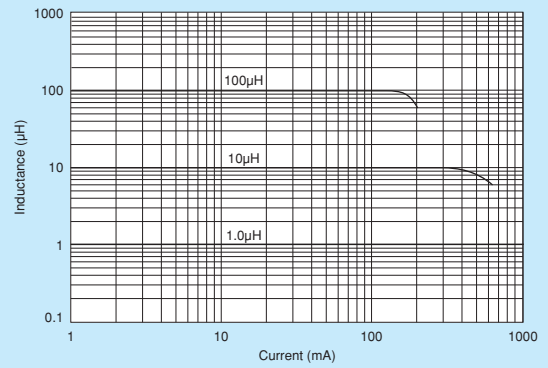

⚠Note • Please read rating and ⚠CAUTION (for storage, operating, rating, soldering, mounting and handling) in this catalog to prevent smoking and/or burning, etc.
• This catalog has only typical specifications. Therefore, please approve our product specifications or transact the approval sheet for product specifications before ordering.

LQH32CN_53 Series 1210/3225 (inch/mm)

Size Code 1210 (3225) in inch (in mm)

Appearance/Dimensions

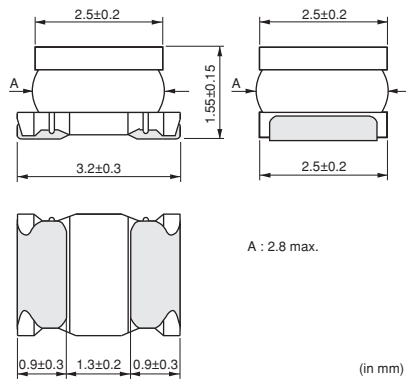

Packaging

Code	Packaging	Minimum Quantity
L	ø180mm Embossed Taping	2000
K	ø330mm Embossed Taping	7500



Refer to pages 102 to 106 for mounting information.

Rated Value (□: packaging code)

Part Number	Inductance	Inductance Test Frequency	Rated Current ^{*1}	DC Resistance	Self-Resonance Frequency (min.)	
LQH32CN1R0M53□	1.0µH ±20%	1MHz	1000mA	0.060Ω ±30%	100MHz	Kit
LQH32CN2R2M53□	2.2µH ±20%	1MHz	790mA	0.097Ω ±30%	64MHz	Kit
LQH32CN3R3M53□	3.3µH ±20%	1MHz	710mA	0.12Ω ±30%	50MHz	
LQH32CN4R7M53□	4.7µH ±20%	1MHz	650mA	0.15Ω ±30%	43MHz	Kit
LQH32CN6R8M53□	6.8µH ±20%	1MHz	540mA	0.25Ω ±30%	32MHz	
LQH32CN100K53□	10µH ±10%	1MHz	450mA	0.30Ω ±30%	26MHz	Kit
LQH32CN150K53□	15µH ±10%	1MHz	300mA	0.58Ω ±30%	26MHz	Kit
LQH32CN220K53□	22µH ±10%	1MHz	250mA	0.71Ω ±30%	19MHz	Kit
LQH32CN330K53□	33µH ±10%	1MHz	200mA	1.1Ω ±30%	17MHz	Kit
LQH32CN470K53□	47µH ±10%	1MHz	170mA	1.3Ω ±30%	15MHz	Kit
LQH32CN680K53□	68µH ±10%	1MHz	130mA	2.2Ω ±30%	12MHz	Kit
LQH32CN101K53□	100µH ±10%	1MHz	100mA	3.5Ω ±30%	10MHz	Kit

Class of Magnetic Shield: No magnetic shield

Operating Temperature Range (Self-temperature rise is not included): -40°C~+85°C

*1 When applied rated current to the products, self-temperature rise shall be limited to 20°C max. and inductance will be within ±10% of initial inductance value.

Impedance-Frequency Characteristics (Typ.)

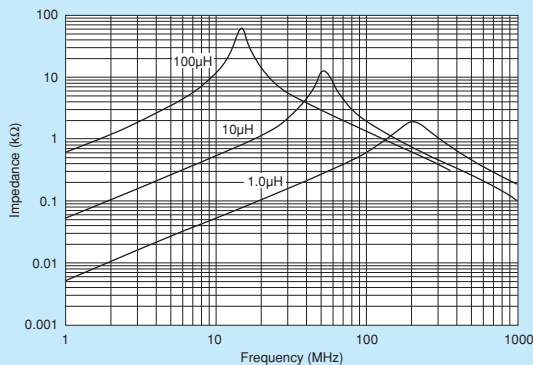

Inductance-Current Characteristics (Typ.)

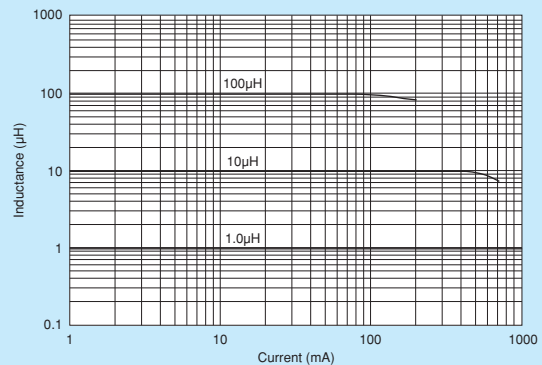

△Note • Please read rating and △CAUTION (for storage, operating, rating, soldering, mounting and handling) in this catalog to prevent smoking and/or burning, etc.
• This catalog has only typical specifications. Therefore, please approve our product specifications or transact the approval sheet for product specifications before ordering.

LQH43CN_03 Series 1812/4532 (inch/mm)

Size Code 1812 (4532) in inch (in mm)

Appearance/Dimensions

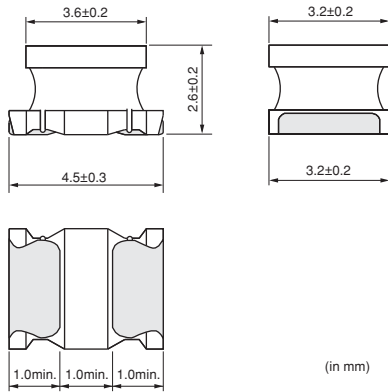

Packaging

Code	Packaging	Minimum Quantity
L	ø180mm Embossed Taping	500



Refer to pages 102 to 106 for mounting information.

Rated Value (□: packaging code)

Part Number	Inductance	Inductance Test Frequency	Rated Current ^{*1}	Max. of DC Resistance	Self-Resonance Frequency (min.)	
LQH43CN1R0M03□	1.0μH ±20%	1MHz	1080mA	0.08Ω	100MHz	Kit
LQH43CN1R5M03□	1.5μH ±20%	1MHz	1000mA	0.09Ω	85MHz	Kit
LQH43CN2R2M03□	2.2μH ±20%	1MHz	900mA	0.11Ω	60MHz	Kit
LQH43CN3R3M03□	3.3μH ±20%	1MHz	800mA	0.13Ω	47MHz	Kit
LQH43CN4R7M03□	4.7μH ±20%	1MHz	750mA	0.15Ω	35MHz	Kit
LQH43CN6R8M03□	6.8μH ±20%	1MHz	720mA	0.20Ω	30MHz	Kit
LQH43CN100K03□	10μH ±10%	1MHz	650mA	0.24Ω	23MHz	Kit
LQH43CN150K03□	15μH ±10%	1MHz	570mA	0.32Ω	20MHz	Kit
LQH43CN220K03□	22μH ±10%	1MHz	420mA	0.6Ω	15MHz	Kit
LQH43CN330K03□	33μH ±10%	1MHz	310mA	1.0Ω	12MHz	Kit
LQH43CN470K03□	47μH ±10%	1MHz	280mA	1.1Ω	10MHz	Kit
LQH43CN680K03□	68μH ±10%	1MHz	220mA	1.7Ω	8.4MHz	Kit
LQH43CN101K03□	100μH ±10%	1MHz	190mA	2.2Ω	6.8MHz	Kit
LQH43CN151K03□	150μH ±10%	1MHz	130mA	3.5Ω	5.5MHz	Kit
LQH43CN221K03□	220μH ±10%	1MHz	110mA	4.0Ω	4.5MHz	Kit
LQH43CN331K03□	330μH ±10%	1MHz	100mA	6.8Ω	3.6MHz	Kit
LQH43CN471K03□	470μH ±10%	1kHz	90mA	8.5Ω	3.0MHz	Kit

Class of Magnetic Shield: No magnetic shield

Operating Temperature Range (Self-temperature rise is not included): -40°C~+85°C

*1 When applied rated current to the products, self-temperature rise shall be limited to 20°C max. and inductance will be within ±10% of initial inductance value.

Impedance-Frequency Characteristics (Typ.)

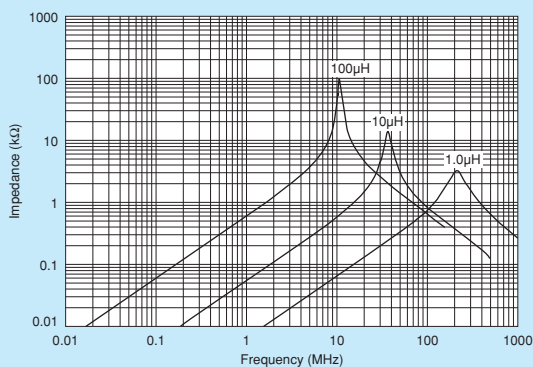

Inductance-Current Characteristics (Typ.)

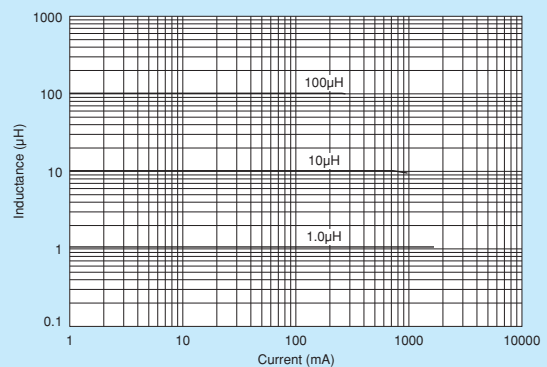

△Note • Please read rating and △CAUTION (for storage, operating, rating, soldering, mounting and handling) in this catalog to prevent smoking and/or burning, etc.
• This catalog has only typical specifications. Therefore, please approve our product specifications or transact the approval sheet for product specifications before ordering.

LQH43CN_33 Series 1812/4532 (inch/mm)

Low DC Resistance Type

Appearance/Dimensions

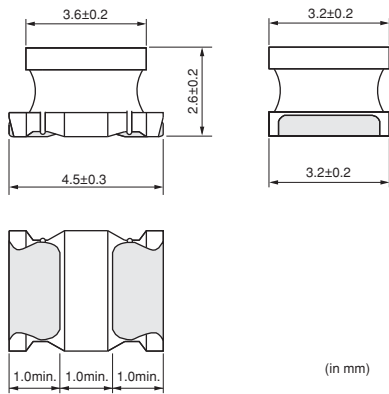

Packaging

Code	Packaging	Minimum Quantity
L	ø180mm Embossed Taping	500



Refer to pages 102 to 106 for mounting information.

Rated Value (□: packaging code)

Part Number	Inductance	Inductance Test Frequency	Rated Current ^{*1}	DC Resistance	Self-Resonance Frequency (min.)	
LQH43CNR56M33□	0.56μH ±20%	1MHz	2950mA	0.023Ω ±30%	160MHz	Kit
LQH43CNR82M33□	0.82μH ±20%	1MHz	2800mA	0.027Ω ±30%	130MHz	Kit
LQH43CN1R0M33□	1.0μH ±20%	1MHz	2600mA	0.032Ω ±30%	110MHz	Kit
LQH43CN1R5M33□	1.5μH ±20%	1MHz	2450mA	0.036Ω ±30%	80MHz	Kit
LQH43CN1R8M33□	1.8μH ±20%	1MHz	2300mA	0.042Ω ±30%	70MHz	Kit
LQH43CN2R2M33□	2.2μH ±20%	1MHz	2100mA	0.047Ω ±30%	60MHz	Kit
LQH43CN2R7M33□	2.7μH ±20%	1MHz	1800mA	0.053Ω ±30%	50MHz	Kit
LQH43CN3R3M33□	3.3μH ±20%	1MHz	1650mA	0.076Ω ±30%	47MHz	Kit
LQH43CN3R9M33□	3.9μH ±20%	1MHz	1600mA	0.082Ω ±30%	40MHz	Kit

Class of Magnetic Shield: No magnetic shield

Operating Temperature Range (Self-temperature rise is not included): -40°C~+85°C

*1 When applied rated current to the products, self-temperature rise shall be limited to 40°C max. and inductance will be within ±20% of initial inductance value.

Impedance-Frequency Characteristics (Typ.)

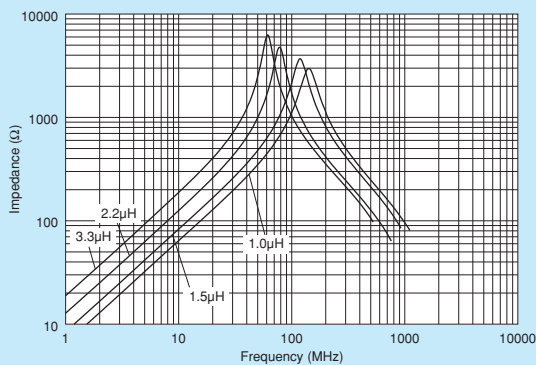

Inductance-Current Characteristics (Typ.)

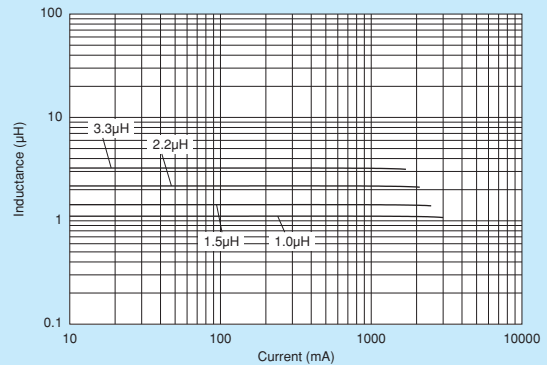

△Note • Please read rating and △CAUTION (for storage, operating, rating, soldering, mounting and handling) in this catalog to prevent smoking and/or burning, etc.
• This catalog has only typical specifications. Therefore, please approve our product specifications or transact the approval sheet for product specifications before ordering.

LQH55DN_03 Series 2220/5750 (inch/mm)

Large Current

Appearance/Dimensions

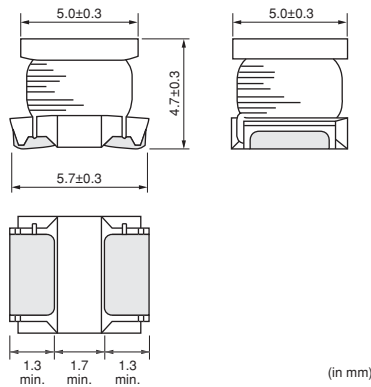

Packaging

Code	Packaging	Minimum Quantity
L	ø180mm Embossed Taping	350
K	ø330mm Embossed Taping	1500



Refer to pages 102 to 106 for mounting information.

Rated Value (□: packaging code)

Part Number	Inductance	Inductance Test Frequency	Rated Current ^{*1}	DC Resistance	Self-Resonance Frequency (min.)
LQH55DNR12M03□	0.12μH ±20%	1MHz	6000mA	0.007Ω ±40%	450MHz
LQH55DNR27M03□	0.27μH ±20%	1MHz	5300mA	0.010Ω ±40%	300MHz
LQH55DNR47M03□	0.47μH ±20%	1MHz	4800mA	0.013Ω ±40%	200MHz
LQH55DN1R0M03□	1.0μH ±20%	1MHz	4000mA	0.019Ω ±40%	150MHz
LQH55DN1R5M03□	1.5μH ±20%	1MHz	3700mA	0.022Ω ±40%	110MHz
LQH55DN2R2M03□	2.2μH ±20%	1MHz	3200mA	0.029Ω ±40%	80MHz
LQH55DN3R3M03□	3.3μH ±20%	1MHz	2900mA	0.036Ω ±40%	40MHz
LQH55DN4R7M03□	4.7μH ±20%	1MHz	2700mA	0.041Ω ±40%	30MHz
LQH55DN6R8M03□	6.8μH ±20%	1MHz	2000mA	0.074Ω ±40%	25MHz
LQH55DN100M03□	10μH ±20%	1MHz	1700mA	0.093Ω ±40%	20MHz
LQH55DN150M03□	15μH ±20%	1MHz	1400mA	0.15Ω ±40%	17MHz
LQH55DN220M03□	22μH ±20%	1MHz	1200mA	0.19Ω ±40%	15MHz
LQH55DN330M03□	33μH ±20%	1MHz	900mA	0.32Ω ±40%	12MHz
LQH55DN470M03□	47μH ±20%	1MHz	800mA	0.40Ω ±40%	10MHz
LQH55DN680M03□	68μH ±20%	1MHz	640mA	0.67Ω ±40%	7.6MHz
LQH55DN101M03□	100μH ±20%	100kHz	560mA	0.86Ω ±40%	6.5MHz
LQH55DN151M03□	150μH ±20%	100kHz	420mA	1.9Ω ±40%	5.0MHz
LQH55DN221M03□	220μH ±20%	100kHz	320mA	2.4Ω ±40%	4.0MHz
LQH55DN331M03□	330μH ±20%	100kHz	270mA	4.4Ω ±40%	3.1MHz
LQH55DN471M03□	470μH ±20%	100kHz	240mA	5.4Ω ±40%	2.4MHz
LQH55DN681M03□	680μH ±20%	100kHz	190mA	8.1Ω ±40%	1.9MHz
LQH55DN102M03□	1000μH ±20%	10kHz	150mA	10.3Ω ±40%	1.7MHz
LQH55DN222M03□	2200μH ±20%	10kHz	100mA	21.5Ω ±40%	1.2MHz
LQH55DN472M03□	4700μH ±20%	10kHz	70mA	43.6Ω ±40%	0.8MHz
LQH55DN103M03□	10000μH ±20%	10kHz	50mA	100Ω ±40%	0.5MHz

Class of Magnetic Shield: No magnetic shield

Operating Temperature Range (Self-temperature rise is not included): -40°C~+80°C

For reflow soldering only.

*1 When applied rated current to the products, self-temperature rise shall be limited to 40°C max. and inductance will be within ±40% of initial inductance value.

Continued on the following page.

[△]Note • Please read rating and [△]CAUTION (for storage, operating, rating, soldering, mounting and handling) in this catalog to prevent smoking and/or burning, etc.
• This catalog has only typical specifications. Therefore, please approve our product specifications or transact the approval sheet for product specifications before ordering.

■ Impedance-Frequency Characteristics (Typ.)

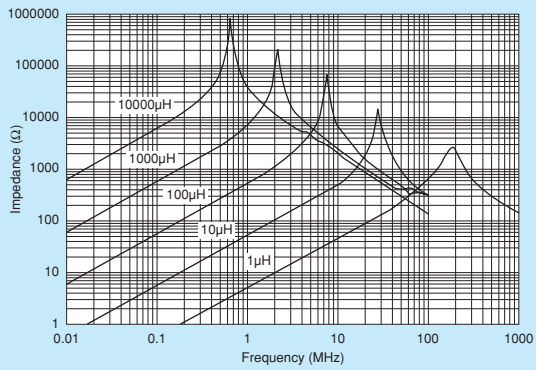

■ Inductance-Current Characteristics (Typ.)

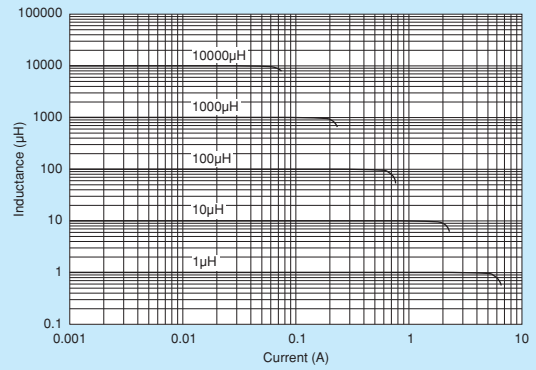

⚠Note • Please read rating and ⚠CAUTION (for storage, operating, rating, soldering, mounting and handling) in this catalog to prevent smoking and/or burning, etc.
• This catalog has only typical specifications. Therefore, please approve our product specifications or transact the approval sheet for product specifications before ordering.

LQH66SN_03 Series 2525/6363 (inch/mm)

Closed Magnetic Circuit

Appearance/Dimensions

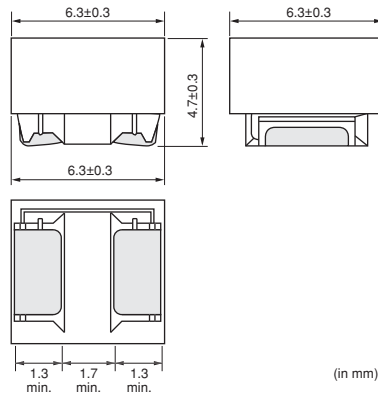

Packaging

Code	Packaging	Minimum Quantity
L	ø180mm Embossed Taping	350
K	ø330mm Embossed Taping	1500



Refer to pages 102 to 106 for mounting information.

Rated Value (□: packaging code)

Part Number	Inductance	Inductance Test Frequency	Rated Current ^{*1}	DC Resistance	Self-Resonance Frequency (min.)
LQH66SNR27M03□	0.27μH ±20%	1MHz	6000mA	0.007Ω ±40%	300MHz
LQH66SNR68M03□	0.68μH ±20%	1MHz	5300mA	0.010Ω ±40%	180MHz
LQH66SN1R0M03□	1.0μH ±20%	1MHz	4700mA	0.013Ω ±40%	150MHz
LQH66SN1R5M03□	1.5μH ±20%	1MHz	3800mA	0.016Ω ±40%	110MHz
LQH66SN2R2M03□	2.2μH ±20%	1MHz	3300mA	0.019Ω ±40%	80MHz
LQH66SN3R3M03□	3.3μH ±20%	1MHz	2600mA	0.022Ω ±40%	40MHz
LQH66SN4R7M03□	4.7μH ±20%	1MHz	2200mA	0.025Ω ±40%	30MHz
LQH66SN6R8M03□	6.8μH ±20%	1MHz	1800mA	0.029Ω ±40%	25MHz
LQH66SN100M03□	10μH ±20%	1MHz	1600mA	0.036Ω ±40%	20MHz
LQH66SN150M03□	15μH ±20%	1MHz	1300mA	0.069Ω ±40%	17MHz
LQH66SN220M03□	22μH ±20%	1MHz	1100mA	0.087Ω ±40%	15MHz
LQH66SN330M03□	33μH ±20%	1MHz	860mA	0.14Ω ±40%	12MHz
LQH66SN470M03□	47μH ±20%	1MHz	760mA	0.17Ω ±40%	10MHz
LQH66SN680M03□	68μH ±20%	1MHz	600mA	0.29Ω ±40%	7.6MHz
LQH66SN101M03□	100μH ±20%	100kHz	520mA	0.36Ω ±40%	6.5MHz
LQH66SN151M03□	150μH ±20%	100kHz	420mA	0.63Ω ±40%	5.0MHz
LQH66SN221M03□	220μH ±20%	100kHz	350mA	0.79Ω ±40%	4.0MHz
LQH66SN331M03□	330μH ±20%	100kHz	280mA	1.8Ω ±40%	3.2MHz
LQH66SN471M03□	470μH ±20%	100kHz	240mA	2.2Ω ±40%	2.5MHz
LQH66SN681M03□	680μH ±20%	100kHz	200mA	3.9Ω ±40%	2.0MHz
LQH66SN102M03□	1000μH ±20%	10kHz	160mA	4.9Ω ±40%	1.7MHz
LQH66SN222M03□	2200μH ±20%	10kHz	100mA	9.4Ω ±40%	1.2MHz
LQH66SN472M03□	4700μH ±20%	10kHz	70mA	19.5Ω ±40%	0.8MHz
LQH66SN103M03□	10000μH ±20%	10kHz	50mA	39.7Ω ±40%	0.5MHz

Class of Magnetic Shield: Magnetic shield of ferrite

Operating Temperature Range (Self-temperature rise is not included): -40°C~+80°C

For reflow soldering only.

*1 When applied rated current to the products, self-temperature rise shall be limited to 40°C max. and inductance will be within ±40% of initial inductance value.

Continued on the following page.

■ Impedance-Frequency Characteristics (Typ.)

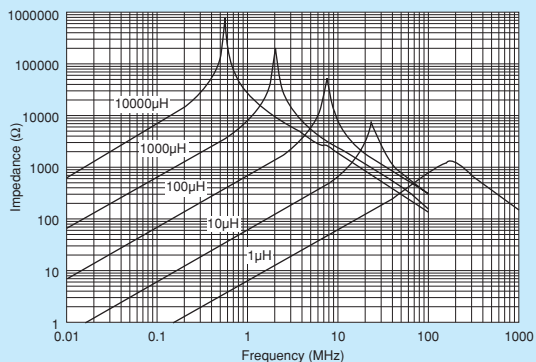

■ Inductance-Current Characteristics (Typ.)

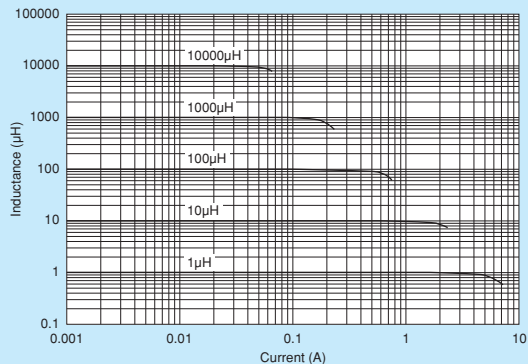

Wire Wound Type (Ferrite Core)
Inductors for Power Lines

Inductors for General Use

RF Inductors

⚠Note • Please read rating and ⚠CAUTION (for storage, operating, rating, soldering, mounting and handling) in this catalog to prevent smoking and/or burning, etc.
• This catalog has only typical specifications. Therefore, please approve our product specifications or transact the approval sheet for product specifications before ordering.

⚠ Caution

● Rating

1. About the Rated Current

Do not use products beyond the rated current as this may create excessive heat and deteriorate the insulation resistance.

2. About Excessive Surge Current

Surge current (pulse current or rush current) greater than the specified rated current applied to the product may cause a critical failure, such as an open circuit, burnout caused by excessive temperature rise. Please contact us in advance in case of applying the surge current.

Notice

● Storage and Operating Condition

<Operating Environment>

Do not use products in chemical atmosphere such as chlorine gas, acid or sulfide gas.

<Storage Requirements>

1. Storage Period

LQM series should be used within 6 months; the other products should be used within 12 months. Check solderability if this period is exceeded.

2. Storage Conditions

(1) Store products in a warehouse in compliance with the following conditions:

Temperature: -10 to +40°C.

Humidity: 15 to 85% (relative humidity)

Do not subject products to rapid changes in temperature and humidity.

Do not store them in chemical atmosphere such as one containing sulfuric acid gas or alkaline gas.

This will prevent electrode oxidation, which causes poor solderability and possible corrosion of inductors.

(2) Do not store products in bulk packaging to prevent collision among inductors, which causes core chipping and wire breakage.

(3) Store products on pallets to protect from humidity, dust, etc.

(4) Avoid heat shock, vibration, direct sunlight, etc.

● Handling

This item is designed to have sufficient strength, but handle with care to avoid chipping or breaking its ceramic structure.

LQW_C series

- To prevent breaking the wire, avoid touching with sharp material, such as tweezers or other material such as bristles of cleaning brush, to the wire wound portion.
- To prevent breaking the core, avoid applying excessive mechanical shock to products mounted on the board.
- In some mounting machines, when picking up components, a support pin pushes the components up from the bottom of the base tape. In this case, please remove the support pin. The support pin may damage the components and break the wire.

- In rare cases, the laser recognition cannot recognize this component. Please contact us when you use laser recognition. (There is no problem with the permeation and reflection type.)
- The product temperature rises about 40°C maximum when the permissible current is applied to LQW15C/LQW18C. Please take care for the temperature of the substrate and air around the part.

LQH_C/D/H/M/N/P series

- To prevent breaking the wire, avoid touching with sharp material, such as tweezers or the bristles of a cleaning brush, to the wire wound portion of this product.
- To prevent breaking the core, avoid applying excessive mechanical shock to products mounted on the board.
- Temperature may rise up to max. 40°C when applying the rated current to Inductors for Power Lines. Be careful of the temperature rating of the circuit board and components around the chip Inductors.

LQM series

- There is the possibility that magnetism may change the inductance value. Do not use a magnet or tweezers with magnetism when handling chip inductors. (The tip of the tweezers should be molded with resin or pottery.)
- When the excessive current over rated current is applied, it may cause the inductance value to change due to magnetism.

<Handling>

1. Avoid applying excessive stress to products to prevent damage.
2. Do not touch wire wound with sharp objects such as tweezers to prevent wire breakage.
3. Do not apply excessive force to products mounted on boards to prevent core breakage.

<Transportation>

Do not apply excessive vibration or mechanical shock to products.

Continued on the following page. ↗

⚠ Note • Please read rating and ⚠ CAUTION (for storage, operating, rating, soldering, mounting and handling) in this catalog to prevent smoking and/or burning, etc.
• This catalog has only typical specifications. Therefore, please approve our product specifications or transact the approval sheet for product specifications before ordering.

<Resin Coating>

When coating products with resin, the relatively high resin curing stress may change inductance values. For exterior coating, select resin carefully so that electrical and mechanical performance of the product is not affected. Prior to use, please evaluate reliability with the product mounted in your application set. (LQW, LQH series)

An open circuit issue may occur by mechanical stress caused by the resin, amount/cured shape of resin, or operating conditions, etc. Some resins containing impurities or chloride may possibly generate chlorine by hydrolysis under some operating conditions, causing corrosion of the inductor wire and leading to an open circuit.

<Rated Current>

(LQH2HP_G0·LQH2HP_J0 Series)

Inductance will be more than the value, which is 30% down from minimum rated Inductance value.

(Other LQH_P Series except for LQH2HP_G0 Series)

Inductance will be within ±30% of nominal Inductance value.

• Based on Temperature Rise

For LQH2MC series and LQH_P series, rated current is set to keep temperature rise caused by self heating 40°C or less.

For other Inductors for Power Lines, please refer to individual specifications.

<Handling of a Substrate>

After mounting products on a substrate, do not apply any stress to the product caused by bending or twisting the substrate when cropping the substrate, inserting and removing a connector from the substrate, or tightening a screw to the substrate. Excessive mechanical stress may cause cracking in the Product.

Bending

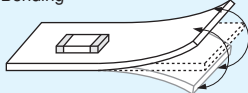

Twisting

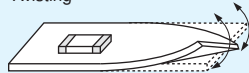

● Measuring Method

Measuring Method of Inductance/Q

1. Residual elements and stray elements of test fixtures can be described by F-parameter as shown in the following:

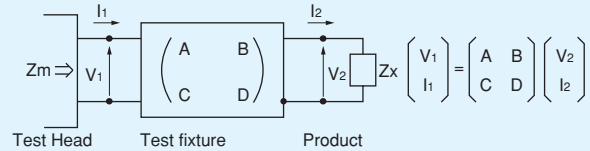

2. The impedance of chip inductors (chip coils) Z_x and measured value Z_m can be described by input/output current/voltage.

$$Z_m = \frac{V_1}{I_1}, \quad Z_x = \frac{V_2}{I_2}$$

3. Thus, the relation between Z_x and Z_m is shown in the following:

$$Z_x = \alpha \frac{Z_m - \beta}{1 - Z_m \Gamma} \quad \text{where, } \alpha = D / A = 1$$

$$\beta = B / D = Z_{sm} - (1 - Y_{om} Z_{sm}) Z_{ss}$$

$$\Gamma = C / A = Y_{om}$$

Z_{sm} : measured impedance of short chip
 Z_{ss} : residual impedance of short chip*
 Y_{om} : measured admittance when opening the fixture

*Residual impedance of short chip

Residual Impedance	Series
0.556nH	LQW15C
0.771nH	LQW18C

4. L_x and Q_x should be calculated with the following equation.

$$L_x = \frac{\text{Im}(Z_x)}{2\pi f}, \quad Q_x = \frac{\text{Im}(Z_x)}{\text{Re}(Z_x)}$$

L_x : Inductance of chip Inductors (chip coils)
 Q_x : Q of chip Inductors (chip coils)
 f : Measuring frequency

⚠ Note • Please read rating and ⚠ CAUTION (for storage, operating, rating, soldering, mounting and handling) in this catalog to prevent smoking and/or burning, etc.
 • This catalog has only typical specifications. Therefore, please approve our product specifications or transact the approval sheet for product specifications before ordering.

Inductors for Power Lines Soldering and Mounting

1. Standard Land Pattern Dimensions

A high Q value is achieved when the PCB electrode land pattern is designed so that it does not project beyond the chip Inductors (chip coils) electrode.

Land Pattern + Solder Resist
 Land Pattern
 Solder Resist
 (in mm)

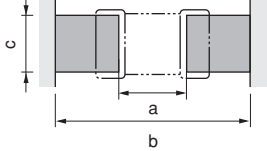
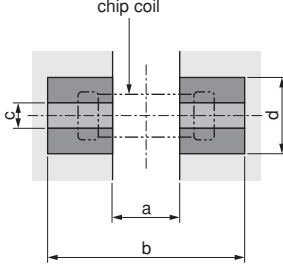
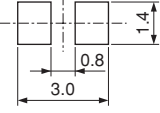
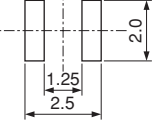
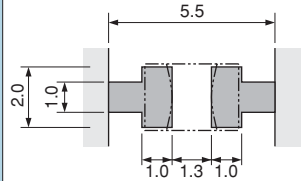
Series	Standard Land Dimensions										
LQM18F/18P LQM21D/21F/21P LQM2MP (Expect for LQM2MP_GH) LQM2HP (Except for LQM2HP_GH/JH) LQM31P LQM32P LQH2MC LQH31C LQH32P LQH44P LQH5BP LQH55D/66S LQW15C_00 LQW15C_10 LQW18C		Part Number		a	b	c					
		LQM18F/18P	Flow	0.7	2.2-2.6	0.7					
			Reflow				1.8-2.0				
				LQM21D/21F/21P		1.2	3.0-4.0	1.0			
				LQM2MP		0.8	2.4	1.8			
				LQM2HP		1.6	3.0	1.5			
				LQM31P		2.0	4.2-5.2	1.2			
				LQM32P		1.9	3.6	2.7			
				LQH2MC		0.8	2.6	1.0			
				LQH31C		1.0	4.5	1.5			
				LQH32P		1.3	3.8	2.0			
				LQH44P		1.3	4.4	3.0			
				LQH5BP		1.8	5.5	4.1			
				LQH55D/66S		2.0	8.0	3.5			
				LQW15C_00		0.4	1.4	0.6			
				LQW15C_10		0.4	1.4	0.66			
				LQW18C		0.7	2.2	1.0			
		LQM2MP_GH LQM2HP_GH/JH		Part Number	Rated Current (A)	a	b	c	Land Pad Thickness and Dimension d		
									18µm	35µm	70µm
				LQM2MP_GH	0-1.5	0.8	2.4	1.8	1.8	1.8	1.8
1.5-2.5	2.4				1.8				1.8		
2.5-5.0	5.0				2.4				1.8		
LQM2HP_GH	0-1.5			1.6	3.0	1.5	1.5	1.5	1.5		
	1.5-2.6						2.4	1.5	1.5		
	2.6-3.3						3.6	2.4	1.5		
LQM2HP_JH	0-1.6			1.6	3.0	1.5	1.5	1.5	1.5		
	1.6-2.4						2.4	1.5	1.5		
	2.4-3.5	3.6	2.4				1.5				
LQH2HP (Except for LQH2HP_GR)											
LQH2HP_GR											
LQH32C											

Attention should be paid to potential magnetic coupling effects when using the Inductors (coils) as a resonator.

Continued on the following page.

⚠Note • Please read rating and ⚠CAUTION (for storage, operating, rating, soldering, mounting and handling) in this catalog to prevent smoking and/or burning, etc.
 • This catalog has only typical specifications. Therefore, please approve our product specifications or transact the approval sheet for product specifications before ordering.

Land Pattern + Solder Resist
 Land Pattern
 Solder Resist
 (in mm)

Series	Standard Land Dimensions
LQH3NP	
LQH43C LQH43P	

2. Standard Soldering Conditions

(1) Soldering method

Chip Inductors (Chip coils) can be flow or reflow soldered. Please contact Murata regarding other soldering methods. As for LQH2MC/2HP/3NP/32P/44P/5BP/55D/66S, LQM2MP_GH/2HP_GH/2HP_JH/32P, LQW15C/18C series, please use reflow soldering.

Solder: Use Sn-3.0Ag-0.5Cu solder.

Flux: Use rosin-based flux, but not strongly acidic flux (with chlorine content exceeding 0.2wt%).

Do not use water-soluble flux.

The flux used for LQW15C/18C series should use the rosin-based flux that includes middle activator equivalent to 0.06wt% to 0.1wt% chlorine.

For additional mounting methods, please contact Murata.

(2) Soldering profile

● Flow Soldering profile (Sn-3.0Ag-0.5Cu solder)

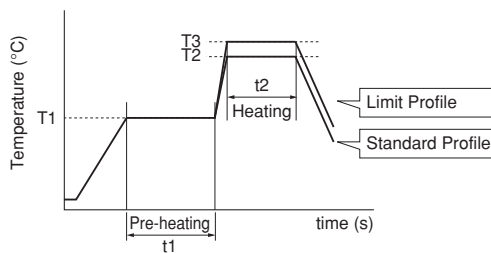

Series	Pre-heating		Standard Profile			Limit Profile		
	Temp. (T1)	Time. (t1)	Heating		Cycle of flow	Heating		Cycle of flow
			Temp. (T2)	Time. (t2)		Temp. (T3)	Time. (t2)	
LQM18F/18P LQM21D/21F/21P/2MP/2HP (Except for LQM2HP_GH/JH) LQM31P LQH31C	150°C	60s min.	250°C	4 to 6s	2 times max.	265±3°C	5s max.	2 times max.
LQH32C LQH43C/43P	150°C	60s min.	250°C	4 to 6s	2 times max.	265±3°C	5s max.	1 times

Continued on the following page.

⚠Note • Please read rating and ⚠CAUTION (for storage, operating, rating, soldering, mounting and handling) in this catalog to prevent smoking and/or burning, etc.
 • This catalog has only typical specifications. Therefore, please approve our product specifications or transact the approval sheet for product specifications before ordering.

Inductors for Power Lines
 Soldering and Mounting
 Inductors for General Use
 RF Inductors

● Reflow Soldering profile
(Sn-3.0Ag-0.5Cu solder)

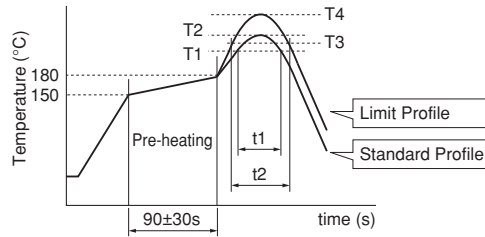

Series	Standard Profile				Limit Profile			
	Heating		Peak temperature (T2)	Cycle of reflow	Heating		Peak temperature (T4)	Cycle of reflow
	Temp. (T1)	Time. (t1)			Temp. (T3)	Time. (t2)		
LQM18F/18P LQM21D/21F/21P/2MP/2HP LQM31P/32P LQH2MC, LQH2HP LQH31C LQH3NP/32P/43P/44P/5BP LQW15C/18C	220°C	30 to 60s	245±3°C	2 times max.	230°C	60s max.	260°C/10s	2 times max.
LQH32C LQH43C LQH55D, LQH66S	220°C	30 to 60s	245±3°C	2 times max.	230°C	60s max.	260°C/10s	1 time

(3) Reworking with Soldering Iron
Preheating at 150°C for 1 minute is required. Do not directly touch the ceramic element with the tip of the soldering iron. The reworking soldering conditions are as follows:

Soldering iron power output: 80W max.
Temperature of soldering iron tip: 350°C
Diameter of soldering iron end: 3.0mm max.
Soldering time: within 3 s

3. Mounting Instructions

(1) Land Pattern Dimensions

Large lands reduce Q of the mounted chip. Also, large protruding land areas (bordered by lines having dimensions 'c' and 'd' shown) cause floating and electrode leaching.

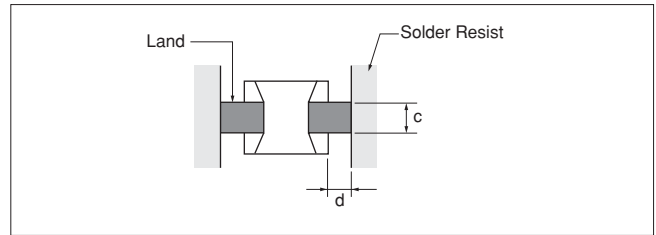

(2) Land Pattern Designing (LQH series, LQW series)

Please follow the recommended patterns. Otherwise, their performance, which includes electrical performance or solderability, may be affected, or result in "position shift" in the soldering process.

(3) Magnetic Coupling

Since some chip inductors (chip coils) are constructed like an open magnetic circuit, narrow spacing between inductors (coils) may cause magnetic coupling. LQM, LQH66S, and LQH_P series have a magnetically shielded structure. The structure makes their coupling coefficient smaller than that of conventional chip inductors (chip coils).

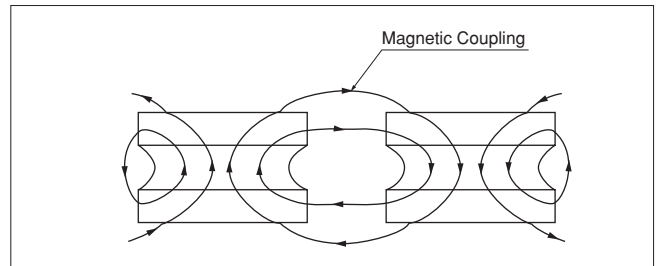

Continued on the following page.

⚠Note • Please read rating and ⚠CAUTION (for storage, operating, rating, soldering, mounting and handling) in this catalog to prevent smoking and/or burning, etc.
• This catalog has only typical specifications. Therefore, please approve our product specifications or transact the approval sheet for product specifications before ordering.

(4) PCB Warping

PCB should be designed so that products are not subjected to the mechanical stress caused by warping the board.

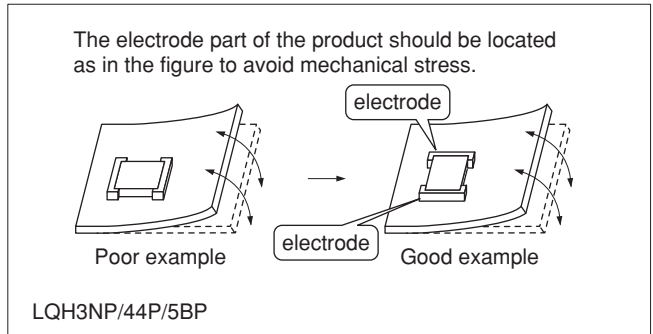
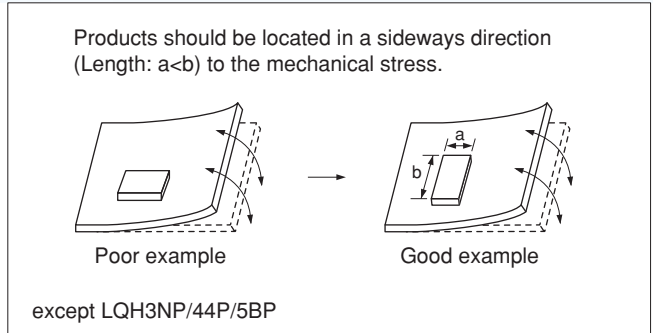

(5) Amount of Solder Paste

Excessive solder causes electrode corrosion, while insufficient solder causes low electrode bonding strength. Adjust the amount of solder paste as shown on the right so that solder is applied.

● Guideline of solder paste thickness

- LQW15C: 50 to 100µm
- LQM, LQW18C, LQH2MC/2HP, LQH3NP/32P, LQH44P/5BP/55P: 100 to 150µm
- LQH31C/32C, LQH43C/43P, LQH55D, LQH66S: 200 to 300µm

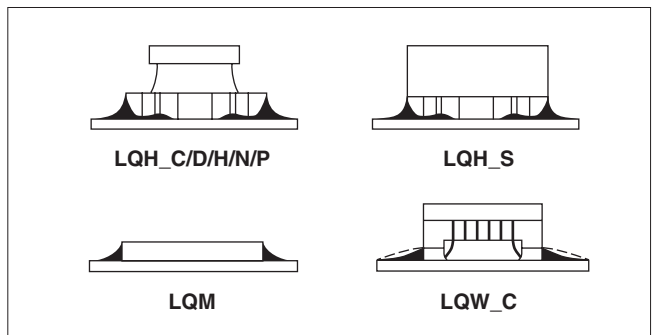

(6) Amount of Adhesive

If too much adhesive is applied, then it may overflow into the land or termination areas and yield poor solderability. In contrast, if insufficient adhesive is applied, or if the adhesive is not sufficiently hardened, then the chip may become detached during flow soldering. Apply the adhesive in accordance with the conditions shown in the chart.

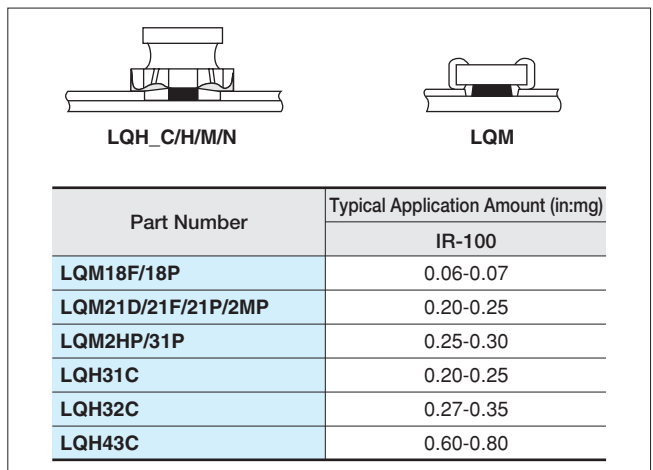

Continued on the following page. ↗

⚠Note • Please read rating and ⚠CAUTION (for storage, operating, rating, soldering, mounting and handling) in this catalog to prevent smoking and/or burning, etc.
 • This catalog has only typical specifications. Therefore, please approve our product specifications or transact the approval sheet for product specifications before ordering.

4. Cleaning

The following conditions should be observed when cleaning chip inductors (chip coils):

- (1) Cleaning Temperature: 60°C max. (40°C max. for alcohol cleaning agents)
- (2) Ultrasonic
Output: 20W/l max.
Duration: 5 minutes max.
Frequency: 28 to 40kHz
Care should be taken not to cause resonance of the PCB and mounted products.
- (3) Cleaning agent
The following cleaning agents have been tested on individual components. Evaluation in complete assembly should be done prior to production.
 - (a) Alcohol cleaning agents
Isopropyl alcohol (IPA)
 - (b) Aqueous cleaning agents
Pine Alpha ST-100S
LQH66S series: Aqueous agents should not be used because they may cause quality deterioration or damage to appearance.

- (4) Ensure that flux residue is completely removed.
Component should be thoroughly dried after aqueous agents have been removed with deionized water.

For additional cleaning methods, please contact Murata.

■ Minimum Quantity and 8mm Width Taping Dimensions

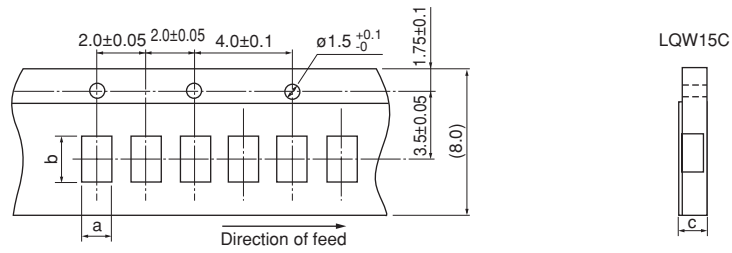

Paper Tape

Part Number	Dimensions		Total Thickness of Tape	Packaging Code (Minimum Qty. [pcs.])		
	a	b		c	ø180mm reel	ø330mm reel
LQW15C_00	0.64	1.18	0.8 max.	D [10000]	-	B [500]
LQW15C_10	0.69	1.18	0.8 max.	D [10000]	-	B [500]

(in mm)

Continued on the following page.

Note • Please read rating and **CAUTION** (for storage, operating, rating, soldering, mounting and handling) in this catalog to prevent smoking and/or burning, etc.
 • This catalog has only typical specifications. Therefore, please approve our product specifications or transact the approval sheet for product specifications before ordering.

■ Minimum Quantity and 8mm Width Taping Dimensions

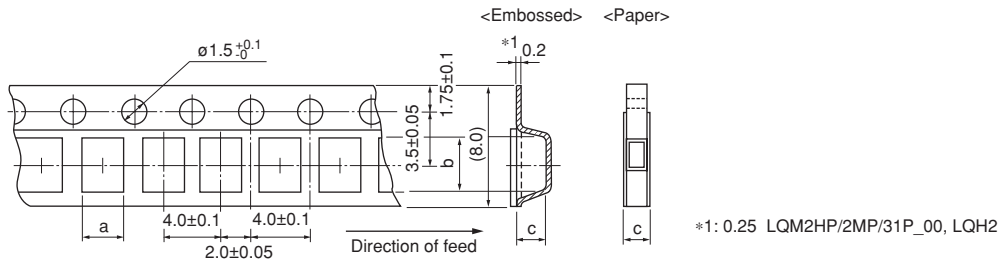

Dimension of the cavity of embossed tape is measured at the bottom side.

Paper Tape

Part Number	Dimensions		Total Thickness of Tape	Packaging Code (Minimum Qty. [pcs.])		
	a	b		c	ø180mm reel	ø330mm reel
LQM21D (1-10μH)	1.45	2.25	1.1 max.	D [4000]	J [10000]	B [1000]
LQM21F (1-2.2μH)	1.45	2.25	1.1 max.	D [4000]	J [10000]	B [1000]
LQM21P_C0	1.45	2.25	0.8 max.	D [4000]	-	B [1000]
LQM21P_G	1.45	2.25	1.1 max.	D [4000]	-	B [1000]
LQM18F	1.05	1.85	1.1 max.	D [4000]	J [10000]	B [1000]
LQM18P_D0	1.05	1.85	0.85 max.	D [4000]	-	B [1000]
LQW18C	1.0	1.8	1.1 max.	D [4000]	-	B [500]

Embossed Tape

Part Number	Dimensions		Depth of Cavity	Packaging Code (Minimum Qty. [pcs.])		
	a	b		c	ø180mm reel	ø330mm reel
LQM18P_B0	1.0	1.8	0.50	L [4000]	-	B [1000]
LQM18P_C0	1.0	1.8	0.60	L [4000]	-	B [1000]
LQM18P_F0	1.0	1.8	1.0	L [4000]	-	B [1000]
LQM21D (22-47μH)	1.45	2.25	1.3	L [3000]	K [10000]	B [1000]
LQM21F (4.7-47μH)	1.45	2.25	1.3	L [3000]	K [10000]	B [1000]
LQM2HP_J0/JC	2.25	2.75	1.3	L [3000]	-	B [1000]
LQM2HP_JH	2.25	2.75	1.3	L [3000]	-	-
LQM2HP_G	2.3	2.8	1.1	L [3000]	-	B [1000]
LQM2HP_GH	2.3	2.8	1.1	L [3000]	-	-
LQM2HP_E0	2.3	2.8	0.9	L [3000]	-	B [1000]
LQM2MP_G0	1.85	2.25	1.1	L [3000]	-	B [1000]
LQM2MP_GH	1.9	2.4	1.1	L [3000]	-	-
LQM31P_00	1.9	3.5	1.05	L [3000]	-	B [1000]
LQM31P_C0	1.9	3.5	0.75	L [4000]	-	B [1000]
LQM32P_G0	2.9	3.6	1.15	L [3000]	-	B [1000]
LQH31C	1.9	3.6	2.0	L [2000]	K [7500]	-
LQH32C_33/23	2.9	3.6	2.1	L [2000]	K [7500]	-
LQH32C_53	2.9	3.6	1.7	L [2000]	K [7500]	-
LQH32P	2.9	3.6	1.7	L [2000]	K [7500]	-
LQH2MC_02	1.9	2.3	1.05	L [3000]	-	B [100]
LQH2MC_52	1.9	2.3	0.8	L [3000]	-	B [100]

(in mm)

Continued on the following page.

△Note • Please read rating and △CAUTION (for storage, operating, rating, soldering, mounting and handling) in this catalog to prevent smoking and/or burning, etc.
• This catalog has only typical specifications. Therefore, please approve our product specifications or transact the approval sheet for product specifications before ordering.

■ Minimum Quantity and 8mm Width Taping Dimensions

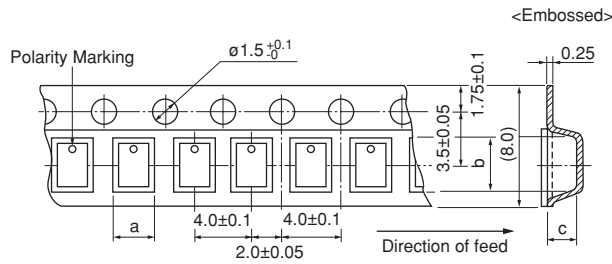

Dimension of the cavity of embossed tape is measured at the bottom side.

Embossed Tape

Part Number	Dimensions		Depth of Cavity	Packaging Code (Minimum Qty. [pcs.])		
	a	b		$\phi 180\text{mm}$ reel	$\phi 330\text{mm}$ reel	Bulk
LQH2HP_G0/GR	2.3	2.8	1.1	L [3000]	-	-
LQH2HP_J0	2.3	2.8	1.3	L [2000]	-	-
LQH2HP_M0	2.3	2.8	1.6	L [2000]	-	-

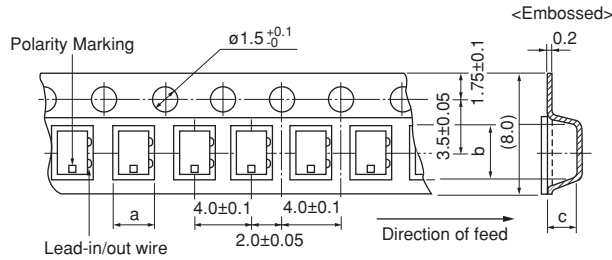

Dimension of the cavity of embossed tape is measured at the bottom side.

Embossed Tape

Part Number	Dimensions		Depth of Cavity	Packaging Code (Minimum Qty. [pcs.])		
	a	b		$\phi 180\text{mm}$ reel	$\phi 330\text{mm}$ reel	Bulk
LQH3NP_MR	3.3	3.3	1.6	E [2000]	F [8000]	-

(in mm)

Continued on the following page.

Note • Please read rating and **CAUTION** (for storage, operating, rating, soldering, mounting and handling) in this catalog to prevent smoking and/or burning, etc.
 • This catalog has only typical specifications. Therefore, please approve our product specifications or transact the approval sheet for product specifications before ordering.

■ Minimum Quantity and 12mm Width Embossed Taping Dimensions

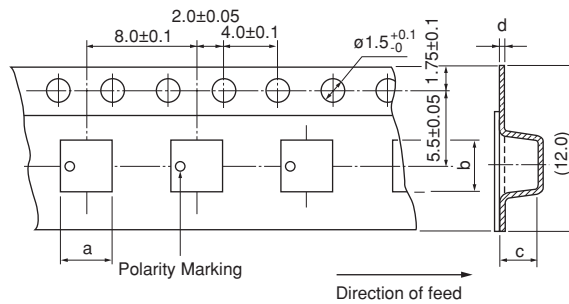

Dimension of the cavity of embossed tape is measured at the bottom side.

Embossed Tape

Part Number	Dimensions (*c: Depth of Cavity)				Packaging Code (Minimum Qty. [pcs.])		
	a	b	c	d	ø180mm reel	ø330mm reel	Bulk
LQH3NP_M0	3.3	3.3	1.6	0.25	L [1000]	K [4000]	-
LQH3NP_J0	3.3	3.3	1.3	0.25	L [1000]	K [5000]	-
LQH3NP_G0	3.3	3.3	1.1	0.25	L [1500]	K [6000]	-

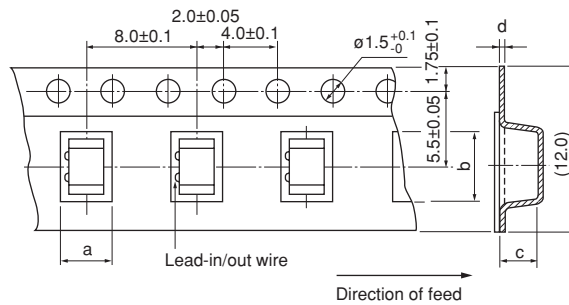

Dimension of the cavity of embossed tape is measured at the bottom side.

Embossed Tape

Part Number	Dimensions (*c: Depth of Cavity)				Packaging Code (Minimum Qty. [pcs.])		
	a	b	c	d	ø180mm reel	ø330mm reel	Bulk
LQH43C	3.6	4.9	2.7	0.3	L [500]	-	-
LQH43P	3.6	4.9	2.7	0.3	L [500]	K [2500]	-
LQH44 P_J0	4.3	4.3	1.4	0.3	L [1000]	K [3500]	-
LQH44P_P0	4.3	4.3	1.9	0.3	L [1000]	K [3500]	-
LQH5BP	5.3	5.3	2.4	0.3	L [500]	K [3000]	-
LQH55D	5.4	6.1	5.0	0.4	L [350]	K [1500]	-
LQH66S	6.7	6.7	5.6	0.4	L [350]	K [1500]	-

(in mm)

△Note • Please read rating and △CAUTION (for storage, operating, rating, soldering, mounting and handling) in this catalog to prevent smoking and/or burning, etc.
 • This catalog has only typical specifications. Therefore, please approve our product specifications or transact the approval sheet for product specifications before ordering.

■ Holder Type



● EKLMQM2PK-KIT (Inductors for Power Lines: Multilayer Type)

No.	Part Number	Quantity (pcs.)	Inductance		DC Resistance (Ω)	Rated Current (mA)
			Nominal	Tolerance		
1	LQM18PN1R5NB0	10	1.5μH	±30%	0.35±25%	600
2	LQM18PN1R8NC0	10	1.8μH	±30%	0.24±25%	700
3	LQM18PN2R5ND0	10	2.5μH	±30%	0.24±25%	700
4	LQM18PN1R0NF0	10	1.0μH	±30%	0.28±25%	600
5	LQM18PNR22NFR	10	0.22μH	±30%	0.11±25%	1250
6	LQM18PNR47NFR	10	0.47μH	±30%	0.15±25%	1100
7	LQM18PN1R0MFR	10	1.0μH	±20%	0.20±25%	950
8	LQM18PN1R5MFR	10	1.5μH	±20%	0.23±25%	800
9	LQM18PN2R2MFR	10	2.2μH	±20%	0.30±25%	750
10	LQM18PN3R3MFR	10	3.3μH	±20%	0.35±25%	700
11	LQM18PN4R7MFR	10	4.7μH	±20%	0.44±25%	620
12	LQM21PNR47MC0	10	0.47μH	±20%	0.12±25%	1100
13	LQM21PN1R0MC0	10	1.0μH	±20%	0.19±25%	800
14	LQM21PN1R5MC0	10	1.5μH	±20%	0.26±25%	700
15	LQM21PN2R2MC0	10	2.2μH	±20%	0.34±25%	600
16	LQM21PNR47MG0	10	0.47μH	±20%	0.075±25%	1300
17	LQM21PNR54MG0	10	0.54μH	±20%	0.075±25%	1300
18	LQM21PN3R3MG0	10	3.3μH	±20%	0.165±25%	800
19	LQM21PN2R2MGS	10	2.2μH	±20%	0.180±25%	950
20	LQM21PN4R7MGS	10	4.7μH	±20%	0.290±25%	750
21	LQM21PN1R0NGC	10	1.0μH	±30%	0.10±25%	900
22	LQM21PN2R2NGC	10	2.2μH	±30%	0.23±25%	800
23	LQM21PN1R0NGR	10	1.0μH	±30%	0.066±25%	1300
24	LQM21PN3R3MGR	10	3.3μH	±20%	0.150±25%	1000
25	LQM21PN4R7MGR	10	4.7μH	±20%	0.23±25%	800
26	LQM2MPNR47MG0	10	0.47μH	±20%	0.060±25%	1600
27	LQM2MPN1R0NG0	10	1.0μH	±30%	0.085±25%	1400
28	LQM2MPN1R5MG0	10	1.5μH	±20%	0.11±25%	1200
29	LQM2MPN2R2MG0	10	2.2μH	±20%	0.11±25%	1200
30	LQM2MPN3R3NG0	10	3.3μH	±30%	0.12±25%	1200
31	LQM2MPN4R7MG0	10	4.7μH	±20%	0.14±25%	1100
32	LQM2HPNR56ME0	10	0.56μH	±20%	0.06±25%	1500
33	LQM2HPNR47MG0	10	0.47μH	±20%	0.04±25%	1800
34	LQM2HPN1R0MG0	10	1.0μH	±20%	0.055±25%	1600
35	LQM2HPN1R5MG0	10	1.5μH	±20%	0.07±25%	1500
36	LQM2HPN2R2MG0	10	2.2μH	±20%	0.08±25%	1300
37	LQM2HPN3R3MG0	10	3.3μH	±20%	0.10±25%	1200
38	LQM2HPN4R7MG0	10	4.7μH	±20%	0.11±25%	1100
39	LQM2HPN1R0MGC	10	1.0μH	±20%	0.08±25%	1500
40	LQM2HPN3R3MGC	10	3.3μH	±20%	0.16±25%	1000
41	LQM2HPN4R7MGC	10	4.7μH	±20%	0.18±25%	800
42	LQM2HPN2R2MGS	10	2.2μH	±20%	0.18±25%	1100
43	LQM2HPN3R3MGS	10	3.3μH	±20%	0.21±25%	1050
44	LQM2HPN4R7MGS	10	4.7μH	±20%	0.25±25%	1000
45	LQM2HPN1R0MJ0	10	1.0μH	±20%	0.09±25%	1500
46	LQM2HPN2R2MJ0	10	2.2μH	±20%	0.12±25%	1000
47	LQM2HPN3R3MJ0	10	3.3μH	±20%	0.12±25%	1000
48	LQM2HPN1R0MJC	10	1.0μH	±20%	0.086±25%	1500
49	LQM2HPN2R2NJC	10	2.2μH	±30%	0.175±25%	1000
50	LQM31PNR47MC0	10	0.47μH	±20%	0.085±25%	1300
51	LQM31PN1R0MC0	10	1.0μH	±20%	0.14±25%	1100
52	LQM31PN1R5MC0	10	1.5μH	±20%	0.17±25%	1000
53	LQM31PN2R2MC0	10	2.2μH	±20%	0.25±25%	900
54	LQM31PNR47M00	10	0.47μH	±20%	0.07±25%	1400
55	LQM31PN1R0M00	10	1.0μH	±20%	0.12±25%	1200

Continued on the following page.

⚠Note • Please read rating and ⚠CAUTION (for storage, operating, rating, soldering, mounting and handling) in this catalog to prevent smoking and/or burning, etc.
• This catalog has only typical specifications. Therefore, please approve our product specifications or transact the approval sheet for product specifications before ordering.

Continued from the preceding page.

No.	Part Number	Quantity (pcs.)	Inductance		DC Resistance (Ω)	Rated Current (mA)
			Nominal	Tolerance		
56	LQM31PN1R5M00	10	1.5μH	±20%	0.14±25%	1000
57	LQM31PN2R2M00	10	2.2μH	±20%	0.19±25%	900
58	LQM31PN3R3M00	10	3.3μH	±20%	0.24±25%	800
59	LQM31PN4R7M00	10	4.7μH	±20%	0.30±25%	700
60	LQM32PN1R0MG0	10	1.0μH	±20%	0.048±25%	1800

●EKLMM18FC-KIT (Inductors for Power Lines: Multilayer Type)

No.	Part Number	Quantity (pcs.)	Inductance		DC Resistance (Ω)	Rated Current (mA)
			Nominal	Tolerance		
1	LQM18FN1R0M00	10	1.0μH	±20%	0.20±30%	150
2	LQM18FN2R2M00	10	2.2μH	±20%	0.40±30%	120
3	LQM18FN4R7M00	10	4.7μH	±20%	0.60±30%	80
4	LQM18FN100M00	10	10μH	±20%	0.90±30%	50
5	LQM21FN1R0N00	10	1.0μH	±30%	0.20±30%	220
6	LQM21FN2R2N00	10	2.2μH	±30%	0.28±30%	150
7	LQM21FN220N00	10	22μH	±30%	0.35±30%	13
8	LQM21FN470N00	10	47μH	±30%	0.60±30%	7
9	LQM21FN4R7M70	10	4.7μH	±20%	0.35±30%	120
10	LQM21FN100M70	10	10μH	±20%	0.60±30%	100
11	LQM21FN4R7M80	10	4.7μH	±20%	0.18±30%	120
12	LQM21FN100M80	10	10μH	±20%	0.30±30%	100

●EKLHM2MCK-KIT (Inductors for Power Lines: Wire Wound Type)

No.	Part Number	Quantity (pcs.)	Inductance		DC Resistance (Ω)	Rated Current (mA)	
			Nominal	Tolerance		Based on Inductance Change	Based on Temperature Rise
1	LQH2MCN1R0M02	10	1.0μH	±20%	0.30±30%	-	485
2	LQH2MCN1R5M02	10	1.5μH	±20%	0.40±30%	-	445
3	LQH2MCN2R2M02	10	2.2μH	±20%	0.48±30%	-	425
4	LQH2MCN3R3M02	10	3.3μH	±20%	0.60±30%	-	375
5	LQH2MCN4R7M02	10	4.7μH	±20%	0.8±30%	-	300
6	LQH2MCN5R6M02	10	5.6μH	±20%	0.9±30%	-	280
7	LQH2MCN6R8M02	10	6.8μH	±20%	1.0±30%	-	255
8	LQH2MCN8R2M02	10	8.2μH	±20%	1.1±30%	-	235
9	LQH2MCN100K02	10	10μH	±10%	1.2±30%	-	225
10	LQH2MCN120K02	10	12μH	±10%	1.4±30%	-	210
11	LQH2MCN150K02	10	15μH	±10%	1.6±30%	-	200
12	LQH2MCN180K02	10	18μH	±10%	1.8±30%	-	190
13	LQH2MCN220K02	10	22μH	±10%	2.1±30%	-	185
14	LQH2MCN270K02	10	27μH	±10%	2.5±30%	-	180
15	LQH2MCN330K02	10	33μH	±10%	2.8±30%	-	160
16	LQH2MCN390K02	10	39μH	±10%	4.4±30%	-	125
17	LQH2MCN470K02	10	47μH	±10%	5.1±30%	-	120
18	LQH2MCN560K02	10	56μH	±10%	5.7±30%	-	110
19	LQH2MCN680K02	10	68μH	±10%	6.6±30%	-	100
20	LQH2MCN820K02	10	82μH	±10%	7.5±30%	-	90
21	LQH2MCN1R0M52	10	1.0μH	±20%	0.25±30%	-	595
22	LQH2MCN1R5M52	10	1.5μH	±20%	0.33±30%	-	540
23	LQH2MCN2R2M52	10	2.2μH	±20%	0.42±30%	-	500
24	LQH2MCN3R3M52	10	3.3μH	±20%	0.74±30%	-	360
25	LQH2MCN4R7M52	10	4.7μH	±20%	0.91±30%	-	335
26	LQH2MCN6R8M52	10	6.8μH	±20%	1.23±30%	-	285
27	LQH2MCN100M52	10	10μH	±20%	2.27±30%	-	200
28	LQH2MCN120M52	10	12μH	±20%	2.4±30%	-	170
29	LQH2MCN150M52	10	15μH	±20%	3.5±30%	-	150
30	LQH2MCN180M52	10	18μH	±20%	4±30%	-	140
31	LQH2MCN220M52	10	22μH	±20%	5.5±30%	-	130
32	LQH2HPN2R2MG0	10	2.2μH	±20%	0.17±20%	1640	1000
33	LQH2HPN3R3MG0	10	3.3μH	±20%	0.27±20%	1290	810
34	LQH2HPN4R7MG0	10	4.7μH	±20%	0.36±20%	1000	700
35	LQH2HPN6R8MG0	10	6.8μH	±20%	0.5±20%	800	590
36	LQH2HPN100MG0	10	10μH	±20%	0.73±20%	700	490
37	LQH2HPN220MG0	10	22μH	±20%	1.6±20%	490	340
38	LQH2HPN101MG0	10	100μH	±20%	10±20%	210	130
39	LQH2HPN1R0MGR	10	1.0μH	±20%	0.068±20%	2130	2100
40	LQH2HPN2R2MGR	10	2.2μH	±20%	0.134±20%	1550	1470

Continued on the following page. ↗

⚠Note • Please read rating and ⚠CAUTION (for storage, operating, rating, soldering, mounting and handling) in this catalog to prevent smoking and/or burning, etc.
• This catalog has only typical specifications. Therefore, please approve our product specifications or transact the approval sheet for product specifications before ordering.

Continued from the preceding page.

No.	Part Number	Quantity (pcs.)	Inductance		DC Resistance (Ω)	Rated Current (mA)	
			Nominal	Tolerance		Based on Inductance Change	Based on Temperature Rise
41	LQH2HPN1R5NJ0	10	1.5μH	±30%	0.096±20%	2400	1500
42	LQH2HPN2R2MJ0	10	2.2μH	±20%	0.132±20%	1800	1300
43	LQH2HPN3R3MJ0	10	3.3μH	±20%	0.230±20%	1500	950
44	LQH2HPN4R7MJ0	10	4.7μH	±20%	0.330±20%	1250	700
45	LQH2HPN6R8MJ0	10	6.8μH	±20%	0.448±20%	1100	600
46	LQH2HPN100MJ0	10	10μH	±20%	0.641±20%	820	550
47	LQH2HPN2R2MM0	10	2.2μH	±20%	0.146±20%	1700	1250
48	LQH2HPN4R7NM0	10	4.7μH	±30%	0.342±20%	1200	800

●EKLQMH3PE-KIT (Inductors for Power Lines: Wire Wound Type)

No.	Part Number	Quantity (pcs.)	Inductance		DC Resistance (Ω)	Rated Current (mA)	
			Nominal	Tolerance		Based on Inductance Change	Based on Temperature Rise
1	LQH3NPN1R0NG0	10	1.0μH	±30%	0.08±20%	1650	1525
2	LQH3NPN1R5NG0	10	1.5μH	±30%	0.10±20%	1300	1470
3	LQH3NPN2R2NG0	10	2.2μH	±30%	0.14±20%	1250	1270
4	LQH3NPN3R3NG0	10	3.3μH	±30%	0.18±20%	850	1130
5	LQH3NPN4R7NG0	10	4.7μH	±30%	0.26±20%	800	925
6	LQH3NPN6R8NG0	10	6.8μH	±30%	0.45±20%	650	710
7	LQH3NPN100MG0	10	10μH	±20%	0.57±20%	500	630
8	LQH3NPN150NG0	10	15μH	±30%	0.91±20%	370	475
9	LQH3NPN220MG0	10	22μH	±20%	1.1±20%	340	430
10	LQH3NPN330MG0	10	33μH	±20%	2.1±20%	250	345
11	LQH3NPN470MG0	10	47μH	±20%	3.0±20%	170	270
12	LQH3NPN680MG0	10	68μH	±20%	4.2±20%	150	235
13	LQH3NPN101MG0	10	100μH	±20%	8.0±20%	140	165
14	LQH3NPN151MG0	10	150μH	±20%	11±20%	110	145
15	LQH3NPN221MG0	10	220μH	±20%	14±20%	100	130
16	LQH3NPN251MG0	10	250μH	±20%	15±20%	80	130
17	LQH3NPN1R0NJ0	10	1.0μH	±30%	0.040±20%	1650	1620
18	LQH3NPN1R5NJ0	10	1.5μH	±30%	0.055±20%	1200	1500
19	LQH3NPN2R2MJ0	10	2.2μH	±20%	0.069±20%	1150	1460
20	LQH3NPN3R3MJ0	10	3.3μH	±20%	0.105±20%	950	1270
21	LQH3NPN4R7MJ0	10	4.7μH	±20%	0.130±20%	780	1120
22	LQH3NPN6R8MJ0	10	6.8μH	±20%	0.210±20%	700	850
23	LQH3NPN100MJ0	10	10μH	±20%	0.300±20%	560	710
24	LQH3NPN150MJ0	10	15μH	±20%	0.440±20%	440	590
25	LQH3NPN220MJ0	10	22μH	±20%	0.600±20%	350	510
26	LQH3NPN330MJ0	10	33μH	±20%	0.900±20%	280	410
27	LQH3NPN470MJ0	10	47μH	±20%	1.30±20%	200	350
28	LQH3NPN1R0MM0	10	1.0μH	±20%	0.044±20%	1400	2050
29	LQH3NPN2R2MM0	10	2.2μH	±20%	0.073±20%	1250	1600
30	LQH3NPN3R3MM0	10	3.3μH	±20%	0.092±20%	1000	1450
31	LQH3NPN4R7MM0	10	4.7μH	±20%	0.13±20%	880	1250
32	LQH3NPN6R8MM0	10	6.8μH	±20%	0.20±20%	820	1000
33	LQH3NPN100MM0	10	10μH	±20%	0.26±20%	550	870
34	LQH3NPN150MM0	10	15μH	±20%	0.36±20%	520	730
35	LQH3NPN220MM0	10	22μH	±20%	0.51±20%	410	650
36	LQH3NPN330MM0	10	33μH	±20%	0.85±20%	370	500
37	LQH3NPN470MM0	10	47μH	±20%	1.25±20%	310	410
38	LQH3NPN101MM0	10	100μH	±20%	3.50±20%	200	240
39	LQH3NPN1R0MMR	10	1.0μH	±20%	0.042±20%	1600	2150
40	LQH3NPN2R2MMR	10	2.2μH	±20%	0.068±20%	1380	1750
41	LQH3NPN3R3MMR	10	3.3μH	±20%	0.088±20%	1200	1550
42	LQH3NPN4R7MMR	10	4.7μH	±20%	0.105±20%	950	1400
43	LQH3NPN6R8MMR	10	6.8μH	±20%	0.155±20%	830	1250
44	LQH3NPN100MMR	10	10μH	±20%	0.210±20%	590	1150
45	LQH3NPN220MMR	10	22μH	±20%	0.480±20%	430	750
46	LQH3NPN330MMR	10	33μH	±20%	0.790±20%	380	600
47	LQH3NPN470MMR	10	47μH	±20%	1.140±20%	320	460
48	LQH32PNR47NN0	10	0.47μH	±30%	0.030±20%	3400	2550
49	LQH32PN1R0NN0	10	1.0μH	±30%	0.045±20%	2300	2050
50	LQH32PN1R5NN0	10	1.5μH	±30%	0.057±20%	1750	1750
51	LQH32PN2R2NN0	10	2.2μH	±30%	0.076±20%	1550	1600
52	LQH32PN3R3NN0	10	3.3μH	±30%	0.12±20%	1250	1200
53	LQH32PN4R7NN0	10	4.7μH	±30%	0.18±20%	1000	1000

Continued on the following page. ↗

△Note • Please read rating and △CAUTION (for storage, operating, rating, soldering, mounting and handling) in this catalog to prevent smoking and/or burning, etc.
 • This catalog has only typical specifications. Therefore, please approve our product specifications or transact the approval sheet for product specifications before ordering.

Continued from the preceding page.

No.	Part Number	Quantity (pcs.)	Inductance		DC Resistance (Ω)	Rated Current (mA)	
			Nominal	Tolerance		Based on Inductance Change	Based on Temperature Rise
54	LQH32PN6R8NN0	10	6.8μH	±30%	0.24±20%	850	850
55	LQH32PN100MN0	10	10μH	±20%	0.38±20%	750	700
56	LQH32PN150MN0	10	15μH	±20%	0.57±20%	600	520
57	LQH32PN220MN0	10	22μH	±20%	0.81±20%	500	450
58	LQH32PN330MN0	10	33μH	±20%	1.15±20%	380	390
59	LQH32PN470MN0	10	47μH	±20%	1.78±20%	330	310
60	LQH32PN680MN0	10	68μH	±20%	2.28±20%	280	275
61	LQH32PN101MN0	10	100μH	±20%	2.70±20%	180	250
62	LQH32PN121MN0	10	120μH	±20%	4.38±20%	170	200
63	LQH32PNR47NNC	10	0.47μH	±30%	0.024±20%	4400	2900
64	LQH32PN1R0NNC	10	1.0μH	±30%	0.036±20%	3000	2500
65	LQH32PN1R5NNC	10	1.5μH	±30%	0.053±20%	2600	2100
66	LQH32PN2R2NNC	10	2.2μH	±30%	0.064±20%	2000	1850
67	LQH32PN3R3NNC	10	3.3μH	±30%	0.100±20%	1900	1550
68	LQH32PN4R7NNC	10	4.7μH	±30%	0.155±20%	1600	1200
69	LQH32PN6R8NNC	10	6.8μH	±30%	0.220±20%	1300	1100
70	LQH32PN100MNC	10	10μH	±20%	0.295±20%	1000	900
71	LQH32PN150MNC	10	15μH	±20%	0.475±20%	800	700
72	LQH32PN220MNC	10	22μH	±20%	0.685±20%	650	550

●EKLMQH3BA-KIT (Inductors for Power Lines: Wire Wound Type)

No.	Part Number	Quantity (pcs.)	Inductance		DC Resistance (Ω)	Rated Current (mA)		
			Nominal	Tolerance		Based on Inductance Change	Based on Temperature Rise	
						Ambient temperature 85°C	Ambient temperature 105°C	
1	LQH32PBR47NN0	10	0.47μH	±30%	0.030±20%	3400	2550	1600
2	LQH32PB1R0NN0	10	1.0μH	±30%	0.045±20%	2300	2050	1320
3	LQH32PB1R5NN0	10	1.5μH	±30%	0.057±20%	1750	1750	1010
4	LQH32PB2R2NN0	10	2.2μH	±30%	0.076±20%	1550	1600	970
5	LQH32PB3R3NN0	10	3.3μH	±30%	0.12±20%	1250	1200	670
6	LQH32PB4R7NN0	10	4.7μH	±30%	0.18±20%	1000	1000	530
7	LQH32PB6R8NN0	10	6.8μH	±30%	0.24±20%	850	850	510
8	LQH32PB100MN0	10	10μH	±20%	0.38±20%	750	700	380
9	LQH32PB150MN0	10	15μH	±20%	0.57±20%	600	520	320
10	LQH32PB220MN0	10	22μH	±20%	0.81±20%	500	450	240
11	LQH32PB330MN0	10	33μH	±20%	1.15±20%	380	390	190
12	LQH32PB470MN0	10	47μH	±20%	1.78±20%	330	310	140
13	LQH32PB680MN0	10	68μH	±20%	2.28±20%	280	275	120
14	LQH32PB101MN0	10	100μH	±20%	2.70±20%	180	250	110
15	LQH32PB121MN0	10	120μH	±20%	4.38±20%	170	200	80
16	LQH32PBR47NNC	10	0.47μH	±30%	0.024±20%	4400	2900	1490
17	LQH32PB1R0NNC	10	1.0μH	±30%	0.036±20%	3000	2500	1380
18	LQH32PB1R5NNC	10	1.5μH	±30%	0.053±20%	2600	2100	1110
19	LQH32PB2R2NNC	10	2.2μH	±30%	0.064±20%	2000	1850	910
20	LQH32PB3R3NNC	10	3.3μH	±30%	0.100±20%	1900	1550	800
21	LQH32PB4R7NNC	10	4.7μH	±30%	0.155±20%	1600	1200	610
22	LQH32PB6R8NNC	10	6.8μH	±30%	0.220±20%	1300	1100	550
23	LQH32PB100MNC	10	10μH	±20%	0.295±20%	1000	900	450
24	LQH32PB150MNC	10	15μH	±20%	0.475±20%	800	700	330
25	LQH32PB220MNC	10	22μH	±20%	0.685±20%	650	550	270

●EKLMQH4PD-KIT (Inductors for Power Lines: Wire Wound Type)

No.	Part Number	Quantity (pcs.)	Inductance		DC Resistance (Ω)	Rated Current (mA)	
			Nominal	Tolerance		Based on Inductance Change	Based on Temperature Rise
1	LQH44PN1R0NJ0	10	1.0μH	±30%	0.048±20%	2000	1530
2	LQH44PN1R5MJ0	10	1.5μH	±20%	0.061±20%	1600	1380
3	LQH44PN2R2MJ0	10	2.2μH	±20%	0.074±20%	1320	1230
4	LQH44PN3R3MJ0	10	3.3μH	±20%	0.088±20%	900	1000
5	LQH44PN4R7MJ0	10	4.7μH	±20%	0.117±20%	840	980
6	LQH44PN6R8MJ0	10	6.8μH	±20%	0.143±20%	720	860
7	LQH44PN100MJ0	10	10μH	±20%	0.207±20%	560	790
8	LQH44PN150MJ0	10	15μH	±20%	0.385±20%	430	610
9	LQH44PN220MJ0	10	22μH	±20%	0.480±20%	400	550
10	LQH44PN330MJ0	10	33μH	±20%	0.740±20%	360	430
11	LQH44PN470MJ0	10	47μH	±20%	1.014±20%	300	380
12	LQH44PN1R0NP0	10	1.0μH	±30%	0.030±20%	2950	2450

Continued on the following page. ↗

⚠Note • Please read rating and ⚠CAUTION (for storage, operating, rating, soldering, mounting and handling) in this catalog to prevent smoking and/or burning, etc.
• This catalog has only typical specifications. Therefore, please approve our product specifications or transact the approval sheet for product specifications before ordering.

Continued from the preceding page.

No.	Part Number	Quantity (pcs.)	Inductance		DC Resistance (Ω)	Rated Current (mA)	
			Nominal	Tolerance		Based on Inductance Change	Based on Temperature Rise
13	LQH44PN2R2MP0	10	2.2μH	±20%	0.049±20%	2500	1800
14	LQH44PN3R3MP0	10	3.3μH	±20%	0.065±20%	2100	1770
15	LQH44PN4R7MP0	10	4.7μH	±20%	0.080±20%	1700	1700
16	LQH44PN6R8MP0	10	6.8μH	±20%	0.12±20%	1400	1340
17	LQH44PN100MP0	10	10μH	±20%	0.16±20%	1150	1170
18	LQH44PN220MP0	10	22μH	±20%	0.37±20%	800	790
19	LQH43PN1R0N26	10	1.0μH	±30%	0.026±20%	3400	3300
20	LQH43PN2R2M26	10	2.2μH	±20%	0.042±20%	2300	2500
21	LQH43PN3R3M26	10	3.3μH	±20%	0.052±20%	1800	2100
22	LQH43PN4R7M26	10	4.7μH	±20%	0.075±20%	1400	1600
23	LQH43PN6R8M26	10	6.8μH	±20%	0.098±20%	1200	1400
24	LQH43PN8R2M26	10	8.2μH	±20%	0.128±20%	1100	1300
25	LQH43PN100M26	10	10μH	±20%	0.147±20%	1050	1170
26	LQH43PN220M26	10	22μH	±20%	0.327±20%	700	780
27	LQH43PN470M26	10	47μH	±20%	0.718±20%	470	520
28	LQH43PN101M26	10	100μH	±20%	1.538±20%	320	320
29	LQH43PN151M26	10	150μH	±20%	2.362±20%	280	260
30	LQH43PN221M26	10	220μH	±20%	2.900±20%	220	240

● EKLQMH5PC-KIT (Inductors for Power Lines: Wire Wound Type)

No.	Part Number	Quantity (pcs.)	Inductance		DC Resistance (Ω)	Rated Current (mA)	
			Nominal	Tolerance		Based on Inductance Change	Based on Temperature Rise
1	LQH5BPNR47NT0	10	0.47μH	±30%	0.012±20%	7700	4000
2	LQH5BPN1R0NT0	10	1.0μH	±30%	0.019±20%	5800	3100
3	LQH5BPN1R2NT0	10	1.2μH	±30%	0.019±20%	5400	3100
4	LQH5BPN1R5NT0	10	1.5μH	±30%	0.024±20%	5000	3000
5	LQH5BPN2R2NT0	10	2.2μH	±30%	0.030±20%	4000	2600
6	LQH5BPN2R7NT0	10	2.7μH	±30%	0.035±20%	3800	2500
7	LQH5BPN3R3NT0	10	3.3μH	±30%	0.044±20%	3500	2300
8	LQH5BPN4R7NT0	10	4.7μH	±30%	0.058±20%	3000	2000
9	LQH5BPN6R8NT0	10	6.8μH	±30%	0.083±20%	2500	1650
10	LQH5BPN100MT0	10	10μH	±20%	0.106±20%	2000	1600
11	LQH5BPN150MT0	10	15μH	±20%	0.187±20%	1600	1200
12	LQH5BPN220MT0	10	22μH	±20%	0.259±20%	1400	1050

● EKLQMH32CC-KIT (Inductors for Power Lines: Wire Wound Type)

No.	Part Number	Quantity (pcs.)	Inductance		DC Resistance (Ω)	Rated Current (mA)
			Nominal	Tolerance		
1	LQH32CNR15M33	10	0.15μH	±20%	0.028±30%	1450
2	LQH32CNR27M33	10	0.27μH	±20%	0.034±30%	1250
3	LQH32CNR47M33	10	0.47μH	±20%	0.042±30%	1100
4	LQH32CN1R0M33	10	1.0μH	±20%	0.06±30%	1000
5	LQH32CN2R2M33	10	2.2μH	±20%	0.097±30%	790
6	LQH32CN4R7M33	10	4.7μH	±20%	0.15±30%	650
7	LQH32CN100K33	10	10μH	±10%	0.3±30%	450
8	LQH32CN1R0M23	10	1.0μH	±20%	0.09±30%	800
9	LQH32CN2R2M23	10	2.2μH	±20%	0.13±30%	600
10	LQH32CN4R7M23	10	4.7μH	±20%	0.2±30%	450
11	LQH32CN100K23	10	10μH	±10%	0.44±30%	300
12	LQH32CN220K23	10	22μH	±10%	0.71±30%	250
13	LQH32CN470K23	10	47μH	±10%	1.3±30%	170
14	LQH32CN101K23	10	100μH	±10%	3.5±30%	100
15	LQH32CN221K23	10	220μH	±10%	8.4±30%	70
16	LQH32CN331K23	10	330μH	±10%	10±30%	60
17	LQH32CN391K23	10	390μH	±10%	17±30%	60
18	LQH32CN471K23	10	470μH	±10%	19±30%	60
19	LQH32CN561K23	10	560μH	±10%	22±30%	60
20	LQH32CN1R0M53	10	1.0μH	±20%	0.06±30%	1000
21	LQH32CN2R2M53	10	2.2μH	±20%	0.097±30%	790
22	LQH32CN4R7M53	10	4.7μH	±20%	0.15±30%	650
23	LQH32CN100K53	10	10μH	±10%	0.3±30%	450
24	LQH32CN150K53	10	15μH	±10%	0.58±30%	300
25	LQH32CN220K53	10	22μH	±10%	0.71±30%	250
26	LQH32CN330K53	10	33μH	±10%	1.1±30%	200
27	LQH32CN470K53	10	47μH	±10%	1.3±30%	170

Continued on the following page. ↗

⚠ Note • Please read rating and ⚠ CAUTION (for storage, operating, rating, soldering, mounting and handling) in this catalog to prevent smoking and/or burning, etc.
 • This catalog has only typical specifications. Therefore, please approve our product specifications or transact the approval sheet for product specifications before ordering.

Continued from the preceding page.

No.	Part Number	Quantity (pcs.)	Inductance		DC Resistance (Ω)	Rated Current (mA)
			Nominal	Tolerance		
28	LQH32CN680K53	10	68μH	±10%	2.2±30%	130
29	LQH32CN101K53	10	100μH	±10%	3.5±30%	100

●EKL43CD-KIT (Inductors for Power Lines: Wire Wound Type)

No.	Part Number	Quantity (pcs.)	Inductance		DC Resistance (Ω) max.	Rated Current (mA)
			Nominal	Tolerance		
1	LQH43CN1R0M03	10	1.0μH	±20%	0.08	1080
2	LQH43CN1R5M03	10	1.5μH	±20%	0.09	1000
3	LQH43CN2R2M03	10	2.2μH	±20%	0.11	900
4	LQH43CN3R3M03	10	3.3μH	±20%	0.13	800
5	LQH43CN4R7M03	10	4.7μH	±20%	0.15	750
6	LQH43CN6R8M03	10	6.8μH	±20%	0.20	720
7	LQH43CN100K03	10	10μH	±10%	0.24	650
8	LQH43CN150K03	10	15μH	±10%	0.32	570
9	LQH43CN220K03	10	22μH	±10%	0.60	420
10	LQH43CN330K03	10	33μH	±10%	1.00	310
11	LQH43CN470K03	10	47μH	±10%	1.10	280
12	LQH43CN680K03	10	68μH	±10%	1.70	220
13	LQH43CN101K03	10	100μH	±10%	2.20	190
14	LQH43CN151K03	10	150μH	±10%	3.50	130
15	LQH43CN221K03	10	220μH	±10%	4.00	110
16	LQH43CN331K03	10	330μH	±10%	6.80	100
17	LQH43CN471K03	10	470μH	±10%	8.50	90
18	LQH43CNR56M33	10	0.56μH	±20%	0.030	2950
19	LQH43CNR82M33	10	0.82μH	±20%	0.036	2800
20	LQH43CN1R0M33	10	1.0μH	±20%	0.042	2600
21	LQH43CN1R5M33	10	1.5μH	±20%	0.047	2450
22	LQH43CN1R8M33	10	1.8μH	±20%	0.055	2300
23	LQH43CN2R2M33	10	2.2μH	±20%	0.062	2100
24	LQH43CN2R7M33	10	2.7μH	±20%	0.069	1800
25	LQH43CN3R3M33	10	3.3μH	±20%	0.099	1650
26	LQH43CN3R9M33	10	3.9μH	±20%	0.107	1600

●EKL18CC-KIT (Inductors for Power Lines: Wire Wound Type)

No.	Part Number	Quantity (pcs.)	Inductance		DC Resistance (Ω) max.	Rated Current (mA)
			Nominal	Tolerance		
1	LQW15CN18NJ00	10	18nH	±5%	0.046	1400
2	LQW15CN33NJ00	10	33nH	±5%	0.065	1300
3	LQW15CN48NJ00	10	48nH	±5%	0.078	1100
4	LQW15CN70NJ00	10	70nH	±5%	0.12	820
5	LQW15CN96NJ00	10	96nH	±5%	0.16	730
6	LQW15CNR13J00	10	130nH	±5%	0.23	640
7	LQW15CNR16J00	10	160nH	±5%	0.33	480
8	LQW15CNR20J00	10	200nH	±5%	0.47	390
9	LQW15CNR39K10	10	390nH	±10%	0.62	370
10	LQW15CNR56K10	10	560nH	±10%	0.71	300
11	LQW18CN4N9D00	10	4.9nH	±0.5nH	0.015	2600
12	LQW18CN15NJ00	10	15nH	±5%	0.025	2200
13	LQW18CN33NJ00	10	33nH	±5%	0.035	1700
14	LQW18CN55NJ00	10	55nH	±5%	0.045	1500
15	LQW18CN85NJ00	10	85nH	±5%	0.060	1400
16	LQW18CNR10K00	10	100nH	±10%	0.10	1000
17	LQW18CNR12J00	10	120nH	±5%	0.085	1100
18	LQW18CNR16J00	10	160nH	±5%	0.10	1000
19	LQW18CNR21J00	10	210nH	±5%	0.15	800
20	LQW18CNR27J00	10	270nH	±5%	0.16	750
21	LQW18CNR33J00	10	330nH	±5%	0.25	630
22	LQW18CNR39J00	10	390nH	±5%	0.28	620
23	LQW18CNR47J00	10	470nH	±5%	0.45	500
24	LQW18CNR56J00	10	560nH	±5%	0.48	450
25	LQW18CNR65J00	10	650nH	±5%	0.52	430

△Note • Please read rating and △CAUTION (for storage, operating, rating, soldering, mounting and handling) in this catalog to prevent smoking and/or burning, etc.
 • This catalog has only typical specifications. Therefore, please approve our product specifications or transact the approval sheet for product specifications before ordering.

● Inductors for General Use

Part Numbering	118
Product Detail	119
⚠Caution/Notice	136
Soldering and Mounting	137
Packaging	141
Design Kits	142

Inductors for General Use Part Numbering

(Part Number) **LQ M 18 N N 47N M 0 0 D**
 ① ② ③ ④ ⑤ ⑥ ⑦ ⑧ ⑨ ⑩

① Product ID

Product ID	
LQ	Chip Inductors (Chip Coils)

② Structure

Code	Structure
B	Multilayer Type (Ferrite Core)
H	Wire Wound Type (Ferrite Core)
M	Multilayer Type (Ferrite Core)

③ Dimensions (L×W)

Code	Dimensions (L×W)	Size Code (in inch)
15	1.0×0.5mm	0402
18	1.6×0.8mm	0603
21	2.0×1.25mm	0805
31	3.2×1.6mm	1206
32	3.2×2.5mm	1210
43	4.5×3.2mm	1812
44	4.0×4.0mm	1515

④ Applications and Characteristics

Code	Series	Applications and Characteristics
N	LQB/LQM	for Resonant Circuit
N	LQH	for Resonant Circuit
M		for Resonant Circuit (Coating Type)

⑤ Category

Code	Category
N	Standard Type

⑩ Packaging

Code	Packaging	Series
K	Embossed Taping (ø330mm Reel)	LQH/LQM21*1
L	Embossed Taping (ø180mm Reel)	LQH/LQM21*1
B	Bulk	LQB/LQM
J	Paper Taping (ø330mm Reel)	LQB/LQM18/LQM21*2
D	Paper Taping (ø180mm Reel)	LQB/LQM18/LQM21*2

*1 LQM21N(2.7 - 4.7μH) only.

*2 LQM21N(0.1 - 2.2μH) only.

⑥ Inductance

Expressed by three-digit alphanumeric. The unit is micro-henry (μH). The first and second figures are significant digits, and the third figure expresses the number of zeros that follow the two figures. If there is a decimal point, it is expressed by the capital letter "R". In this case, all figures are significant digits. If inductance is less than 0.1μH, the inductance code is expressed by a combination of two figures and the capital letter "N", and the unit of inductance is nano-henry (nH). The capital letter "N" indicates the unit of "nH", and also expresses a decimal point. In this case, all figures are significant digits.

⑦ Inductance Tolerance

Code	Inductance Tolerance
J	±5%
K	±10%
M	±20%
N	±30%

⑧ Features

Code	Features	Series
0	Standard Type	LQM*1 /LQH*2
1	Standard Type	LQB/LQM21N
2	Standard Type	LQH32M

*1 Except for LQM21N Series

*2 Except for LQH32 Series

⑨ Electrode

•Lead (Pb) Free

Code	Electrode	Series
0	Sn	LQB/LQM
3	LF Solder	LQH

△Note • Please read rating and CAUTION (for storage, operating, rating, soldering, mounting and handling) in this catalog to prevent smoking and/or burning, etc.
 • This catalog has only typical specifications. Therefore, please approve our product specifications or transact the approval sheet for product specifications before ordering.

LQB15NN_10

Series 0402/1005 (inch/mm)

For Near Field Communication, Matching, Choke

Appearance/Dimensions

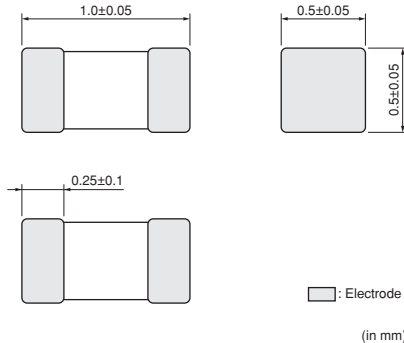

Packaging

Code	Packaging	Minimum Quantity
D	ø180mm Paper Taping	10000
J	ø330mm Paper Taping	50000
B	Packing in Bulk	1000



Refer to pages 137 to 140 for mounting information.

Rated Value (□: packaging code)

Part Number	Inductance	Inductance Test Frequency	Rated Current ^{*1}	DC Resistance	Q (min.)	Q Test Frequency	Self-Resonance Frequency (min.)	
LQB15NNR22J10□	220nH ±5%	25MHz	380mA	0.35Ω ±25%	10	25MHz	80MHz	New
LQB15NNR22K10□	220nH ±10%	25MHz	380mA	0.35Ω ±25%	10	25MHz	80MHz	New
LQB15NNR22M10□	220nH ±20%	25MHz	380mA	0.35Ω ±25%	10	25MHz	80MHz	New
LQB15NNR27J10□	270nH ±5%	25MHz	330mA	0.41Ω ±25%	10	25MHz	80MHz	New
LQB15NNR27K10□	270nH ±10%	25MHz	330mA	0.41Ω ±25%	10	25MHz	80MHz	New
LQB15NNR27M10□	270nH ±20%	25MHz	330mA	0.41Ω ±25%	10	25MHz	80MHz	New
LQB15NNR33J10□	330nH ±5%	25MHz	300mA	0.48Ω ±25%	10	25MHz	80MHz	New
LQB15NNR33K10□	330nH ±10%	25MHz	300mA	0.48Ω ±25%	10	25MHz	80MHz	New
LQB15NNR33M10□	330nH ±20%	25MHz	300mA	0.48Ω ±25%	10	25MHz	80MHz	New
LQB15NNR39J10□	390nH ±5%	25MHz	300mA	0.54Ω ±25%	10	25MHz	80MHz	New
LQB15NNR39K10□	390nH ±10%	25MHz	300mA	0.54Ω ±25%	10	25MHz	80MHz	New
LQB15NNR39M10□	390nH ±20%	25MHz	300mA	0.54Ω ±25%	10	25MHz	80MHz	New
LQB15NNR47J10□	470nH ±5%	25MHz	300mA	0.64Ω ±25%	10	25MHz	80MHz	New
LQB15NNR47K10□	470nH ±10%	25MHz	300mA	0.64Ω ±25%	10	25MHz	80MHz	New
LQB15NNR47M10□	470nH ±20%	25MHz	300mA	0.64Ω ±25%	10	25MHz	80MHz	New
LQB15NNR56J10□	560nH ±5%	25MHz	300mA	0.73Ω ±25%	10	25MHz	80MHz	New
LQB15NNR56K10□	560nH ±10%	25MHz	300mA	0.73Ω ±25%	10	25MHz	80MHz	New
LQB15NNR56M10□	560nH ±20%	25MHz	300mA	0.73Ω ±25%	10	25MHz	80MHz	New

Class of Magnetic Shield: Magnetic shield of ferrite

Operating Temperature Range: -55°C~+125°C

For reflow soldering only.

*1 When rated current is applied to the products, self-generation of heat will rise to 25°C or less.

Continued on the following page.

■ Q-Frequency Characteristics (Typ.)

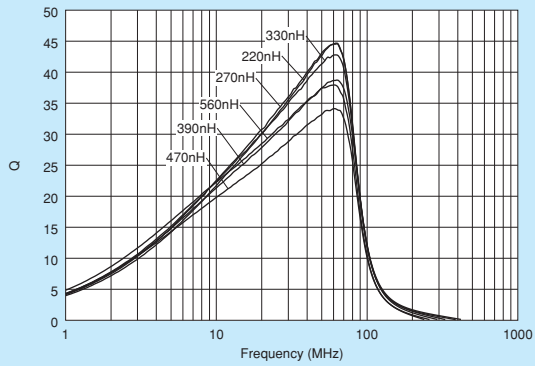

■ Inductance-Current Characteristics (Typ.)

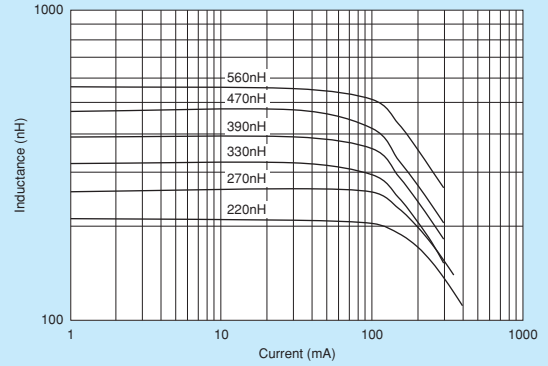

⚠Note • Please read rating and ⚠CAUTION (for storage, operating, rating, soldering, mounting and handling) in this catalog to prevent smoking and/or burning, etc.
• This catalog has only typical specifications. Therefore, please approve our product specifications or transact the approval sheet for product specifications before ordering.

LQB18NN_10

Series 0603/1608 (inch/mm)

For Near Field Communication, Matching, Choke

Appearance/Dimensions

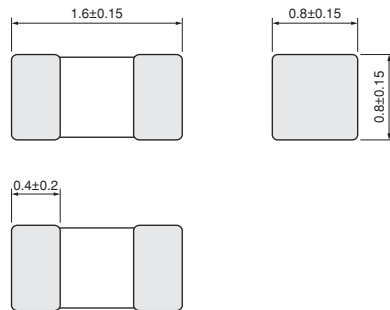

(in mm)

Packaging

Code	Packaging	Minimum Quantity
D	ø180mm Paper Taping	4000
B	Packing in Bulk	1000



Refer to pages 137 to 140 for mounting information.

Rated Value (□: packaging code)

Part Number	Inductance	Inductance Test Frequency	Rated Current	Max. of DC Resistance	Q (min.)	Q Test Frequency	Self-Resonance Frequency (min.)	
LQB18NNR22J10□	220nH ±5%	25MHz	450mA	0.37Ω	25	25MHz	80MHz	New
LQB18NNR22K10□	220nH ±10%	25MHz	450mA	0.37Ω	25	25MHz	80MHz	New
LQB18NNR22M10□	220nH ±20%	25MHz	450mA	0.37Ω	25	25MHz	80MHz	New
LQB18NNR22N10□	220nH ±30%	25MHz	450mA	0.37Ω	25	25MHz	80MHz	New
LQB18NNR27J10□	270nH ±5%	25MHz	450mA	0.45Ω	25	25MHz	80MHz	New
LQB18NNR27K10□	270nH ±10%	25MHz	450mA	0.45Ω	25	25MHz	80MHz	New
LQB18NNR27M10□	270nH ±20%	25MHz	450mA	0.45Ω	25	25MHz	80MHz	New
LQB18NNR27N10□	270nH ±30%	25MHz	450mA	0.45Ω	25	25MHz	80MHz	New
LQB18NNR33J10□	330nH ±5%	25MHz	450mA	0.45Ω	25	25MHz	80MHz	New
LQB18NNR33K10□	330nH ±10%	25MHz	450mA	0.45Ω	25	25MHz	80MHz	New
LQB18NNR33M10□	330nH ±20%	25MHz	450mA	0.45Ω	25	25MHz	80MHz	New
LQB18NNR33N10□	330nH ±30%	25MHz	450mA	0.45Ω	25	25MHz	80MHz	New
LQB18NNR39J10□	390nH ±5%	25MHz	450mA	0.58Ω	25	25MHz	80MHz	New
LQB18NNR39K10□	390nH ±10%	25MHz	450mA	0.58Ω	25	25MHz	80MHz	New
LQB18NNR39M10□	390nH ±20%	25MHz	450mA	0.58Ω	25	25MHz	80MHz	New
LQB18NNR39N10□	390nH ±30%	25MHz	450mA	0.58Ω	25	25MHz	80MHz	New
LQB18NNR47J10□	470nH ±5%	25MHz	400mA	0.58Ω	25	25MHz	80MHz	New
LQB18NNR47K10□	470nH ±10%	25MHz	400mA	0.58Ω	25	25MHz	80MHz	New
LQB18NNR47M10□	470nH ±20%	25MHz	400mA	0.58Ω	25	25MHz	80MHz	New
LQB18NNR47N10□	470nH ±30%	25MHz	400mA	0.58Ω	25	25MHz	80MHz	New
LQB18NNR56J10□	560nH ±5%	25MHz	300mA	0.85Ω	25	25MHz	80MHz	New
LQB18NNR56K10□	560nH ±10%	25MHz	300mA	0.85Ω	25	25MHz	80MHz	New
LQB18NNR56M10□	560nH ±20%	25MHz	300mA	0.85Ω	25	25MHz	80MHz	New
LQB18NNR56N10□	560nH ±30%	25MHz	300mA	0.85Ω	25	25MHz	80MHz	New

Class of Magnetic Shield: Magnetic shield of ferrite
 Operating Temperature Range: -55°C~+125°C

Continued on the following page.

■ Q-Frequency Characteristics (Typ.)

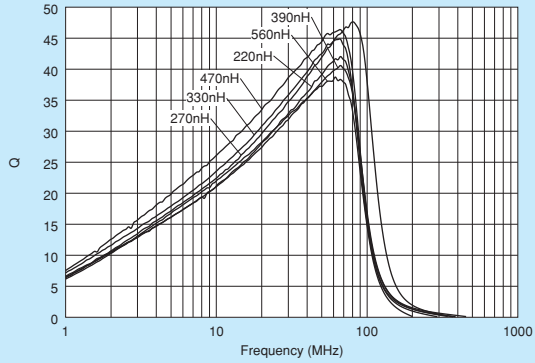

■ Inductance-Current Characteristics (Typ.)

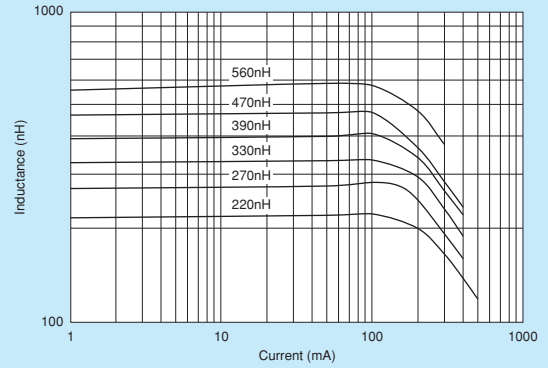

⚠Note • Please read rating and ⚠CAUTION (for storage, operating, rating, soldering, mounting and handling) in this catalog to prevent smoking and/or burning, etc.
• This catalog has only typical specifications. Therefore, please approve our product specifications or transact the approval sheet for product specifications before ordering.

LQM18NN_00 Series 0603/1608 (inch/mm)

Size Code 0603 (1608) in inch (in mm)

Appearance/Dimensions

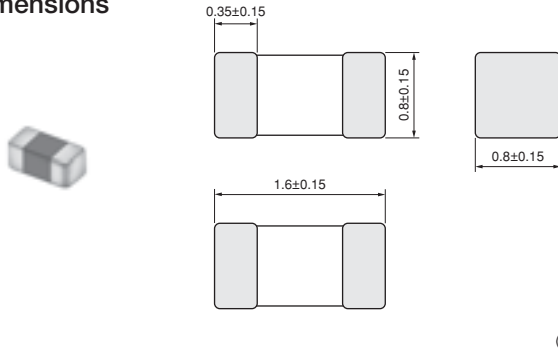

Packaging

Code	Packaging	Minimum Quantity
D	ø180mm Paper Taping	4000
J	ø330mm Paper Taping	10000
B	Packing in Bulk	1000



Refer to pages 137 to 140 for mounting information.

Rated Value (□: packaging code)

Part Number	Inductance	Inductance Test Frequency	Rated Current	Max. of DC Resistance	Q (min.)	Q Test Frequency	Self-Resonance Frequency (min.)	
LQM18NN47NM00□	47nH ±20%	50MHz	50mA	0.30Ω	10	50MHz	260MHz	Kit
LQM18NN68NM00□	68nH ±20%	50MHz	50mA	0.30Ω	10	50MHz	250MHz	Kit
LQM18NN82NM00□	82nH ±20%	50MHz	50mA	0.30Ω	10	50MHz	245MHz	Kit
LQM18NNR10K00□	100nH ±10%	25MHz	50mA	0.50Ω	15	25MHz	240MHz	Kit
LQM18NNR12K00□	120nH ±10%	25MHz	50mA	0.50Ω	15	25MHz	205MHz	Kit
LQM18NNR15K00□	150nH ±10%	25MHz	50mA	0.60Ω	15	25MHz	180MHz	Kit
LQM18NNR18K00□	180nH ±10%	25MHz	50mA	0.60Ω	15	25MHz	165MHz	Kit
LQM18NNR22K00□	220nH ±10%	25MHz	50mA	0.80Ω	15	25MHz	150MHz	Kit
LQM18NNR27K00□	270nH ±10%	25MHz	50mA	0.80Ω	15	25MHz	136MHz	Kit
LQM18NNR33K00□	330nH ±10%	25MHz	35mA	0.85Ω	15	25MHz	125MHz	Kit
LQM18NNR39K00□	390nH ±10%	25MHz	35mA	1.00Ω	15	25MHz	110MHz	Kit
LQM18NNR47K00□	470nH ±10%	25MHz	35mA	1.35Ω	15	25MHz	105MHz	Kit
LQM18NNR56K00□	560nH ±10%	25MHz	35mA	1.55Ω	15	25MHz	95MHz	Kit
LQM18NNR68K00□	680nH ±10%	25MHz	35mA	1.70Ω	15	25MHz	90MHz	Kit
LQM18NNR82K00□	820nH ±10%	25MHz	35mA	2.10Ω	15	25MHz	85MHz	Kit
LQM18NN1R0K00□	1000nH ±10%	10MHz	25mA	0.60Ω	35	10MHz	75MHz	Kit
LQM18NN1R2K00□	1200nH ±10%	10MHz	25mA	0.80Ω	35	10MHz	65MHz	Kit
LQM18NN1R5K00□	1500nH ±10%	10MHz	25mA	0.80Ω	35	10MHz	60MHz	Kit
LQM18NN1R8K00□	1800nH ±10%	10MHz	25mA	0.95Ω	35	10MHz	55MHz	Kit
LQM18NN2R2K00□	2200nH ±10%	10MHz	15mA	1.15Ω	35	10MHz	50MHz	Kit

Class of Magnetic Shield: Magnetic shield of ferrite
 Operating Temperature Range (Self-temperature rise is not included): -40°C~+85°C

Continued on the following page. ↗

Note • Please read rating and CAUTION (for storage, operating, rating, soldering, mounting and handling) in this catalog to prevent smoking and/or burning, etc.
 • This catalog has only typical specifications. Therefore, please approve our product specifications or transact the approval sheet for product specifications before ordering.

■ Q-Frequency Characteristics (Typ.)

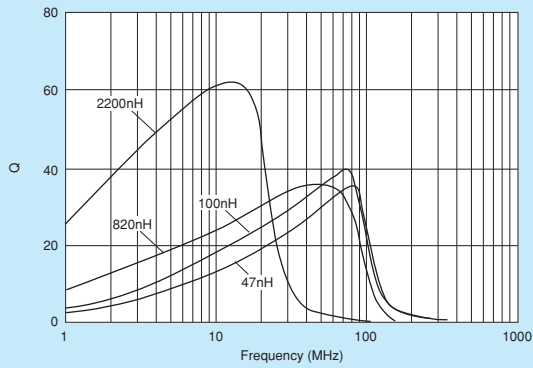

■ Inductance-Current Characteristics (Typ.)

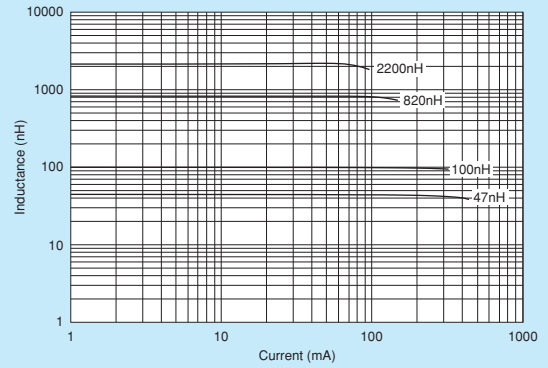

⚠Note • Please read rating and ⚠CAUTION (for storage, operating, rating, soldering, mounting and handling) in this catalog to prevent smoking and/or burning, etc.
• This catalog has only typical specifications. Therefore, please approve our product specifications or transact the approval sheet for product specifications before ordering.

LQM21NN_10 Series 0805/2012 (inch/mm)

Size Code 0805 (2012) in inch (in mm)

Appearance/Dimensions

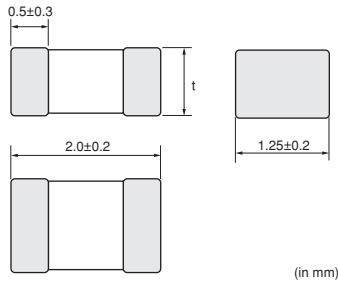

Dimension of t	Inductance: 0.1 to 2.2μH	0.85±0.2
	Inductance: 2.7 to 4.7μH	1.25±0.2

Packaging

Code	Packaging	Minimum Quantity
D	ø180mm Paper Taping	4000
L	ø180mm Embossed Taping	3000
J	ø330mm Paper Taping	10000
K	ø330mm Embossed Taping	10000
B	Packing in Bulk	1000



Refer to pages 137 to 140 for mounting information.

Rated Value (□: packaging code)

Part Number	Inductance	Inductance Test Frequency	Rated Current	Max. of DC Resistance	Q (min.)	Q Test Frequency	Self-Resonance Frequency (min.)	
LQM21NNR10K10□	0.1μH ±10%	25MHz	250mA	0.26Ω	20	25MHz	340MHz	Kit
LQM21NNR12K10□	0.12μH ±10%	25MHz	250mA	0.29Ω	20	25MHz	310MHz	Kit
LQM21NNR15K10□	0.15μH ±10%	25MHz	250mA	0.32Ω	20	25MHz	270MHz	Kit
LQM21NNR18K10□	0.18μH ±10%	25MHz	250mA	0.35Ω	20	25MHz	250MHz	Kit
LQM21NNR22K10□	0.22μH ±10%	25MHz	250mA	0.38Ω	20	25MHz	220MHz	Kit
LQM21NNR27K10□	0.27μH ±10%	25MHz	250mA	0.42Ω	20	25MHz	200MHz	Kit
LQM21NNR33K10□	0.33μH ±10%	25MHz	250mA	0.48Ω	20	25MHz	180MHz	Kit
LQM21NNR39K10□	0.39μH ±10%	25MHz	200mA	0.53Ω	25	25MHz	165MHz	Kit
LQM21NNR47K10□	0.47μH ±10%	25MHz	200mA	0.57Ω	25	25MHz	150MHz	Kit
LQM21NNR56K10□	0.56μH ±10%	25MHz	150mA	0.63Ω	25	25MHz	140MHz	Kit
LQM21NNR68K10□	0.68μH ±10%	25MHz	150mA	0.72Ω	25	25MHz	125MHz	Kit
LQM21NNR82K10□	0.82μH ±10%	25MHz	150mA	0.81Ω	25	25MHz	115MHz	Kit
LQM21NN1R0K10□	1.0μH ±10%	10MHz	50mA	0.40Ω	45	10MHz	107MHz	Kit
LQM21NN1R2K10□	1.2μH ±10%	10MHz	50mA	0.47Ω	45	10MHz	97MHz	Kit
LQM21NN1R5K10□	1.5μH ±10%	10MHz	50mA	0.50Ω	45	10MHz	87MHz	Kit
LQM21NN1R8K10□	1.8μH ±10%	10MHz	50mA	0.57Ω	45	10MHz	80MHz	Kit
LQM21NN2R2K10□	2.2μH ±10%	10MHz	30mA	0.63Ω	45	10MHz	71MHz	Kit
LQM21NN2R7K10□	2.7μH ±10%	10MHz	30mA	0.69Ω	45	10MHz	66MHz	Kit
LQM21NN3R3K10□	3.3μH ±10%	10MHz	30mA	0.80Ω	45	10MHz	59MHz	Kit
LQM21NN3R9K10□	3.9μH ±10%	10MHz	30mA	0.89Ω	45	10MHz	53MHz	Kit
LQM21NN4R7K10□	4.7μH ±10%	10MHz	30mA	1.00Ω	45	10MHz	47MHz	Kit

Class of Magnetic Shield: Magnetic shield of ferrite
 Operating Temperature Range (Self-temperature rise is not included): -40°C~+85°C

Continued on the following page. ↗

Note • Please read rating and CAUTION (for storage, operating, rating, soldering, mounting and handling) in this catalog to prevent smoking and/or burning, etc.
 • This catalog has only typical specifications. Therefore, please approve our product specifications or transact the approval sheet for product specifications before ordering.

■ Q-Frequency Characteristics (Typ.)

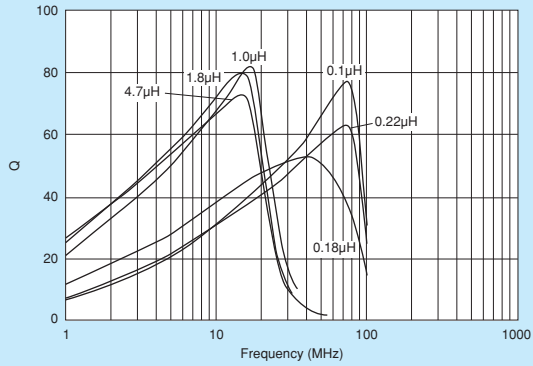

■ Inductance-Current Characteristics (Typ.)

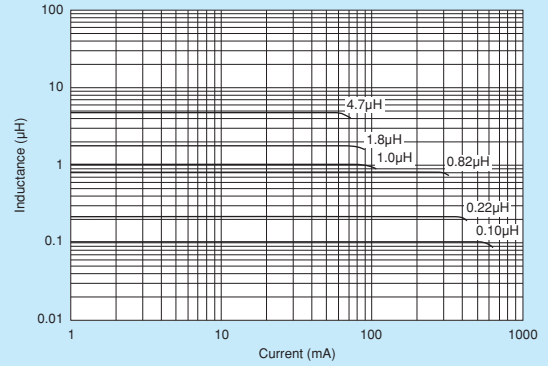

⚠Note • Please read rating and ⚠CAUTION (for storage, operating, rating, soldering, mounting and handling) in this catalog to prevent smoking and/or burning, etc.
• This catalog has only typical specifications. Therefore, please approve our product specifications or transact the approval sheet for product specifications before ordering.

LQH31MN_03 Series 1206/3216 (inch/mm)

Size Code 1206 (3216) in inch (in mm)

Appearance/Dimensions

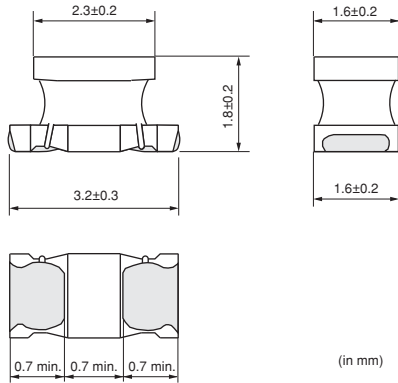

Packaging

Code	Packaging	Minimum Quantity
L	ø180mm Embossed Taping	2000
K	ø330mm Embossed Taping	7500



Refer to pages 137 to 140 for mounting information.

Rated Value (□: packaging code)

Part Number	Inductance	Inductance Test Frequency	Rated Current ^{*1}	DC Resistance	Q (min.)	Q Test Frequency	Self-Resonance Frequency (min.)
LQH31MNR15K03□	0.15µH ±10%	1MHz	250mA	0.39 Ω ±40%	20	25.2MHz	250MHz
LQH31MNR22K03□	0.22µH ±10%	1MHz	240mA	0.43 Ω ±40%	20	25.2MHz	250MHz
LQH31MNR33K03□	0.33µH ±10%	1MHz	230mA	0.45 Ω ±40%	30	25.2MHz	250MHz
LQH31MNR47K03□	0.47µH ±10%	1MHz	215mA	0.83 Ω ±40%	30	25.2MHz	200MHz
LQH31MNR56K03□	0.56µH ±10%	1MHz	200mA	0.61 Ω ±40%	30	25.2MHz	180MHz
LQH31MNR68K03□	0.68µH ±10%	1MHz	190mA	0.67 Ω ±40%	30	25.2MHz	160MHz
LQH31MNR82K03□	0.82µH ±10%	1MHz	185mA	0.73 Ω ±40%	30	25.2MHz	120MHz
LQH31MN1R0K03□	1.0µH ±10%	1MHz	175mA	0.49 Ω ±30%	35	10MHz	100MHz
LQH31MN1R2J03□	1.2µH ±5%	1MHz	165mA	0.37 Ω ±30%	35	10MHz	90MHz
LQH31MN1R2K03□	1.2µH ±10%	1MHz	165mA	0.9 Ω ±30%	35	10MHz	90MHz
LQH31MN1R5J03□	1.5µH ±5%	1MHz	155mA	1.0 Ω ±30%	35	10MHz	75MHz
LQH31MN1R5K03□	1.5µH ±10%	1MHz	155mA	1.0 Ω ±30%	35	10MHz	75MHz
LQH31MN1R8J03□	1.8µH ±5%	1MHz	150mA	1.6 Ω ±30%	35	10MHz	60MHz
LQH31MN1R8K03□	1.8µH ±10%	1MHz	150mA	1.6 Ω ±30%	35	10MHz	60MHz
LQH31MN2R2J03□	2.2µH ±5%	1MHz	140mA	0.7 Ω ±30%	35	10MHz	50MHz
LQH31MN2R2K03□	2.2µH ±10%	1MHz	140mA	0.7 Ω ±30%	35	10MHz	50MHz
LQH31MN2R7J03□	2.7µH ±5%	1MHz	135mA	0.55 Ω ±30%	35	10MHz	43MHz
LQH31MN2R7K03□	2.7µH ±10%	1MHz	135mA	0.55 Ω ±30%	35	10MHz	43MHz
LQH31MN3R3J03□	3.3µH ±5%	1MHz	130mA	0.61 Ω ±30%	35	8MHz	38MHz
LQH31MN3R3K03□	3.3µH ±10%	1MHz	130mA	0.61 Ω ±30%	35	8MHz	38MHz
LQH31MN3R9J03□	3.9µH ±5%	1MHz	125mA	1.5 Ω ±30%	35	8MHz	35MHz
LQH31MN3R9K03□	3.9µH ±10%	1MHz	125mA	1.5 Ω ±30%	35	8MHz	35MHz
LQH31MN4R7J03□	4.7µH ±5%	1MHz	120mA	1.7 Ω ±30%	35	8MHz	31MHz
LQH31MN4R7K03□	4.7µH ±10%	1MHz	120mA	1.7 Ω ±30%	35	8MHz	31MHz
LQH31MN5R6J03□	5.6µH ±5%	1MHz	115mA	1.8 Ω ±30%	35	8MHz	28MHz
LQH31MN5R6K03□	5.6µH ±10%	1MHz	115mA	1.8 Ω ±30%	35	8MHz	28MHz
LQH31MN6R8J03□	6.8µH ±5%	1MHz	110mA	2.0 Ω ±30%	35	8MHz	25MHz
LQH31MN6R8K03□	6.8µH ±10%	1MHz	110mA	2.0 Ω ±30%	35	8MHz	25MHz
LQH31MN8R2J03□	8.2µH ±5%	1MHz	105mA	2.2 Ω ±30%	35	8MHz	23MHz
LQH31MN8R2K03□	8.2µH ±10%	1MHz	105mA	2.2 Ω ±30%	35	8MHz	23MHz
LQH31MN100J03□	10µH ±5%	1MHz	100mA	2.5 Ω ±30%	35	5MHz	20MHz
LQH31MN100K03□	10µH ±10%	1MHz	100mA	2.5 Ω ±30%	35	5MHz	20MHz

Class of Magnetic Shield: No magnetic shield

Operating Temperature Range (Self-temperature rise is not included): -40°C~+85°C

*1 When applied rated current to the products, self-temperature rise shall be limited to 20°C max. and inductance will be within ±10% of initial inductance value.

Continued on the following page.

[△]Note • Please read rating and [△]CAUTION (for storage, operating, rating, soldering, mounting and handling) in this catalog to prevent smoking and/or burning, etc.
• This catalog has only typical specifications. Therefore, please approve our product specifications or transact the approval sheet for product specifications before ordering.

Part Number	Inductance	Inductance Test Frequency	Rated Current ^{*1}	DC Resistance	Q (min.)	Q Test Frequency	Self-Resonance Frequency (min.)
LQH31MN120J03□	12μH ±5%	1MHz	95mA	2.7Ω ±30%	35	5MHz	18MHz
LQH31MN120K03□	12μH ±10%	1MHz	95mA	2.7Ω ±30%	35	5MHz	18MHz
LQH31MN150J03□	15μH ±5%	1MHz	90mA	3.0Ω ±30%	35	5MHz	16MHz
LQH31MN150K03□	15μH ±10%	1MHz	90mA	3.0Ω ±30%	35	5MHz	16MHz
LQH31MN180J03□	18μH ±5%	1MHz	85mA	3.4Ω ±30%	35	5MHz	15MHz
LQH31MN180K03□	18μH ±10%	1MHz	85mA	3.4Ω ±30%	35	5MHz	15MHz
LQH31MN220J03□	22μH ±5%	1MHz	85mA	3.1Ω ±30%	40	2.5MHz	14MHz
LQH31MN220K03□	22μH ±10%	1MHz	85mA	3.1Ω ±30%	40	2.5MHz	14MHz
LQH31MN270J03□	27μH ±5%	1MHz	85mA	3.4Ω ±30%	40	2.5MHz	13MHz
LQH31MN270K03□	27μH ±10%	1MHz	85mA	3.4Ω ±30%	40	2.5MHz	13MHz
LQH31MN330J03□	33μH ±5%	1MHz	80mA	3.8Ω ±30%	40	2.5MHz	12MHz
LQH31MN330K03□	33μH ±10%	1MHz	80mA	3.8Ω ±30%	40	2.5MHz	12MHz
LQH31MN390J03□	39μH ±5%	1MHz	55mA	7.2Ω ±30%	40	2.5MHz	11MHz
LQH31MN390K03□	39μH ±10%	1MHz	55mA	7.2Ω ±30%	40	2.5MHz	11MHz
LQH31MN470J03□	47μH ±5%	1MHz	55mA	8.0Ω ±30%	40	2.5MHz	10MHz
LQH31MN470K03□	47μH ±10%	1MHz	55mA	8.0Ω ±30%	40	2.5MHz	10MHz
LQH31MN560J03□	56μH ±5%	1MHz	50mA	8.9Ω ±30%	40	2.5MHz	9MHz
LQH31MN560K03□	56μH ±10%	1MHz	50mA	8.9Ω ±30%	40	2.5MHz	9MHz
LQH31MN680J03□	68μH ±5%	1MHz	50mA	9.9Ω ±30%	40	2.5MHz	8.5MHz
LQH31MN680K03□	68μH ±10%	1MHz	50mA	9.9Ω ±30%	40	2.5MHz	8.5MHz
LQH31MN820J03□	82μH ±5%	1MHz	45mA	11.0Ω ±30%	40	2.5MHz	7.5MHz
LQH31MN820K03□	82μH ±10%	1MHz	45mA	11.0Ω ±30%	40	2.5MHz	7.5MHz
LQH31MN101J03□	100μH ±5%	1MHz	45mA	12.0Ω ±30%	40	2.5MHz	7MHz
LQH31MN101K03□	100μH ±10%	1MHz	45mA	12.0Ω ±30%	40	2.5MHz	7MHz

Class of Magnetic Shield: No magnetic shield

Operating Temperature Range (Self-temperature rise is not included): -40°C~+85°C

*1 When applied rated current to the products, self-temperature rise shall be limited to 20°C max. and inductance will be within ±10% of initial inductance value.

■ Q-Frequency Characteristics (Typ.)

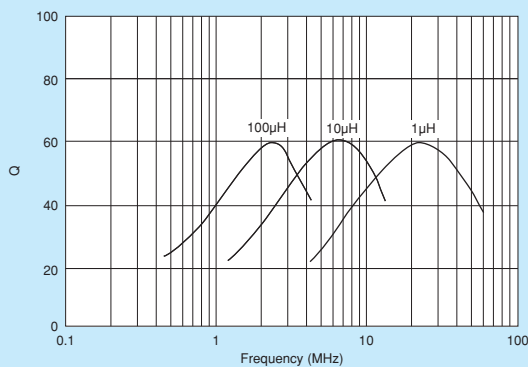

■ Inductance-Current Characteristics (Typ.)

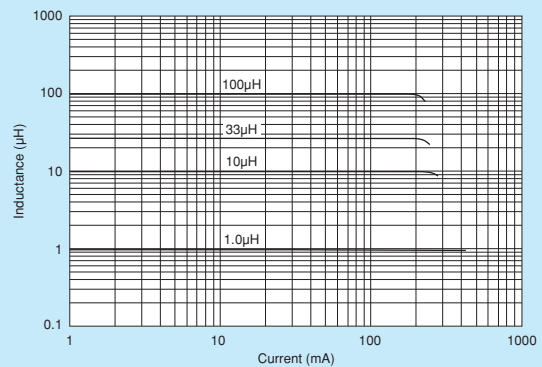

△Note • Please read rating and △CAUTION (for storage, operating, rating, soldering, mounting and handling) in this catalog to prevent smoking and/or burning, etc.
• This catalog has only typical specifications. Therefore, please approve our product specifications or transact the approval sheet for product specifications before ordering.

LQH32MN_23 Series 1210/3225 (inch/mm)

Size Code 1210 (3225) in inch (in mm)

Appearance/Dimensions

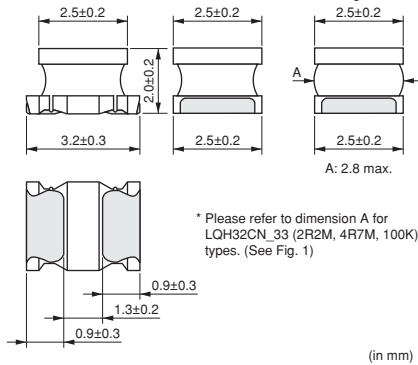

Packaging

Code	Packaging	Minimum Quantity
L	ø180mm Embossed Taping	2000
K	ø330mm Embossed Taping	7500



Refer to pages 137 to 140 for mounting information.

Rated Value (□: packaging code)

Part Number	Inductance	Inductance Test Frequency	Rated Current	Max. of DC Resistance	Q (min.)	Q Test Frequency	Self-Resonance Frequency (min.)	
LQH32MN1R0M23□	1.0μH ±20%	1MHz	445mA	0.5Ω	20	1MHz	100MHz	Kit
LQH32MN1R2M23□	1.2μH ±20%	1MHz	425mA	0.6Ω	20	1MHz	100MHz	Kit
LQH32MN1R5K23□	1.5μH ±10%	1MHz	400mA	0.6Ω	20	1MHz	75MHz	Kit
LQH32MN1R8K23□	1.8μH ±10%	1MHz	390mA	0.7Ω	20	1MHz	60MHz	Kit
LQH32MN2R2K23□	2.2μH ±10%	1MHz	370mA	0.8Ω	20	1MHz	50MHz	Kit
LQH32MN2R7K23□	2.7μH ±10%	1MHz	320mA	0.9Ω	20	1MHz	43MHz	Kit
LQH32MN3R3K23□	3.3μH ±10%	1MHz	300mA	1.0Ω	20	1MHz	38MHz	Kit
LQH32MN3R9K23□	3.9μH ±10%	1MHz	290mA	1.1Ω	20	1MHz	35MHz	Kit
LQH32MN4R7K23□	4.7μH ±10%	1MHz	270mA	1.2Ω	20	1MHz	31MHz	Kit
LQH32MN5R6K23□	5.6μH ±10%	1MHz	250mA	1.3Ω	20	1MHz	28MHz	Kit
LQH32MN6R8K23□	6.8μH ±10%	1MHz	240mA	1.5Ω	20	1MHz	25MHz	Kit
LQH32MN8R2K23□	8.2μH ±10%	1MHz	225mA	1.6Ω	20	1MHz	23MHz	Kit
LQH32MN100J23□	10μH ±5%	1MHz	190mA	1.8Ω	35	1MHz	20MHz	
LQH32MN100K23□	10μH ±10%	1MHz	190mA	1.8Ω	35	1MHz	20MHz	Kit
LQH32MN120J23□	12μH ±5%	1MHz	180mA	2.0Ω	35	1MHz	18MHz	
LQH32MN120K23□	12μH ±10%	1MHz	180mA	2.0Ω	35	1MHz	18MHz	Kit
LQH32MN150J23□	15μH ±5%	1MHz	170mA	2.2Ω	35	1MHz	16MHz	
LQH32MN150K23□	15μH ±10%	1MHz	170mA	2.2Ω	35	1MHz	16MHz	Kit
LQH32MN180J23□	18μH ±5%	1MHz	165mA	2.5Ω	35	1MHz	15MHz	
LQH32MN180K23□	18μH ±10%	1MHz	165mA	2.5Ω	35	1MHz	15MHz	Kit
LQH32MN220J23□	22μH ±5%	1MHz	150mA	2.8Ω	35	1MHz	14MHz	
LQH32MN220K23□	22μH ±10%	1MHz	150mA	2.8Ω	35	1MHz	14MHz	Kit
LQH32MN270J23□	27μH ±5%	1MHz	125mA	3.1Ω	35	1MHz	13MHz	
LQH32MN270K23□	27μH ±10%	1MHz	125mA	3.1Ω	35	1MHz	13MHz	Kit
LQH32MN330J23□	33μH ±5%	1MHz	115mA	3.5Ω	40	1MHz	12MHz	
LQH32MN330K23□	33μH ±10%	1MHz	115mA	3.5Ω	40	1MHz	12MHz	Kit
LQH32MN390J23□	39μH ±5%	1MHz	110mA	3.9Ω	40	1MHz	11MHz	
LQH32MN390K23□	39μH ±10%	1MHz	110mA	3.9Ω	40	1MHz	11MHz	Kit
LQH32MN470J23□	47μH ±5%	1MHz	100mA	4.3Ω	40	1MHz	11MHz	
LQH32MN470K23□	47μH ±10%	1MHz	100mA	4.3Ω	40	1MHz	11MHz	Kit
LQH32MN560J23□	56μH ±5%	1MHz	85mA	4.9Ω	40	1MHz	10MHz	
LQH32MN560K23□	56μH ±10%	1MHz	85mA	4.9Ω	40	1MHz	10MHz	Kit

Class of Magnetic Shield: No magnetic shield

Operating Temperature Range (Self-temperature rise is not included): -40°C~+85°C

Continued on the following page.

△Note • Please read rating and △CAUTION (for storage, operating, rating, soldering, mounting and handling) in this catalog to prevent smoking and/or burning, etc.
• This catalog has only typical specifications. Therefore, please approve our product specifications or transact the approval sheet for product specifications before ordering.

Part Number	Inductance	Inductance Test Frequency	Rated Current	Max. of DC Resistance	Q (min.)	Q Test Frequency	Self-Resonance Frequency (min.)	
LQH32MN680J23□	68μH ±5%	1MHz	80mA	5.5Ω	40	1MHz	9MHz	
LQH32MN680K23□	68μH ±10%	1MHz	80mA	5.5Ω	40	1MHz	9MHz	Kit
LQH32MN820J23□	82μH ±5%	1MHz	70mA	6.2Ω	40	1MHz	8.5MHz	
LQH32MN820K23□	82μH ±10%	1MHz	70mA	6.2Ω	40	1MHz	8.5MHz	Kit
LQH32MN101J23□	100μH ±5%	1MHz	80mA	7.0Ω	40	796kHz	8MHz	
LQH32MN101K23□	100μH ±10%	1MHz	80mA	7.0Ω	40	796kHz	8MHz	Kit
LQH32MN121J23□	120μH ±5%	1MHz	75mA	8.0Ω	40	796kHz	7.5MHz	
LQH32MN121K23□	120μH ±10%	1MHz	75mA	8.0Ω	40	796kHz	7.5MHz	Kit
LQH32MN151J23□	150μH ±5%	1MHz	70mA	9.3Ω	40	796kHz	7MHz	
LQH32MN151K23□	150μH ±10%	1MHz	70mA	9.3Ω	40	796kHz	7MHz	Kit
LQH32MN181J23□	180μH ±5%	1MHz	65mA	10.2Ω	40	796kHz	6MHz	
LQH32MN181K23□	180μH ±10%	1MHz	65mA	10.2Ω	40	796kHz	6MHz	Kit
LQH32MN221J23□	220μH ±5%	1MHz	65mA	11.8Ω	40	796kHz	5.5MHz	
LQH32MN221K23□	220μH ±10%	1MHz	65mA	11.8Ω	40	796kHz	5.5MHz	Kit
LQH32MN271J23□	270μH ±5%	1MHz	65mA	12.5Ω	40	796kHz	5MHz	
LQH32MN271K23□	270μH ±10%	1MHz	65mA	12.5Ω	40	796kHz	5MHz	Kit
LQH32MN331J23□	330μH ±5%	1MHz	65mA	13.0Ω	40	796kHz	5MHz	
LQH32MN331K23□	330μH ±10%	1MHz	65mA	13.0Ω	40	796kHz	5MHz	Kit
LQH32MN391J23□	390μH ±5%	1MHz	50mA	22.0Ω	50	796kHz	5MHz	
LQH32MN391K23□	390μH ±10%	1MHz	50mA	22.0Ω	50	796kHz	5MHz	Kit
LQH32MN471J23□	470μH ±5%	1kHz	45mA	25.0Ω	50	796kHz	5MHz	
LQH32MN471K23□	470μH ±10%	1kHz	45mA	25.0Ω	50	796kHz	5MHz	Kit
LQH32MN561J23□	560μH ±5%	1kHz	40mA	28.0Ω	50	796kHz	5MHz	
LQH32MN561K23□	560μH ±10%	1kHz	40mA	28.0Ω	50	796kHz	5MHz	Kit

Class of Magnetic Shield: No magnetic shield

Operating Temperature Range (Self-temperature rise is not included): -40°C~+85°C

■ Q-Frequency Characteristics (Typ.)

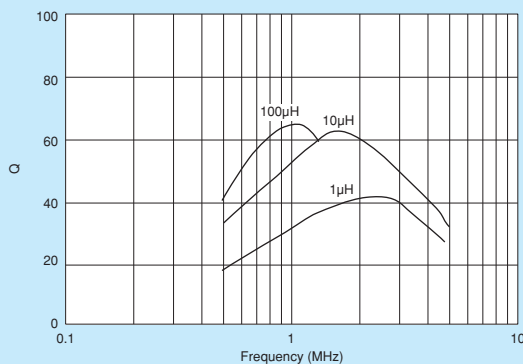

■ Inductance-Current Characteristics (Typ.)

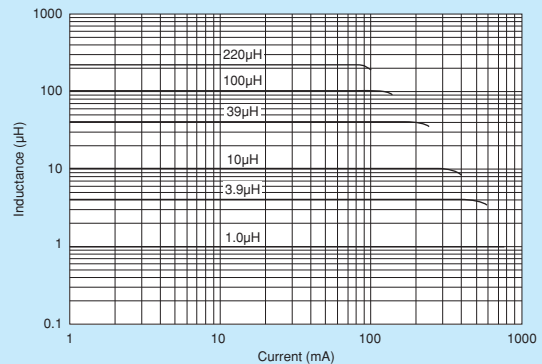

△Note • Please read rating and △CAUTION (for storage, operating, rating, soldering, mounting and handling) in this catalog to prevent smoking and/or burning, etc.
• This catalog has only typical specifications. Therefore, please approve our product specifications or transact the approval sheet for product specifications before ordering.

LQH43MN_03/LQH43NN_03 Series 1812/4532 (inch/mm)

Size Code 1812 (4532) in inch (in mm)

Appearance/Dimensions

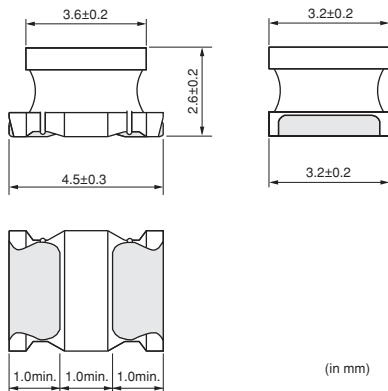

Packaging

Code	Packaging	Minimum Quantity
L	ø180mm Embossed Taping	500
K	ø330mm Embossed Taping	2500



Refer to pages 137 to 140 for mounting information.

Rated Value (□: packaging code)

Part Number	Inductance	Inductance Test Frequency	Rated Current	Max. of DC Resistance	Q (min.)	Q Test Frequency	Self-Resonance Frequency (min.)	
LQH43MN1R0M03□	1.0μH ±20%	1MHz	500mA	0.20Ω	20	1MHz	120MHz	Kit
LQH43MN1R2M03□	1.2μH ±20%	1MHz	500mA	0.20Ω	20	1MHz	100MHz	Kit
LQH43MN1R5M03□	1.5μH ±20%	1MHz	500mA	0.30Ω	20	1MHz	85MHz	Kit
LQH43MN1R8M03□	1.8μH ±20%	1MHz	500mA	0.30Ω	20	1MHz	75MHz	Kit
LQH43MN2R2M03□	2.2μH ±20%	1MHz	500mA	0.30Ω	20	1MHz	62MHz	Kit
LQH43MN2R7M03□	2.7μH ±20%	1MHz	500mA	0.32Ω	20	1MHz	53MHz	Kit
LQH43MN3R3M03□	3.3μH ±20%	1MHz	500mA	0.35Ω	20	1MHz	47MHz	Kit
LQH43MN3R9M03□	3.9μH ±20%	1MHz	500mA	0.38Ω	20	1MHz	41MHz	Kit
LQH43MN4R7K03□	4.7μH ±10%	1MHz	500mA	0.40Ω	30	1MHz	38MHz	Kit
LQH43MN5R6K03□	5.6μH ±10%	1MHz	500mA	0.47Ω	30	1MHz	33MHz	Kit
LQH43MN6R8K03□	6.8μH ±10%	1MHz	450mA	0.50Ω	30	1MHz	31MHz	Kit
LQH43MN8R2K03□	8.2μH ±10%	1MHz	450mA	0.56Ω	30	1MHz	27MHz	Kit
LQH43MN100J03□	10μH ±5%	1MHz	400mA	0.56Ω	35	1MHz	23MHz	
LQH43MN100K03□	10μH ±10%	1MHz	400mA	0.56Ω	35	1MHz	23MHz	Kit
LQH43MN120J03□	12μH ±5%	1MHz	380mA	0.62Ω	35	1MHz	21MHz	
LQH43MN120K03□	12μH ±10%	1MHz	380mA	0.62Ω	35	1MHz	21MHz	Kit
LQH43MN150J03□	15μH ±5%	1MHz	360mA	0.73Ω	35	1MHz	19MHz	
LQH43MN150K03□	15μH ±10%	1MHz	360mA	0.73Ω	35	1MHz	19MHz	Kit
LQH43MN180J03□	18μH ±5%	1MHz	340mA	0.82Ω	35	1MHz	17MHz	
LQH43MN180K03□	18μH ±10%	1MHz	340mA	0.82Ω	35	1MHz	17MHz	Kit
LQH43MN220J03□	22μH ±5%	1MHz	320mA	0.94Ω	35	1MHz	15MHz	
LQH43MN220K03□	22μH ±10%	1MHz	320mA	0.94Ω	35	1MHz	15MHz	Kit
LQH43MN270J03□	27μH ±5%	1MHz	300mA	1.1Ω	35	1MHz	14MHz	
LQH43MN270K03□	27μH ±10%	1MHz	300mA	1.1Ω	35	1MHz	14MHz	Kit
LQH43MN330J03□	33μH ±5%	1MHz	270mA	1.2Ω	35	1MHz	12MHz	
LQH43MN330K03□	33μH ±10%	1MHz	270mA	1.2Ω	35	1MHz	12MHz	Kit
LQH43MN390J03□	39μH ±5%	1MHz	240mA	1.4Ω	35	1MHz	11MHz	
LQH43MN390K03□	39μH ±10%	1MHz	240mA	1.4Ω	35	1MHz	11MHz	Kit
LQH43MN470J03□	47μH ±5%	1MHz	220mA	1.5Ω	35	1MHz	10MHz	
LQH43MN470K03□	47μH ±10%	1MHz	220mA	1.5Ω	35	1MHz	10MHz	Kit
LQH43MN560J03□	56μH ±5%	1MHz	200mA	1.7Ω	35	1MHz	9.3MHz	
LQH43MN560K03□	56μH ±10%	1MHz	200mA	1.7Ω	35	1MHz	9.3MHz	Kit

Class of Magnetic Shield: No magnetic shield

Operating Temperature Range (Self-temperature rise is not included): -40°C~+85°C

Continued on the following page.

△Note • Please read rating and △CAUTION (for storage, operating, rating, soldering, mounting and handling) in this catalog to prevent smoking and/or burning, etc.
• This catalog has only typical specifications. Therefore, please approve our product specifications or transact the approval sheet for product specifications before ordering.

Part Number	Inductance	Inductance Test Frequency	Rated Current	Max. of DC Resistance	Q (min.)	Q Test Frequency	Self-Resonance Frequency (min.)	
LQH43MN680J03□	68μH ±5%	1MHz	180mA	1.9Ω	35	1MHz	8.4MHz	
LQH43MN680K03□	68μH ±10%	1MHz	180mA	1.9Ω	35	1MHz	8.4MHz	Kit
LQH43MN820J03□	82μH ±5%	1MHz	170mA	2.2Ω	35	1MHz	7.5MHz	
LQH43MN820K03□	82μH ±10%	1MHz	170mA	2.2Ω	35	1MHz	7.5MHz	Kit
LQH43MN101J03□	100μH ±5%	1MHz	160mA	2.5Ω	40	796kHz	6.8MHz	
LQH43MN101K03□	100μH ±10%	1MHz	160mA	2.5Ω	40	796kHz	6.8MHz	Kit
LQH43MN121J03□	120μH ±5%	1MHz	150mA	3.0Ω	40	796kHz	6.2MHz	
LQH43MN121K03□	120μH ±10%	1MHz	150mA	3.0Ω	40	796kHz	6.2MHz	Kit
LQH43MN151J03□	150μH ±5%	1MHz	130mA	3.7Ω	40	796kHz	5.5MHz	
LQH43MN151K03□	150μH ±10%	1MHz	130mA	3.7Ω	40	796kHz	5.5MHz	Kit
LQH43MN181J03□	180μH ±5%	1MHz	120mA	4.5Ω	40	796kHz	5.0MHz	
LQH43MN181K03□	180μH ±10%	1MHz	120mA	4.5Ω	40	796kHz	5.0MHz	Kit
LQH43MN221J03□	220μH ±5%	1MHz	110mA	5.4Ω	40	796kHz	4.5MHz	
LQH43MN221K03□	220μH ±10%	1MHz	110mA	5.4Ω	40	796kHz	4.5MHz	Kit
LQH43MN271J03□	270μH ±5%	1MHz	100mA	6.8Ω	40	796kHz	4.0MHz	
LQH43MN271K03□	270μH ±10%	1MHz	100mA	6.8Ω	40	796kHz	4.0MHz	Kit
LQH43MN331J03□	330μH ±5%	1MHz	95mA	8.2Ω	40	796kHz	3.6MHz	
LQH43MN331K03□	330μH ±10%	1MHz	95mA	8.2Ω	40	796kHz	3.6MHz	Kit
LQH43MN391J03□	390μH ±5%	1MHz	90mA	9.7Ω	40	796kHz	3.3MHz	
LQH43MN391K03□	390μH ±10%	1MHz	90mA	9.7Ω	40	796kHz	3.3MHz	Kit
LQH43MN471J03□	470μH ±5%	1kHz	80mA	11.8Ω	40	796kHz	3.0MHz	
LQH43MN471K03□	470μH ±10%	1kHz	80mA	11.8Ω	40	796kHz	3.0MHz	Kit
LQH43MN561J03□	560μH ±5%	1kHz	70mA	14.5Ω	40	796kHz	2.7MHz	
LQH43MN561K03□	560μH ±10%	1kHz	70mA	14.5Ω	40	796kHz	2.7MHz	Kit
LQH43MN681J03□	680μH ±5%	1kHz	65mA	17.0Ω	40	796kHz	2.5MHz	
LQH43MN681K03□	680μH ±10%	1kHz	65mA	17.0Ω	40	796kHz	2.5MHz	Kit
LQH43MN821J03□	820μH ±5%	1kHz	60mA	20.5Ω	40	796kHz	2.2MHz	
LQH43MN821K03□	820μH ±10%	1kHz	60mA	20.5Ω	40	796kHz	2.2MHz	Kit
LQH43MN102J03□	1000μH ±5%	1kHz	50mA	25.0Ω	40	252kHz	2.0MHz	
LQH43MN102K03□	1000μH ±10%	1kHz	50mA	25.0Ω	40	252kHz	2.0MHz	Kit
LQH43MN122J03□	1200μH ±5%	1kHz	45mA	30.0Ω	40	252kHz	1.8MHz	
LQH43MN122K03□	1200μH ±10%	1kHz	45mA	30.0Ω	40	252kHz	1.8MHz	Kit
LQH43MN152J03□	1500μH ±5%	1kHz	40mA	37.0Ω	40	252kHz	1.6MHz	
LQH43MN152K03□	1500μH ±10%	1kHz	40mA	37.0Ω	40	252kHz	1.6MHz	Kit
LQH43NN182J03□	1800μH ±5%	1kHz	35mA	45.0Ω	40	252kHz	1.5MHz	
LQH43NN182K03□	1800μH ±10%	1kHz	35mA	45.0Ω	40	252kHz	1.5MHz	Kit
LQH43NN222J03□	2200μH ±5%	1kHz	30mA	50.0Ω	40	252kHz	1.3MHz	
LQH43NN222K03□	2200μH ±10%	1kHz	30mA	50.0Ω	40	252kHz	1.3MHz	Kit

Class of Magnetic Shield: No magnetic shield

Operating Temperature Range (Self-temperature rise is not included): -40°C~+85°C

Continued on the following page. 

△Note • Please read rating and △CAUTION (for storage, operating, rating, soldering, mounting and handling) in this catalog to prevent smoking and/or burning, etc.
 • This catalog has only typical specifications. Therefore, please approve our product specifications or transact the approval sheet for product specifications before ordering.

■ Q-Frequency Characteristics (Typ.)

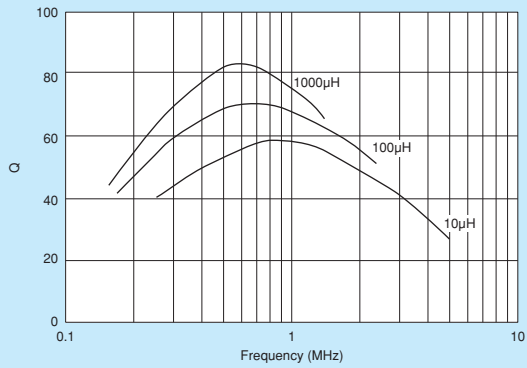

■ Inductance-Current Characteristics (Typ.)

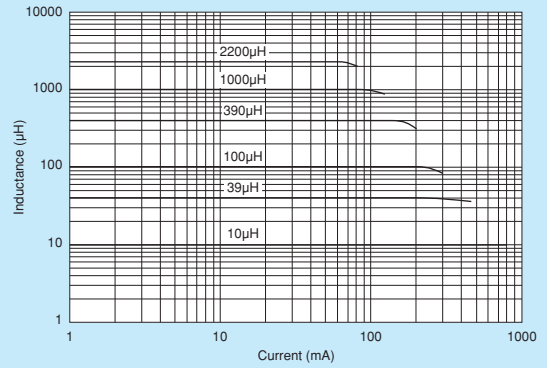

⚠Note • Please read rating and ⚠CAUTION (for storage, operating, rating, soldering, mounting and handling) in this catalog to prevent smoking and/or burning, etc.
• This catalog has only typical specifications. Therefore, please approve our product specifications or transact the approval sheet for product specifications before ordering.

LQH44NN_03 Series 1515/4040 (inch/mm)

Size Code 1515 (4040) in inch (in mm), General

Appearance/Dimensions

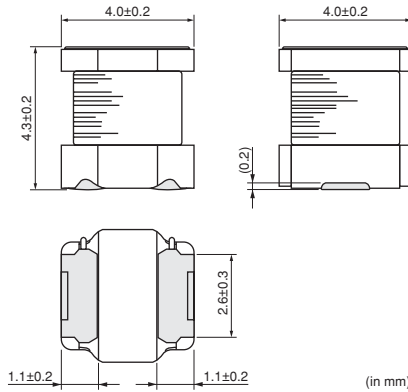

Packaging

Code	Packaging	Minimum Quantity
L	ø180mm Embossed Taping	250
K	ø330mm Embossed Taping	1500



Refer to pages 137 to 140 for mounting information.

Rated Value (□: packaging code)

Part Number	Inductance	Inductance Test Frequency	Rated Current ^{*1}	DC Resistance	Self-Resonance Frequency (min.)	
LQH44NNR51M03□	0.51μH ±20%	1kHz	4.5A	0.0075Ω ±30%	160MHz	New
LQH44NNR74M03□	0.74μH ±20%	1kHz	3.5A	0.011Ω ±30%	150MHz	New
LQH44NN1R0M03□	1.0μH ±20%	1kHz	3.3A	0.012Ω ±30%	90MHz	New
LQH44NN1R5M03□	1.5μH ±20%	1kHz	3.2A	0.016Ω ±30%	70MHz	New
LQH44NN2R2M03□	2.2μH ±20%	1kHz	2.5A	0.019Ω ±20%	55MHz	New
LQH44NN3R3M03□	3.3μH ±20%	1kHz	2.25A	0.024Ω ±30%	34.8MHz	New
LQH44NN4R7M03□	4.7μH ±20%	1kHz	1.95A	0.040Ω ±30%	23.4MHz	New
LQH44NN5R0K03□	5.0μH ±10%	1kHz	1.95A	0.040Ω ±30%	23.4MHz	New
LQH44NN6R8K03□	6.8μH ±10%	1kHz	1.6A	0.051Ω ±30%	19.8MHz	New
LQH44NN100K03□	10μH ±10%	1kHz	1.3A	0.067Ω ±30%	23.5MHz	New
LQH44NN150K03□	15μH ±10%	1kHz	1.1A	0.100Ω ±30%	11.5MHz	New
LQH44NN220K03□	22μH ±10%	1kHz	0.95A	0.170Ω ±30%	14MHz	New
LQH44NN330K03□	33μH ±10%	1kHz	0.76A	0.210Ω ±30%	12MHz	New
LQH44NN470K03□	47μH ±10%	1kHz	0.64A	0.330Ω ±30%	10MHz	New
LQH44NN680K03□	68μH ±10%	1kHz	0.53A	0.410Ω ±30%	8.0MHz	New
LQH44NN101K03□	100μH ±10%	1kHz	0.3A	0.540Ω ±30%	6.3MHz	New
LQH44NN151K03□	150μH ±10%	1kHz	0.26A	0.920Ω ±30%	5.2MHz	New
LQH44NN221K03□	220μH ±10%	1kHz	0.21A	1.20Ω ±30%	3.9MHz	New
LQH44NN331K03□	330μH ±10%	1kHz	0.18A	1.76Ω ±30%	3.0MHz	New
LQH44NN471K03□	470μH ±10%	1kHz	0.145A	2.23Ω ±30%	2.7MHz	New

Class of Magnetic Shield: No magnetic shield

Operating Temperature Range (Self-temperature rise is included): -40°C~+125°C

Operating Temperature Range (Self-temperature rise is not included): -40°C~+85°C

For reflow soldering only.

*1 When applied rated current to the products, self-temperature rise shall be limited to 40°C max. and inductance will be within ±20% of initial inductance value.

Continued on the following page.

[△]Note • Please read rating and [△]CAUTION (for storage, operating, rating, soldering, mounting and handling) in this catalog to prevent smoking and/or burning, etc.
• This catalog has only typical specifications. Therefore, please approve our product specifications or transact the approval sheet for product specifications before ordering.

■ Inductance-Current Characteristics (Typ.)

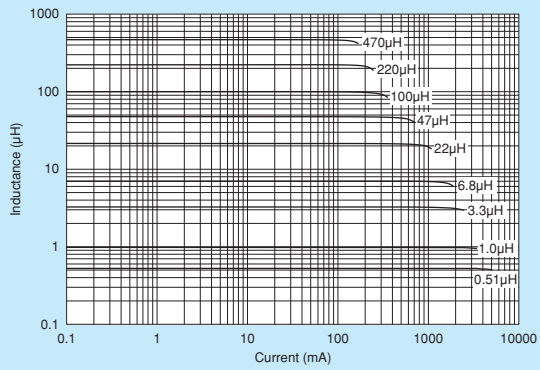

Inductors for Power Lines

Wire Wound Type (Ferrite Core)
Inductors for General Use

RF Inductors

⚠Note • Please read rating and ⚠CAUTION (for storage, operating, rating, soldering, mounting and handling) in this catalog to prevent smoking and/or burning, etc.
• This catalog has only typical specifications. Therefore, please approve our product specifications or transact the approval sheet for product specifications before ordering.

⚠ Caution

● Rating

1. About the Rated Current

Do not use products beyond the rated current as this may create excessive heat and deteriorate the insulation resistance.

2. About Excessive Surge Current

Surge current (pulse current or rush current) greater than the specified rated current applied to the product may cause a critical failure, such as an open circuit, burnout caused by excessive temperature rise. Please contact us in advance in case of applying the surge current.

Notice

● Storage and Operating Condition

<Operating Environment>

Do not use products in chemical atmosphere such as chlorine gas, acid or sulfide gas.

<Storage Requirements>

1. Storage Period

LQB series and LQM series should be used within 6 months; the other products should be used within 12 months.

Check solderability if this period is exceeded.

2. Storage Conditions

(1) Store products in a warehouse in compliance with the following conditions:

Temperature: -10 to +40 degrees C.

Humidity: 15 to 85% (relative humidity)

Do not subject products to rapid changes in temperature and humidity.

Do not store them in chemical atmosphere such as one containing sulfuric acid gas or alkaline gas.

This will prevent electrode oxidation, which causes poor solderability and possible corrosion of inductors.

(2) Do not store products in bulk packaging to prevent collision among inductors, which causes core chipping and wire breakage.

(3) Store products on pallets to protect from humidity, dust, etc.

(4) Avoid heat shock, vibration, direct sunlight, etc.

● Handling

This item is designed to have sufficient strength, but handle with care to avoid chipping or breaking its ceramic structure.

LQH_M/N series

- To prevent breaking the wire, avoid touching with sharp material, such as tweezers or the bristles of a cleaning brush, to the wire wound portion of this product.
- To prevent breaking the core, avoid applying excessive mechanical shock to products mounted on the board.

LQB series and LQM series

- There is the possibility that magnetism may change the inductance value. Do not use a magnet or

tweezers with magnetism when handling chip inductors. (The tip of the tweezers should be molded with resin or pottery.)

- When excessive current over the rated current is applied, it may cause the inductance value to change due to magnetism.

<Handling>

1. Avoid applying excessive stress to products to prevent damage.

2. Do not touch wire wound with sharp objects such as tweezers to prevent wire breakage.

3. Do not apply excessive force to products mounted on boards to prevent core breakage.

<Transportation>

Do not apply excessive vibration or mechanical shock to products.

<Resin Coating>

When coating products with resin, the relatively high resin curing stress may change inductance values.

For exterior coating, select resin carefully so that electrical and mechanical performance of the product is not affected. Prior to use, please evaluate reliability with the product mounted in your application set.

(LQH series)

An open circuit issue may occur by mechanical stress caused by the resin, amount/cured shape of resin, or operating conditions, etc. Some resins containing impurities or chloride may possibly generate chlorine by hydrolysis under some operating conditions, causing corrosion of the inductor wire and leading to an open circuit.

<Handling of a Substrate>

After mounting products on a substrate, do not apply any stress to the product caused by bending or twisting the substrate when cropping the substrate, inserting and removing a connector from the substrate, or tightening a screw to the substrate. Excessive mechanical stress may cause cracking in the Product.

Bending

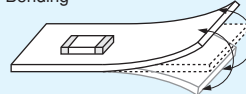

Twisting

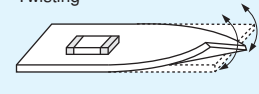

1. Standard Land Pattern Dimensions

A high Q value is achieved when the PCB electrode land pattern is designed so that it does not project beyond the chip Inductors (chip coils) electrode.

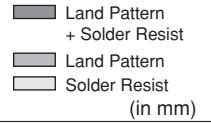

Series	Standard Land Dimensions																																				
LQB15N LQB18N LQM18N LQM21N LQH31M LQH44N		<table border="1"> <thead> <tr> <th>Part Number</th> <th></th> <th>a</th> <th>b</th> <th>c</th> </tr> </thead> <tbody> <tr> <td>LQB15NN</td> <td>Reflow</td> <td>0.4</td> <td>1.2-1.4</td> <td>0.5</td> </tr> <tr> <td>LQB18N</td> <td>Flow</td> <td rowspan="2">0.7</td> <td>2.2-2.6</td> <td rowspan="2">0.7</td> </tr> <tr> <td>LQM18N</td> <td>Reflow</td> <td>1.8-2.0</td> </tr> <tr> <td>LQM21N</td> <td></td> <td>1.2</td> <td>3.0-4.0</td> <td>1.0</td> </tr> <tr> <td>LQH31M</td> <td></td> <td>1.0</td> <td>4.5</td> <td>1.5</td> </tr> <tr> <td>LQH44N</td> <td></td> <td>1.3</td> <td>4.4</td> <td>3.0</td> </tr> </tbody> </table>			Part Number		a	b	c	LQB15NN	Reflow	0.4	1.2-1.4	0.5	LQB18N	Flow	0.7	2.2-2.6	0.7	LQM18N	Reflow	1.8-2.0	LQM21N		1.2	3.0-4.0	1.0	LQH31M		1.0	4.5	1.5	LQH44N		1.3	4.4	3.0
		Part Number		a	b	c																															
		LQB15NN	Reflow	0.4	1.2-1.4	0.5																															
		LQB18N	Flow	0.7	2.2-2.6	0.7																															
		LQM18N	Reflow		1.8-2.0																																
		LQM21N		1.2	3.0-4.0	1.0																															
LQH31M		1.0	4.5	1.5																																	
LQH44N		1.3	4.4	3.0																																	
LQH32M																																					
LQH43M LQH43N																																					

Attention should be paid to potential magnetic coupling effects when using the Inductors (coils) as a resonator.

2. Standard Soldering Conditions

(1) Soldering method

Chip Inductors (Chip coils) can be flow or reflow soldered.

Please contact Murata regarding other soldering methods.

Solder: Use Sn-3.0Ag-0.5Cu solder.

Flux: Use rosin-based flux, but not strongly acidic flux (with chlorine content exceeding 0.2wt%).

Do not use water-soluble flux.

For additional mounting methods, please contact Murata.

Continued on the following page.

Note • Please read rating and **CAUTION** (for storage, operating, rating, soldering, mounting and handling) in this catalog to prevent smoking and/or burning, etc.
 • This catalog has only typical specifications. Therefore, please approve our product specifications or transact the approval sheet for product specifications before ordering.

(2) Soldering profile

● Flow Soldering profile
(Sn-3.0Ag-0.5Cu solder)

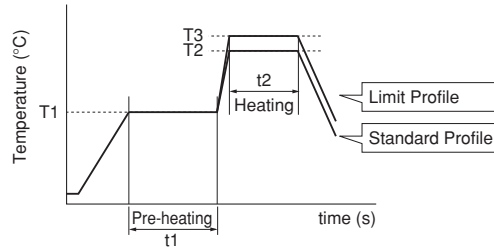

Series	Pre-heating		Standard Profile			Limit Profile		
	Temp. (T1)	Time. (t1)	Heating		Cycle of flow	Heating		Cycle of flow
			Temp. (T2)	Time. (t2)		Temp. (T3)	Time. (t2)	
LQB18N LQM18N LQM21N LQH31M	150°C	60s min.	250°C	4 to 6s	2 times max.	265±3°C	5s max.	2 times max.
LQH32M LQH43M(N)	150°C	60s min.	250°C	4 to 6s	2 times max.	265±3°C	5s max.	1 times

● Reflow Soldering profile
(Sn-3.0Ag-0.5Cu solder)

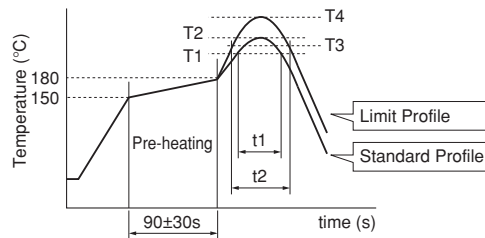

Series	Standard Profile				Limit Profile			
	Heating		Peak temperature (T2)	Cycle of reflow	Heating		Peak temperature (T4)	Cycle of reflow
	Temp. (T1)	Time. (t1)			Temp. (T3)	Time. (t2)		
LQB15N LQB18N LQM18N LQM21N LQH31M LQH44N	220°C	30 to 60s	245±3°C	2 times max.	230°C	60s max.	260°C/10s	2 times max.
LQH32M LQH43M(N)	220°C	30 to 60s	245±3°C	2 times max.	230°C	60s max.	260°C/10s	1 time

(3) Reworking with Soldering Iron

Preheating at 150°C for 1 minute is required. Do not directly touch the ceramic element with the tip of the soldering iron. The reworking soldering conditions are as follows:

Soldering iron power output: 80W max.
Temperature of soldering iron tip: 350°C
Diameter of soldering iron end: 3.0mm max.
Soldering time: within 3 s

Continued on the following page.

△Note • Please read rating and △CAUTION (for storage, operating, rating, soldering, mounting and handling) in this catalog to prevent smoking and/or burning, etc.
• This catalog has only typical specifications. Therefore, please approve our product specifications or transact the approval sheet for product specifications before ordering.

3. Mounting Instructions

(1) Land Pattern Dimensions

Large lands reduce Q of the mounted chip. Also, large protruding land areas (bordered by lines having dimensions 'c' and 'd' shown) cause floating and electrode leaching.

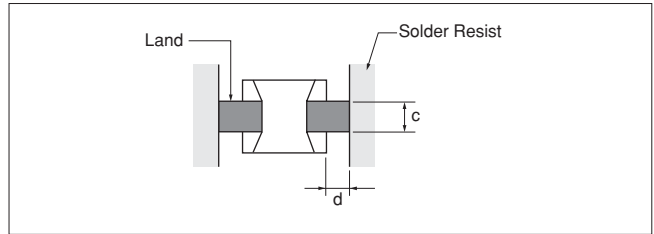

(2) Land Pattern Designing (LQH series)

Please follow the recommended patterns. Otherwise, their performance, which includes electrical performance or solderability, may be affected, or result in "position shift" in the soldering process.

(3) Magnetic Coupling

Since some chip inductors (chip coils) are constructed like an open magnetic circuit, narrow spacing between inductors (coils) may cause magnetic coupling. LQB/LQM series have a magnetically shielded structure. The structure makes their coupling coefficient smaller than that of conventional chip inductors (chip coils).

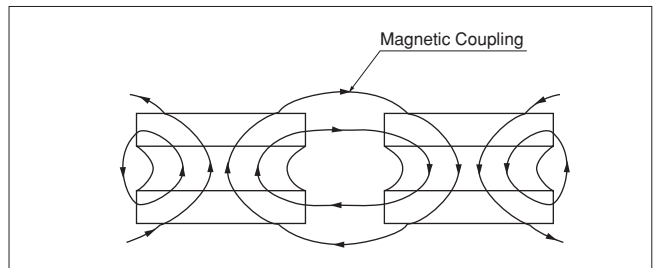

(4) PCB Warping

PCB should be designed so that products are not subjected to the mechanical stress caused by warping the board.

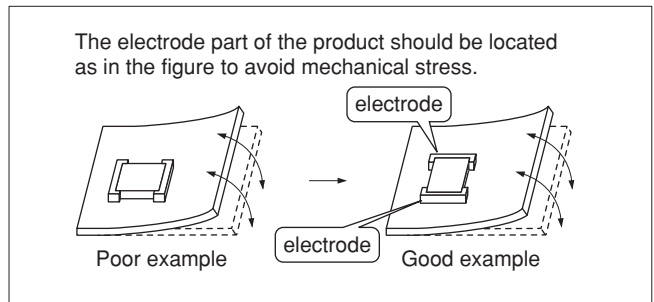
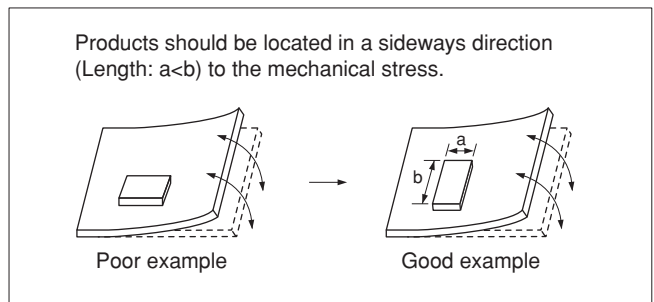

(5) Amount of Solder Paste

Excessive solder causes electrode corrosion, while insufficient solder causes low electrode bonding strength. Adjust the amount of solder paste as shown on the right so that solder is applied.

- Guideline of solder paste thickness
 - LQB/LQM: 100 to 150μm
 - LQHs except for ones written above: 200 to 300μm

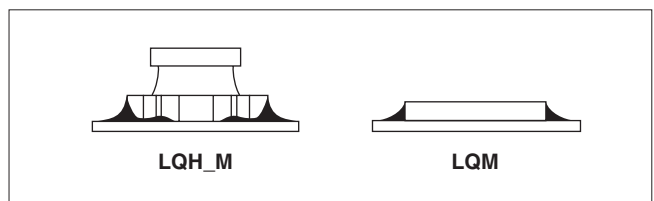

Continued on the following page.

⚠Note • Please read rating and ⚠CAUTION (for storage, operating, rating, soldering, mounting and handling) in this catalog to prevent smoking and/or burning, etc.
 • This catalog has only typical specifications. Therefore, please approve our product specifications or transact the approval sheet for product specifications before ordering.

(6) Amount of Adhesive

If too much adhesive is applied, then it may overflow into the land or termination areas and yield poor solderability. In contrast, if insufficient adhesive is applied, or if the adhesive is not sufficiently hardened, then the chip may become detached during flow soldering. Apply the adhesive in accordance with the conditions shown in the chart.



Part Number	Typical Application Amount (in:mg)
	IR-100
LQB18N/LQM18N	0.06-0.07
LQM21N	0.20-0.25
LQH31M	0.20-0.25
LQH32M	0.27-0.35
LQH43M(N)	0.60-0.80

4. Cleaning

The following conditions should be observed when cleaning chip inductors (chip coils):

- (1) Cleaning Temperature: 60°C max. (40°C max. for alcohol cleaning agents)
- (2) Ultrasonic
 - Output: 20W/l max.
 - Duration: 5 minutes max.
 - Frequency: 28 to 40kHz
 - Care should be taken not to cause resonance of the PCB and mounted products.
- (3) Cleaning agent
 - The following cleaning agents have been tested on individual components. Evaluation in complete assembly should be done prior to production.
 - (a) Alcohol cleaning agents
 - Isopropyl alcohol (IPA)
 - (b) Aqueous cleaning agents
 - Pine Alpha ST-100S

- (4) Ensure that flux residue is completely removed. Component should be thoroughly dried after aqueous agents have been removed with deionized water.

For additional cleaning methods, please contact Murata.

⚠Note • Please read rating and ⚠CAUTION (for storage, operating, rating, soldering, mounting and handling) in this catalog to prevent smoking and/or burning, etc.
• This catalog has only typical specifications. Therefore, please approve our product specifications or transact the approval sheet for product specifications before ordering.

■ Minimum Quantity and 8mm Width Taping Dimensions

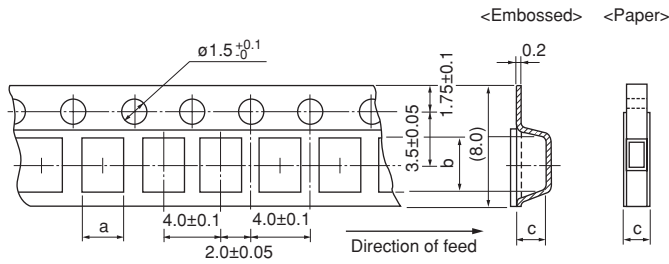

Dimension of the cavity of embossed tape is measured at the bottom side.

Paper Tape

Part Number	Dimensions		Total Thickness of Tape	Packaging Code (Minimum Qty. [pcs.])		
	a	b		Ø180mm reel	Ø330mm reel	Bulk
LQB15N	1.15	0.65	0.8 max.	D [10000]	J [50000]	B [1000]
LQB18N	1.05	1.85	1.1 max.	D [4000]	-	B [1000]
LQM21N (0.1-2.2µH)	1.45	2.25	1.1 max.	D [4000]	J [10000]	B [1000]
LQM18N	1.05	1.85	1.1 max.	D [4000]	J [10000]	B [1000]

Embossed Tape

Part Number	Dimensions		Depth of Cavity	Packaging Code (Minimum Qty. [pcs.])		
	a	b		Ø180mm reel	Ø330mm reel	Bulk
LQM21N (2.7-4.7µH)	1.45	2.25	1.3	L [3000]	K [10000]	B [1000]
LQH31M	1.9	3.6	2.0	L [2000]	K [7500]	-
LQH32M	2.9	3.6	2.1	L [2000]	K [7500]	-

(in mm)

■ Minimum Quantity and 12mm Width Embossed Taping Dimensions

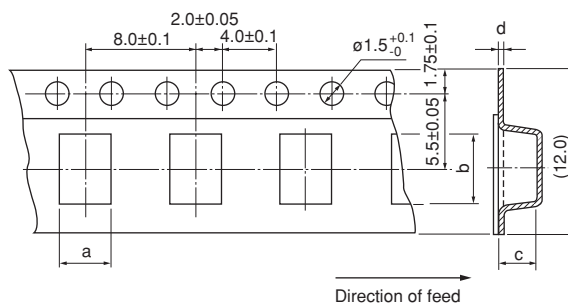

Dimension of the cavity of embossed tape is measured at the bottom side.

Embossed Tape

Part Number	Dimensions (*c: Depth of Cavity)				Packaging Code (Minimum Qty. [pcs.])		
	a	b	c	d	Ø180mm reel	Ø330mm reel	Bulk
LQH43M(N)	3.6	4.9	2.7	0.3	L [500]	K [2500]	-
LQH44N	4.3	4.3	4.7	0.4	L [250]	K [1500]	-

(in mm)

△Note • Please read rating and △CAUTION (for storage, operating, rating, soldering, mounting and handling) in this catalog to prevent smoking and/or burning, etc.
 • This catalog has only typical specifications. Therefore, please approve our product specifications or transact the approval sheet for product specifications before ordering.

■ Holder Type



● EKLMQM18B-KIT (for General Use Multilayer Type)

No.	Part Number	Quantity (pcs.)	Inductance		Q (min.)	DC Resistance (Ω) max.	Rated Current (mA)
			Nominal	Tolerance			
1	LQM18NN47NM00	10	47nH	±20%	10	0.30	50
2	LQM18NN68NM00	10	68nH	±20%	10	0.30	50
3	LQM18NN82NM00	10	82nH	±20%	10	0.30	50
4	LQM18NNR10K00	10	100nH	±10%	15	0.50	50
5	LQM18NNR12K00	10	120nH	±10%	15	0.50	50
6	LQM18NNR15K00	10	150nH	±10%	15	0.60	50
7	LQM18NNR18K00	10	180nH	±10%	15	0.60	50
8	LQM18NNR22K00	10	220nH	±10%	15	0.80	50
9	LQM18NNR27K00	10	270nH	±10%	15	0.80	50
10	LQM18NNR33K00	10	330nH	±10%	15	0.85	35
11	LQM18NNR39K00	10	390nH	±10%	15	1.00	35
12	LQM18NNR47K00	10	470nH	±10%	15	1.35	35
13	LQM18NNR56K00	10	560nH	±10%	15	1.55	35
14	LQM18NNR68K00	10	680nH	±10%	15	1.70	35
15	LQM18NNR82K00	10	820nH	±10%	15	2.10	35
16	LQM18NN1R0K00	10	1000nH	±10%	35	0.60	25
17	LQM18NN1R2K00	10	1200nH	±10%	35	0.80	25
18	LQM18NN1R5K00	10	1500nH	±10%	35	0.80	25
19	LQM18NN1R8K00	10	1800nH	±10%	35	0.95	25
20	LQM18NN2R2K00	10	2200nH	±10%	35	1.15	15

● EKLM21NB-KIT (for General Use Multilayer Type)

No.	Part Number	Quantity (pcs.)	Inductance		Q (min.)	DC Resistance (Ω) max.	Rated Current (mA)
			Nominal	Tolerance			
1	LQM21NNR10K10	10	0.1μH	±10%	20	0.26	250
2	LQM21NNR12K10	10	0.12μH	±10%	20	0.29	250
3	LQM21NNR15K10	10	0.15μH	±10%	20	0.32	250
4	LQM21NNR18K10	10	0.18μH	±10%	20	0.35	250
5	LQM21NNR22K10	10	0.22μH	±10%	20	0.38	250
6	LQM21NNR27K10	10	0.27μH	±10%	20	0.42	250
7	LQM21NNR33K10	10	0.33μH	±10%	20	0.48	250
8	LQM21NNR39K10	10	0.39μH	±10%	25	0.53	200
9	LQM21NNR47K10	10	0.47μH	±10%	25	0.57	200
10	LQM21NNR56K10	10	0.56μH	±10%	25	0.63	150
11	LQM21NNR68K10	10	0.68μH	±10%	25	0.72	150
12	LQM21NNR82K10	10	0.82μH	±10%	25	0.81	150
13	LQM21NN1R0K10	10	1.0μH	±10%	45	0.40	50
14	LQM21NN1R2K10	10	1.2μH	±10%	45	0.47	50
15	LQM21NN1R5K10	10	1.5μH	±10%	45	0.50	50
16	LQM21NN1R8K10	10	1.8μH	±10%	45	0.57	50
17	LQM21NN2R2K10	10	2.2μH	±10%	45	0.63	30
18	LQM21NN2R7K10	10	2.7μH	±10%	45	0.69	30
19	LQM21NN3R3K10	10	3.3μH	±10%	45	0.80	30
20	LQM21NN3R9K10	10	3.9μH	±10%	45	0.89	30
21	LQM21NN4R7K10	10	4.7μH	±10%	45	1.00	30

● EKLMH32MC-KIT (for General Use Wire Wound Type)

No.	Part Number	Quantity (pcs.)	Inductance		DC Resistance (Ω) max.	Rated Current (mA)
			Nominal	Tolerance		
1	LQH32MN1R0M23	10	1.0μH	±20%	0.50	445
2	LQH32MN1R2M23	10	1.2μH	±20%	0.60	425
3	LQH32MN1R5K23	10	1.5μH	±10%	0.60	400
4	LQH32MN1R8K23	10	1.8μH	±10%	0.70	390
5	LQH32MN2R2K23	10	2.2μH	±10%	0.80	370
6	LQH32MN2R7K23	10	2.7μH	±10%	0.90	320

Continued on the following page.

⚠Note • Please read rating and ⚠CAUTION (for storage, operating, rating, soldering, mounting and handling) in this catalog to prevent smoking and/or burning, etc.
• This catalog has only typical specifications. Therefore, please approve our product specifications or transact the approval sheet for product specifications before ordering.



Continued from the preceding page.

No.	Part Number	Quantity (pcs.)	Inductance		DC Resistance (Ω) max.	Rated Current (mA)
			Nominal	Tolerance		
7	LQH32MN3R3K23	10	3.3 μ H	$\pm 10\%$	1.00	300
8	LQH32MN3R9K23	10	3.9 μ H	$\pm 10\%$	1.10	290
9	LQH32MN4R7K23	10	4.7 μ H	$\pm 10\%$	1.20	270
10	LQH32MN5R6K23	10	5.6 μ H	$\pm 10\%$	1.30	250
11	LQH32MN6R8K23	10	6.8 μ H	$\pm 10\%$	1.50	240
12	LQH32MN8R2K23	10	8.2 μ H	$\pm 10\%$	1.60	225
13	LQH32MN100K23	10	10 μ H	$\pm 10\%$	1.8	190
14	LQH32MN120K23	10	12 μ H	$\pm 10\%$	2.0	180
15	LQH32MN150K23	10	15 μ H	$\pm 10\%$	2.2	170
16	LQH32MN180K23	10	18 μ H	$\pm 10\%$	2.5	165
17	LQH32MN220K23	10	22 μ H	$\pm 10\%$	2.8	150
18	LQH32MN270K23	10	27 μ H	$\pm 10\%$	3.1	125
19	LQH32MN330K23	10	33 μ H	$\pm 10\%$	3.5	115
20	LQH32MN390K23	10	39 μ H	$\pm 10\%$	3.9	110
21	LQH32MN470K23	10	47 μ H	$\pm 10\%$	4.3	100
22	LQH32MN560K23	10	56 μ H	$\pm 10\%$	4.9	85
23	LQH32MN680K23	10	68 μ H	$\pm 10\%$	5.5	80
24	LQH32MN820K23	10	82 μ H	$\pm 10\%$	6.2	70
25	LQH32MN101K23	10	100 μ H	$\pm 10\%$	7.0	80
26	LQH32MN121K23	10	120 μ H	$\pm 10\%$	8.0	75
27	LQH32MN151K23	10	150 μ H	$\pm 10\%$	9.3	70
28	LQH32MN181K23	10	180 μ H	$\pm 10\%$	10.2	65
29	LQH32MN221K23	10	220 μ H	$\pm 10\%$	11.8	65
30	LQH32MN271K23	10	270 μ H	$\pm 10\%$	12.5	65
31	LQH32MN331K23	10	330 μ H	$\pm 10\%$	13.0	65
32	LQH32MN391K23	10	390 μ H	$\pm 10\%$	22.0	50
33	LQH32MN471K23	10	470 μ H	$\pm 10\%$	25.0	45
34	LQH32MN561K23	10	560 μ H	$\pm 10\%$	28.0	40

●EKL43MB-KIT (for General Use Wire Wound Type)

No.	Part Number	Quantity (pcs.)	Inductance		DC Resistance (Ω) max.	Rated Current (mA)
			Nominal	Tolerance		
1	LQH43MN1R0M03	10	1.0 μ H	$\pm 20\%$	0.20	500
2	LQH43MN1R2M03	10	1.2 μ H	$\pm 20\%$	0.20	500
3	LQH43MN1R5M03	10	1.5 μ H	$\pm 20\%$	0.30	500
4	LQH43MN1R8M03	10	1.8 μ H	$\pm 20\%$	0.30	500
5	LQH43MN2R2M03	10	2.2 μ H	$\pm 20\%$	0.30	500
6	LQH43MN2R7M03	10	2.7 μ H	$\pm 20\%$	0.32	500
7	LQH43MN3R3M03	10	3.3 μ H	$\pm 20\%$	0.35	500
8	LQH43MN3R9M03	10	3.9 μ H	$\pm 20\%$	0.38	500
9	LQH43MN4R7K03	10	4.7 μ H	$\pm 10\%$	0.40	500
10	LQH43MN5R6K03	10	5.6 μ H	$\pm 10\%$	0.47	500
11	LQH43MN6R8K03	10	6.8 μ H	$\pm 10\%$	0.50	450
12	LQH43MN8R2K03	10	8.2 μ H	$\pm 10\%$	0.56	450
13	LQH43MN100K03	10	10 μ H	$\pm 10\%$	0.56	400
14	LQH43MN120K03	10	12 μ H	$\pm 10\%$	0.62	380
15	LQH43MN150K03	10	15 μ H	$\pm 10\%$	0.73	360
16	LQH43MN180K03	10	18 μ H	$\pm 10\%$	0.82	340
17	LQH43MN220K03	10	22 μ H	$\pm 10\%$	0.94	320
18	LQH43MN270K03	10	27 μ H	$\pm 10\%$	1.10	300
19	LQH43MN330K03	10	33 μ H	$\pm 10\%$	1.20	270
20	LQH43MN390K03	10	39 μ H	$\pm 10\%$	1.40	240
21	LQH43MN470K03	10	47 μ H	$\pm 10\%$	1.50	220
22	LQH43MN560K03	10	56 μ H	$\pm 10\%$	1.7	200
23	LQH43MN680K03	10	68 μ H	$\pm 10\%$	1.9	180
24	LQH43MN820K03	10	82 μ H	$\pm 10\%$	2.2	170
25	LQH43MN101K03	10	100 μ H	$\pm 10\%$	2.5	160
26	LQH43MN121K03	10	120 μ H	$\pm 10\%$	3.0	150
27	LQH43MN151K03	10	150 μ H	$\pm 10\%$	3.7	130
28	LQH43MN181K03	10	180 μ H	$\pm 10\%$	4.5	120
29	LQH43MN221K03	10	220 μ H	$\pm 10\%$	5.4	110
30	LQH43MN271K03	10	270 μ H	$\pm 10\%$	6.8	100
31	LQH43MN331K03	10	330 μ H	$\pm 10\%$	8.2	95
32	LQH43MN391K03	10	390 μ H	$\pm 10\%$	9.7	90
33	LQH43MN471K03	10	470 μ H	$\pm 10\%$	11.8	80

Continued on the following page. 

 Note • Please read rating and  CAUTION (for storage, operating, rating, soldering, mounting and handling) in this catalog to prevent smoking and/or burning, etc.
 • This catalog has only typical specifications. Therefore, please approve our product specifications or transact the approval sheet for product specifications before ordering.

 Continued from the preceding page.

No.	Part Number	Quantity (pcs.)	Inductance		DC Resistance (Ω) max.	Rated Current (mA)
			Nominal	Tolerance		
34	LQH43MN561K03	10	560 μ H	$\pm 10\%$	14.5	70
35	LQH43MN681K03	10	680 μ H	$\pm 10\%$	17.0	65
36	LQH43MN821K03	10	820 μ H	$\pm 10\%$	20.5	60
37	LQH43MN102K03	10	1000 μ H	$\pm 10\%$	25.0	50
38	LQH43MN122K03	10	1200 μ H	$\pm 10\%$	30.0	45
39	LQH43MN152K03	10	1500 μ H	$\pm 10\%$	37.0	40
40	LQH43NN182K03	10	1800 μ H	$\pm 10\%$	45.0	35
41	LQH43NN222K03	10	2200 μ H	$\pm 10\%$	50.0	30

\triangle Note • Please read rating and \triangle CAUTION (for storage, operating, rating, soldering, mounting and handling) in this catalog to prevent smoking and/or burning, etc.
• This catalog has only typical specifications. Therefore, please approve our product specifications or transact the approval sheet for product specifications before ordering.

● RF Inductors

Introduction	146
Part Numbering	147
Product Detail	148
⚠Caution/Notice	225
Soldering and Mounting	227
Packaging	231
Design Kits	232

Introduction of RF Inductors

Applications of RF Inductors

LNA

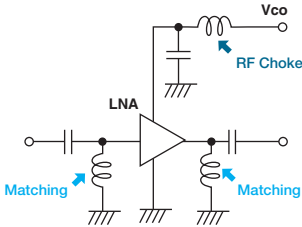

For Matching

High Q or tight inductance tolerance is required to improve signal quality. Especially, film type is suitable at receiver circuit because tight tolerance is required.

- Recommended
- | | |
|-------------------------------------|-----------------|
| Film Type | Wire Wound Type |
| LQP03T Series (for miniaturization) | LQW15A Series |
| LQP15M Series | LQW18A Series |
| Multilayer Type | LQW18A Series |
| LQG15H Series | |

For RF Choke

Low DC resistance is required because of large operation current. Wire wound type or multilayer type is suitable.

- Recommended
- | |
|-----------------|
| Wire Wound Type |
| LQW15A Series |
| LQW18A Series |
| Multilayer Type |
| LQG15H Series |

IF SAW Filter

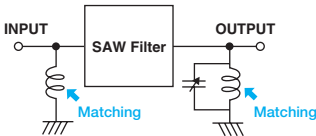

For Matching

High Q is required to reduce signal loss. Wire wound type and film type are suitable when tight tolerance is essential.

- Recommended
- | | |
|-----------------|-----------------|
| Wire Wound Type | Multilayer Type |
| LQW15A Series | LQG15H Series |
| LQW18A Series | |
| LQW2BH Series | |
| Film Type | |
| LQP03T Series | |
| LQP15M Series | |

VCO

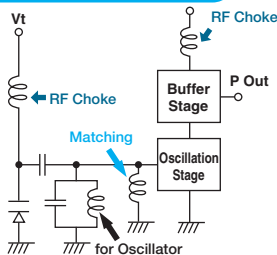

For Matching

For Oscillator

High Q or tight inductance tolerance is required to stabilize oscillation and signal quality. Wire wound type is suitable for high Q, film type is suitable for tight tolerance.

- Recommended
- | | |
|-------------------------------------|-----------------------------|
| Wire Wound Type | Film Type |
| LQW15A Series | LQP03T Series |
| LQW18A Series | (for miniaturization) |
| LQW18A_10 Series | LQP15M Series |
| (for output efficiency improvement) | (for frequency selectivity) |
| | Multilayer Type |
| | LQG15H Series |

For RF Choke

Low DC resistance is required because of large operation current. Wire wound type or multilayer type is suitable.

- Recommended
- | |
|------------------|
| Wire Wound Type |
| LQW15A Series |
| LQW18A Series |
| LQW18A_10 Series |
| Multilayer Type |
| LQG15H Series |

PA

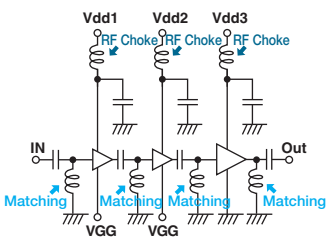

For Matching

Small shape is required. Film type is suitable because of its tight inductance tolerance and fine inductance step.

- Recommended
- | | |
|---|-------------------------------------|
| Film Type | Wire Wound Type |
| LQP02T Series | LQW15A Series |
| LQP03T Series (for miniaturization) | LQW18A Series |
| LQP15M Series (for frequency selectivity) | LQW18A_10 Series |
| Multilayer Type | LQW2BH Series |
| LQG15H Series | (for output efficiency improvement) |

For RF Choke

Low DC resistance is required because of large operation current. Especially, wire wound type is suitable for GSM because over 1A of current is working.

- Recommended
- | | |
|-------------------------------------|-----------------|
| Wire Wound Type | Multilayer Type |
| LQW15A Series | LQG15H Series |
| LQW18A Series | |
| LQW18A_10 Series | |
| LQW2BH Series | |
| (for output efficiency improvement) | |

ANTENNA

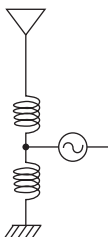

For Matching

LQW series is suitable for attaining high antenna sensitivity because of its high Q and tight tolerance spec.

- Recommended
- | |
|-----------------|
| Wire Wound Type |
| LQW15A Series |
| LQW18A Series |

△Note • Please read rating and CAUTION (for storage, operating, rating, soldering, mounting and handling) in this catalog to prevent smoking and/or burning, etc.
• This catalog has only typical specifications. Therefore, please approve our product specifications or transact the approval sheet for product specifications before ordering.

RF Inductors Part Numbering

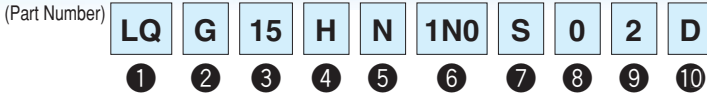

① Product ID

Product ID	
LQ	Chip Inductors (Chip Coils)

② Structure

Code	Structure
G	Multilayer Type (Air-core Inductors (Coils))
H	Wire Wound Type (Ferrite Core)
P	Film Type
W	Wire Wound Type (Air-core Inductors (Coils))
	Wire Wound Type (Ferrite Core)

③ Dimensions (L×W)

Code	Dimensions (L×W)	Size Code (in inch)
02	0.4×0.2mm	01005
03	0.6×0.3mm	0201
04	0.8×0.4mm	03015
15	1.0×0.5mm	0402
18	1.6×0.8mm	0603
21	2.0×1.25mm	0805
2B	2.0×1.5mm	0805
2U	2.5×2.0mm	1008
31	3.2×1.6mm	1206

④ Applications and Characteristics

Code	Series	Applications and Characteristics
H	LQG	Multilayer Air-core Inductors (Coils)
M	LQP	Film Type
T		Film Type (Low DC Resistance Type)
A	LQW	High Q Type (UHF-SHF)
H		High Q Type (VHF-UHF)
H	LQH	for High-frequency Resonant Circuit

⑤ Category

Code	Category
G/N	Standard Type
S	
Q	High Q Type
W	Specialty Dimensions

⑩ Packaging

Code	Packaging	Series
K	Embossed Taping (ø330mm Reel)	LQH/LQW□□H*2
L	Embossed Taping (ø180mm Reel)	LQH/LQW2BA/LQW2UA/LQW□□H
B	Bulk	LQW/LQG/LQP
J	Paper Taping (ø330mm Reel)	LQW18A/LQG/LQP*1
D	Paper Taping (ø180mm Reel)	LQW□□A*3 /LQG/LQP

*1 Except for LQP02T

*2 Except for LQW21H

*3 Except for LQW2BA/LQW2UA

⑥ Inductance

Expressed by three-digit alphanumeric. The unit is micro-henry (μH). The first and second figures are significant digits, and the third figure expresses the number of zeros that follow the two figures. If there is a decimal point, it is expressed by the capital letter "R." In this case, all figures are significant digits. If inductance is less than $0.1\mu\text{H}$, the inductance code is expressed by a combination of two figures and the capital letter "N," and the unit of inductance is nano-henry (nH). The capital letter "N" indicates the unit of "nH," and also expresses a decimal point. In this case, all figures are significant digits.

⑦ Inductance Tolerance

Code	Inductance Tolerance
B	$\pm 0.1\text{nH}$
C	$\pm 0.2\text{nH}$
D	$\pm 0.5\text{nH}$
G	$\pm 2\%$
H	$\pm 3\%$
J	$\pm 5\%$
K	$\pm 10\%$
S	$\pm 0.3\text{nH}$
W	$\pm 0.05\text{nH}$

⑧ Features

Code	Features	Series
0	Standard Type	LQG/LQP/LQW/LQH*1
1	High-Q/Low DC Resistance	LQW15A/18A/2BH
8	Low DC Resistance, Large Rated Current	LQW15A/LQW18A

*1 Except for LQH32 Series

⑨ Electrode

•Lead (Pb) Free

Code	Electrode	Series
0	Sn	LQG18H/LQW□□A/LQW□□C
2		LQG15H/LQP02T/LQP03T/LQP15T/LQP□□M
3	LF Solder	LQW□□H/LQH

LQG15HN_02 Series 0402/1005 (inch/mm)

Size Code 0402 (1005) in inch (in mm), Multilayer Type

Appearance/Dimensions

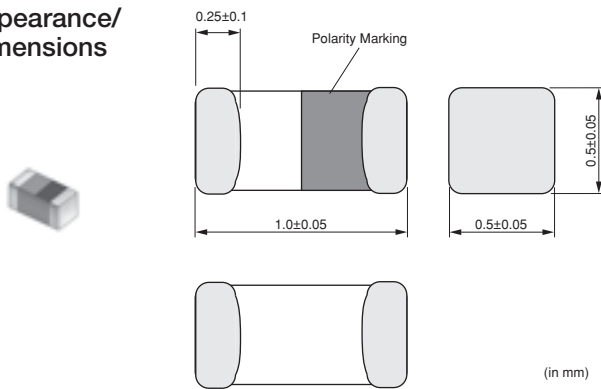

Packaging

Code	Packaging	Minimum Quantity
D	ø180mm Paper Taping	10000
J	ø330mm Paper Taping	50000
B	Packing in Bulk	1000



Refer to pages 227 to 230 for mounting information.

Rated Value (□: packaging code)

Part Number	Inductance	Inductance Test Frequency	Rated Current	Max. of DC Resistance	Q (min.)	Q Test Frequency	Self-Resonance Frequency (min.)
LQG15HN1N0S02□	1.0nH ±0.3nH	100MHz	300mA	0.10 Ω	8	100MHz	6000MHz
LQG15HN1N1S02□	1.1nH ±0.3nH	100MHz	300mA	0.10 Ω	8	100MHz	6000MHz
LQG15HN1N2S02□	1.2nH ±0.3nH	100MHz	300mA	0.10 Ω	8	100MHz	6000MHz
LQG15HN1N3S02□	1.3nH ±0.3nH	100MHz	300mA	0.10 Ω	8	100MHz	6000MHz
LQG15HN1N5S02□	1.5nH ±0.3nH	100MHz	300mA	0.10 Ω	8	100MHz	6000MHz
LQG15HN1N6S02□	1.6nH ±0.3nH	100MHz	300mA	0.10 Ω	8	100MHz	6000MHz
LQG15HN1N8S02□	1.8nH ±0.3nH	100MHz	300mA	0.10 Ω	8	100MHz	6000MHz
LQG15HN2N0S02□	2.0nH ±0.3nH	100MHz	300mA	0.12 Ω	8	100MHz	6000MHz
LQG15HN2N2S02□	2.2nH ±0.3nH	100MHz	300mA	0.15 Ω	8	100MHz	6000MHz
LQG15HN2N4S02□	2.4nH ±0.3nH	100MHz	300mA	0.16 Ω	8	100MHz	6000MHz
LQG15HN2N7S02□	2.7nH ±0.3nH	100MHz	300mA	0.17 Ω	8	100MHz	6000MHz
LQG15HN3N0S02□	3.0nH ±0.3nH	100MHz	300mA	0.18 Ω	8	100MHz	6000MHz
LQG15HN3N3S02□	3.3nH ±0.3nH	100MHz	300mA	0.19 Ω	8	100MHz	6000MHz
LQG15HN3N6S02□	3.6nH ±0.3nH	100MHz	300mA	0.19 Ω	8	100MHz	6000MHz
LQG15HN3N9S02□	3.9nH ±0.3nH	100MHz	300mA	0.19 Ω	8	100MHz	6000MHz
LQG15HN4N3S02□	4.3nH ±0.3nH	100MHz	300mA	0.21 Ω	8	100MHz	6000MHz
LQG15HN4N7S02□	4.7nH ±0.3nH	100MHz	300mA	0.23 Ω	8	100MHz	6000MHz
LQG15HN5N1S02□	5.1nH ±0.3nH	100MHz	300mA	0.24 Ω	8	100MHz	6000MHz
LQG15HN5N6S02□	5.6nH ±0.3nH	100MHz	300mA	0.26 Ω	8	100MHz	5300MHz
LQG15HN6N2S02□	6.2nH ±0.3nH	100MHz	300mA	0.27 Ω	8	100MHz	4300MHz
LQG15HN6N8J02□	6.8nH ±5%	100MHz	300mA	0.29 Ω	8	100MHz	4200MHz
LQG15HN7N5J02□	7.5nH ±5%	100MHz	300mA	0.31 Ω	8	100MHz	3900MHz
LQG15HN8N2J02□	8.2nH ±5%	100MHz	300mA	0.33 Ω	8	100MHz	3600MHz
LQG15HN9N1J02□	9.1nH ±5%	100MHz	300mA	0.34 Ω	8	100MHz	3400MHz
LQG15HN10NJ02□	10nH ±5%	100MHz	300mA	0.35 Ω	8	100MHz	3200MHz
LQG15HN12NJ02□	12nH ±5%	100MHz	300mA	0.41 Ω	8	100MHz	2800MHz
LQG15HN15NJ02□	15nH ±5%	100MHz	300mA	0.46 Ω	8	100MHz	2300MHz
LQG15HN18NJ02□	18nH ±5%	100MHz	300mA	0.51 Ω	8	100MHz	2100MHz
LQG15HN22NJ02□	22nH ±5%	100MHz	300mA	0.58 Ω	8	100MHz	1800MHz
LQG15HN27NJ02□	27nH ±5%	100MHz	300mA	0.67 Ω	8	100MHz	1600MHz
LQG15HN33NJ02□	33nH ±5%	100MHz	200mA	0.67 Ω	8	100MHz	1500MHz
LQG15HN39NJ02□	39nH ±5%	100MHz	200mA	1.06 Ω	8	100MHz	1200MHz

Operating Temperature Range (Self-temperature rise is not included): -55°C~+125°C
For reflow soldering only.

Continued on the following page.

⚠Note • Please read rating and ⚠CAUTION (for storage, operating, rating, soldering, mounting and handling) in this catalog to prevent smoking and/or burning, etc.
• This catalog has only typical specifications. Therefore, please approve our product specifications or transact the approval sheet for product specifications before ordering.

Part Number	Inductance	Inductance Test Frequency	Rated Current	Max. of DC Resistance	Q (min.)	Q Test Frequency	Self-Resonance Frequency (min.)
LQG15HN47NJ02□	47nH ±5%	100MHz	200mA	1.15 Ω	8	100MHz	1000MHz
LQG15HN56NJ02□	56nH ±5%	100MHz	200mA	1.20 Ω	8	100MHz	800MHz
LQG15HN68NJ02□	68nH ±5%	100MHz	180mA	1.25 Ω	8	100MHz	800MHz
LQG15HN82NJ02□	82nH ±5%	100MHz	150mA	1.60 Ω	8	100MHz	600MHz
LQG15HNR10J02□	100nH ±5%	100MHz	150mA	1.60 Ω	8	100MHz	600MHz
LQG15HNR12J02□	120nH ±5%	100MHz	150mA	1.60 Ω	8	100MHz	600MHz

Operating Temperature Range (Self-temperature rise is not included): -55°C~+125°C
 For reflow soldering only.

■ Q-Frequency Characteristics (Typ.)

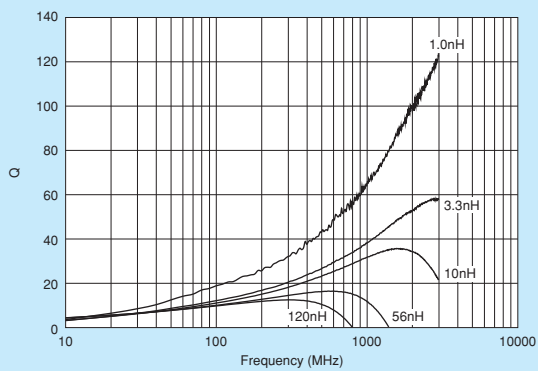

■ Inductance-Frequency Characteristics (Typ.)

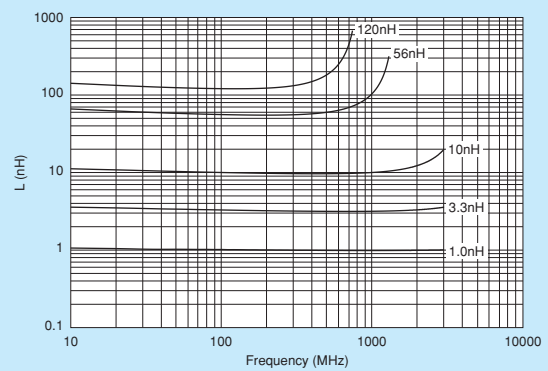

Inductors for Power Lines

Inductors for General Use

Multilayer Type (Non-Magnetic Core)
RF Inductors

△Note • Please read rating and △CAUTION (for storage, operating, rating, soldering, mounting and handling) in this catalog to prevent smoking and/or burning, etc.
 • This catalog has only typical specifications. Therefore, please approve our product specifications or transact the approval sheet for product specifications before ordering.

LQG15HS_02 Series 0402/1005 (inch/mm)

Designed under Industrial Global Standard

■ Appearance/Dimensions

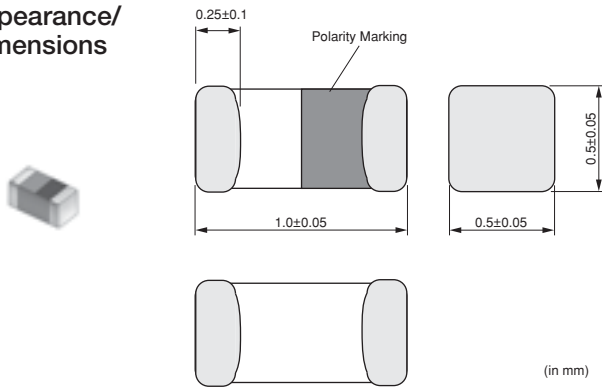

■ Packaging

Code	Packaging	Minimum Quantity
D	ø180mm Paper Taping	10000
J	ø330mm Paper Taping	50000
B	Packing in Bulk	1000



Refer to pages 227 to 230 for mounting information.

■ Rated Value (□: packaging code)

Part Number	Inductance	Inductance Test Frequency	Rated Current	Max. of DC Resistance	Q (min.)	Q Test Frequency	Self-Resonance Frequency (min.)	
LQG15HS1N0S02□	1.0nH ±0.3nH	100MHz	300mA	0.07Ω	8	100MHz	10000MHz	Kit
LQG15HS1N1S02□	1.1nH ±0.3nH	100MHz	300mA	0.09Ω	8	100MHz	6000MHz	Kit
LQG15HS1N2S02□	1.2nH ±0.3nH	100MHz	300mA	0.09Ω	8	100MHz	6000MHz	Kit
LQG15HS1N3S02□	1.3nH ±0.3nH	100MHz	300mA	0.09Ω	8	100MHz	6000MHz	Kit
LQG15HS1N5S02□	1.5nH ±0.3nH	100MHz	300mA	0.10Ω	8	100MHz	6000MHz	Kit
LQG15HS1N6S02□	1.6nH ±0.3nH	100MHz	300mA	0.10Ω	8	100MHz	6000MHz	Kit
LQG15HS1N8S02□	1.8nH ±0.3nH	100MHz	300mA	0.10Ω	8	100MHz	6000MHz	Kit
LQG15HS2N0S02□	2.0nH ±0.3nH	100MHz	300mA	0.10Ω	8	100MHz	6000MHz	Kit
LQG15HS2N2S02□	2.2nH ±0.3nH	100MHz	300mA	0.12Ω	8	100MHz	6000MHz	Kit
LQG15HS2N4S02□	2.4nH ±0.3nH	100MHz	300mA	0.15Ω	8	100MHz	6000MHz	Kit
LQG15HS2N7S02□	2.7nH ±0.3nH	100MHz	300mA	0.15Ω	8	100MHz	6000MHz	Kit
LQG15HS3N0S02□	3.0nH ±0.3nH	100MHz	300mA	0.17Ω	8	100MHz	6000MHz	Kit
LQG15HS3N3S02□	3.3nH ±0.3nH	100MHz	300mA	0.17Ω	8	100MHz	6000MHz	Kit
LQG15HS3N6S02□	3.6nH ±0.3nH	100MHz	300mA	0.18Ω	8	100MHz	6000MHz	Kit
LQG15HS3N9S02□	3.9nH ±0.3nH	100MHz	300mA	0.18Ω	8	100MHz	6000MHz	Kit
LQG15HS4N3S02□	4.3nH ±0.3nH	100MHz	300mA	0.18Ω	8	100MHz	6000MHz	Kit
LQG15HS4N7S02□	4.7nH ±0.3nH	100MHz	300mA	0.18Ω	8	100MHz	6000MHz	Kit
LQG15HS5N1S02□	5.1nH ±0.3nH	100MHz	300mA	0.20Ω	8	100MHz	5300MHz	Kit
LQG15HS5N6S02□	5.6nH ±0.3nH	100MHz	300mA	0.20Ω	8	100MHz	4500MHz	Kit
LQG15HS6N2S02□	6.2nH ±0.3nH	100MHz	300mA	0.22Ω	8	100MHz	4500MHz	Kit
LQG15HS6N8J02□	6.8nH ±5%	100MHz	300mA	0.24Ω	8	100MHz	4500MHz	Kit
LQG15HS7N5J02□	7.5nH ±5%	100MHz	300mA	0.24Ω	8	100MHz	4200MHz	Kit
LQG15HS8N2J02□	8.2nH ±5%	100MHz	300mA	0.24Ω	8	100MHz	3700MHz	Kit
LQG15HS9N1J02□	9.1nH ±5%	100MHz	300mA	0.26Ω	8	100MHz	3400MHz	Kit
LQG15HS10N0J02□	10nH ±5%	100MHz	300mA	0.26Ω	8	100MHz	3400MHz	Kit
LQG15HS12N0J02□	12nH ±5%	100MHz	300mA	0.28Ω	8	100MHz	3000MHz	Kit
LQG15HS15N0J02□	15nH ±5%	100MHz	300mA	0.32Ω	8	100MHz	2500MHz	Kit
LQG15HS18N0J02□	18nH ±5%	100MHz	300mA	0.36Ω	8	100MHz	2200MHz	Kit
LQG15HS22N0J02□	22nH ±5%	100MHz	300mA	0.42Ω	8	100MHz	1900MHz	Kit
LQG15HS27N0J02□	27nH ±5%	100MHz	300mA	0.46Ω	8	100MHz	1700MHz	Kit
LQG15HS33N0J02□	33nH ±5%	100MHz	200mA	0.58Ω	8	100MHz	1600MHz	Kit
LQG15HS39N0J02□	39nH ±5%	100MHz	200mA	0.65Ω	8	100MHz	1200MHz	Kit

Operating Temperature Range (Self-temperature rise is not included): -55°C~+125°C
For reflow soldering only.

Continued on the following page.

△Note • Please read rating and △CAUTION (for storage, operating, rating, soldering, mounting and handling) in this catalog to prevent smoking and/or burning, etc.
• This catalog has only typical specifications. Therefore, please approve our product specifications or transact the approval sheet for product specifications before ordering.

Part Number	Inductance	Inductance Test Frequency	Rated Current	Max. of DC Resistance	Q (min.)	Q Test Frequency	Self-Resonance Frequency (min.)	
LQG15HS47NJ02□	47nH ±5%	100MHz	200mA	0.72Ω	8	100MHz	1000MHz	Kit
LQG15HS56NJ02□	56nH ±5%	100MHz	200mA	0.82Ω	8	100MHz	800MHz	Kit
LQG15HS68NJ02□	68nH ±5%	100MHz	180mA	0.92Ω	8	100MHz	800MHz	Kit
LQG15HS82NJ02□	82nH ±5%	100MHz	150mA	1.20Ω	8	100MHz	700MHz	Kit
LQG15HSR10J02□	100nH ±5%	100MHz	150mA	1.25Ω	8	100MHz	600MHz	Kit
LQG15HSR12J02□	120nH ±5%	100MHz	150mA	1.30Ω	8	100MHz	600MHz	Kit
LQG15HSR15J02□	150nH ±5%	100MHz	140mA	2.99Ω	8	100MHz	550MHz	Kit
LQG15HSR18J02□	180nH ±5%	100MHz	130mA	3.38Ω	8	100MHz	500MHz	Kit
LQG15HSR22J02□	220nH ±5%	100MHz	120mA	3.77Ω	8	100MHz	450MHz	Kit
LQG15HSR27J02□	270nH ±5%	100MHz	110mA	4.94Ω	8	100MHz	400MHz	Kit

Operating Temperature Range (Self-temperature rise is not included): -55°C~+125°C
For reflow soldering only.

■ Q-Frequency Characteristics (Typ.)

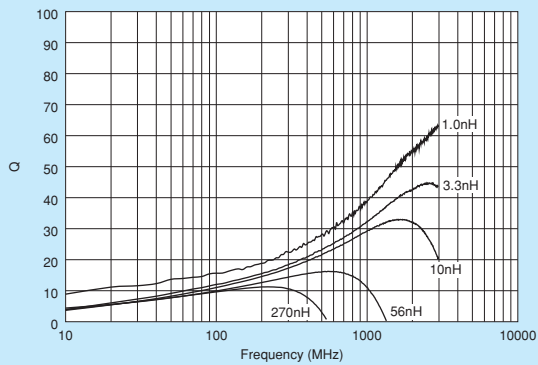

■ Inductance-Frequency Characteristics (Typ.)

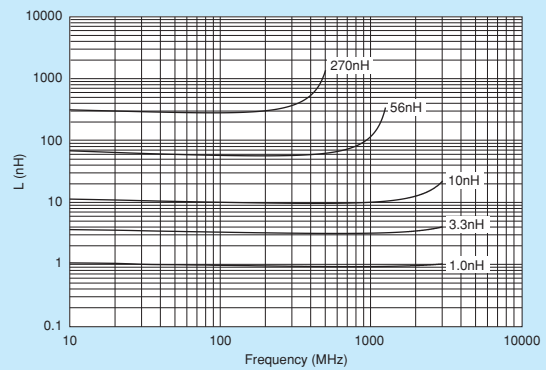

Continued on the following page.

△Note • Please read rating and △CAUTION (for storage, operating, rating, soldering, mounting and handling) in this catalog to prevent smoking and/or burning, etc.
• This catalog has only typical specifications. Therefore, please approve our product specifications or transact the approval sheet for product specifications before ordering.

■ Reference Data

4991A&16196D

Part Number	Q (Typ.)				
	800MHz	900MHz	1.8GHz	2.0GHz	2.4GHz
LQG15HS1N0□02	32	34	49	52	55
LQG15HS1N1□02	24	26	41	43	47
LQG15HS1N2□02	29	31	47	49	53
LQG15HS1N3□02	35	37	51	53	54
LQG15HS1N5□02	31	32	46	49	51
LQG15HS1N6□02	31	33	48	50	52
LQG15HS1N8□02	31	33	47	48	50
LQG15HS2N0□02	33	35	47	48	49
LQG15HS2N2□02	29	31	44	45	46
LQG15HS2N4□02	28	29	42	44	47
LQG15HS2N7□02	29	30	43	44	47
LQG15HS3N0□02	28	30	42	44	47
LQG15HS3N3□02	29	31	42	43	44
LQG15HS3N6□02	28	29	42	43	46
LQG15HS3N9□02	28	29	40	41	44
LQG15HS4N3□02	27	29	39	40	42
LQG15HS4N7□02	28	29	39	40	41
LQG15HS5N1□02	28	30	39	40	41
LQG15HS5N6□02	28	29	36	36	35
LQG15HS6N2□02	26	28	36	36	36
LQG15HS6N8□02	26	28	36	36	35
LQG15HS7N5□02	27	28	35	35	33
LQG15HS8N2□02	27	28	33	32	29
LQG15HS9N1□02	26	27	33	32	29
LQG15HS10N□02	26	28	33	32	29
LQG15HS12N□02	25	26	26	24	17
LQG15HS15N□02	24	25	22	19	11
LQG15HS18N□02	24	25	21	18	-
LQG15HS22N□02	23	24	17	-	-
LQG15HS27N□02	21	21	-	-	-
LQG15HS33N□02	20	20	-	-	-
LQG15HS39N□02	19	19	-	-	-
LQG15HS47N□02	17	16	-	-	-
LQG15HS56N□02	15	13	-	-	-
LQG15HS68N□02	12	10	-	-	-
LQG15HS82N□02	9	6	-	-	-
LQG15HSR10□02	-	-	-	-	-
LQG15HSR12□02	-	-	-	-	-

△Note • Please read rating and △CAUTION (for storage, operating, rating, soldering, mounting and handling) in this catalog to prevent smoking and/or burning, etc.
 • This catalog has only typical specifications. Therefore, please approve our product specifications or transact the approval sheet for product specifications before ordering.

LQG18HN_00 Series 0603/1608 (inch/mm)

Size Code 0603 (1608) in inch (in mm), Multilayer Type

■ Appearance/Dimensions

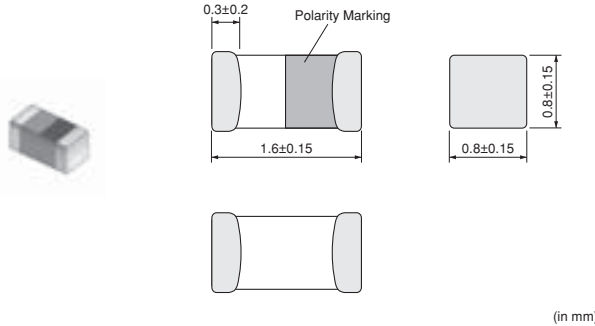

■ Packaging

Code	Packaging	Minimum Quantity
D	ø180mm Paper Taping	4000
J	ø330mm Paper Taping	10000
B	Packing in Bulk	1000



Refer to pages 227 to 230 for mounting information.

■ Rated Value (□: packaging code)

Part Number	Inductance	Inductance Test Frequency	Rated Current	Max. of DC Resistance	Q (min.)	Q Test Frequency	Self-Resonance Frequency (min.)	
LQG18HN1N2S00□	1.2nH ±0.3nH	100MHz	500mA	0.10Ω	12	100MHz	6000MHz	Kit
LQG18HN1N5S00□	1.5nH ±0.3nH	100MHz	500mA	0.10Ω	12	100MHz	6000MHz	Kit
LQG18HN1N8S00□	1.8nH ±0.3nH	100MHz	500mA	0.10Ω	12	100MHz	6000MHz	Kit
LQG18HN2N2S00□	2.2nH ±0.3nH	100MHz	500mA	0.10Ω	12	100MHz	6000MHz	Kit
LQG18HN2N7S00□	2.7nH ±0.3nH	100MHz	500mA	0.15Ω	12	100MHz	6000MHz	Kit
LQG18HN3N3S00□	3.3nH ±0.3nH	100MHz	500mA	0.15Ω	12	100MHz	6000MHz	Kit
LQG18HN3N9S00□	3.9nH ±0.3nH	100MHz	450mA	0.15Ω	12	100MHz	6000MHz	Kit
LQG18HN4N7S00□	4.7nH ±0.3nH	100MHz	450mA	0.20Ω	12	100MHz	6000MHz	Kit
LQG18HN5N6S00□	5.6nH ±0.3nH	100MHz	430mA	0.20Ω	12	100MHz	5000MHz	Kit
LQG18HN6N8J00□	6.8nH ±5%	100MHz	430mA	0.25Ω	12	100MHz	5000MHz	Kit
LQG18HN8N2J00□	8.2nH ±5%	100MHz	400mA	0.25Ω	12	100MHz	4000MHz	Kit
LQG18HN10NJ00□	10nH ±5%	100MHz	400mA	0.30Ω	12	100MHz	3500MHz	Kit
LQG18HN12NJ00□	12nH ±5%	100MHz	400mA	0.35Ω	12	100MHz	3000MHz	Kit
LQG18HN15NJ00□	15nH ±5%	100MHz	350mA	0.40Ω	12	100MHz	2800MHz	Kit
LQG18HN18NJ00□	18nH ±5%	100MHz	350mA	0.45Ω	12	100MHz	2600MHz	Kit
LQG18HN22NJ00□	22nH ±5%	100MHz	300mA	0.50Ω	12	100MHz	2300MHz	Kit
LQG18HN27NJ00□	27nH ±5%	100MHz	300mA	0.55Ω	12	100MHz	2000MHz	Kit
LQG18HN33NJ00□	33nH ±5%	100MHz	300mA	0.60Ω	12	100MHz	1700MHz	Kit
LQG18HN39NJ00□	39nH ±5%	100MHz	300mA	0.65Ω	12	100MHz	1500MHz	Kit
LQG18HN47NJ00□	47nH ±5%	100MHz	300mA	0.70Ω	12	100MHz	1200MHz	Kit
LQG18HN56NJ00□	56nH ±5%	100MHz	300mA	0.75Ω	12	100MHz	1100MHz	Kit
LQG18HN68NJ00□	68nH ±5%	100MHz	300mA	0.80Ω	12	100MHz	1000MHz	Kit
LQG18HN82NJ00□	82nH ±5%	100MHz	300mA	0.85Ω	12	100MHz	900MHz	Kit
LQG18HNR10J00□	100nH ±5%	100MHz	300mA	0.90Ω	12	100MHz	800MHz	Kit

Operating Temperature Range (Self-temperature rise is not included): -40°C~+85°C
For reflow soldering only.

Continued on the following page. ↗

△Note • Please read rating and △CAUTION (for storage, operating, rating, soldering, mounting and handling) in this catalog to prevent smoking and/or burning, etc.
• This catalog has only typical specifications. Therefore, please approve our product specifications or transact the approval sheet for product specifications before ordering.

■ Q-Frequency Characteristics (Typ.)

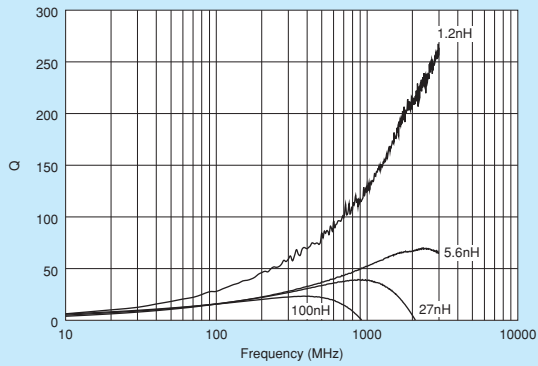

■ Inductance-Frequency Characteristics (Typ.)

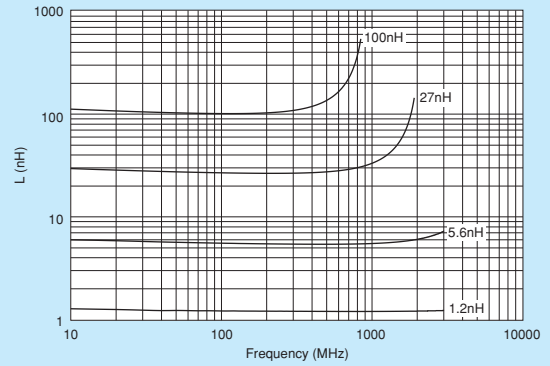

⚠Note • Please read rating and ⚠CAUTION (for storage, operating, rating, soldering, mounting and handling) in this catalog to prevent smoking and/or burning, etc.
• This catalog has only typical specifications. Therefore, please approve our product specifications or transact the approval sheet for product specifications before ordering.

LQP02TN_02 Series 01005/0402 (inch/mm)

Size Code 01005 (0402) in inch (in mm)

■ Appearance/ Dimensions

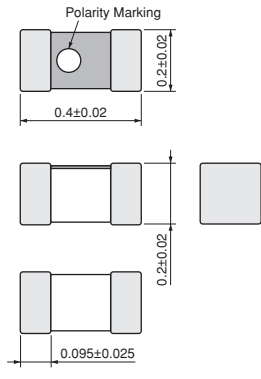

(in mm)

■ Packaging

Code	Packaging	Minimum Quantity
D	ø180mm Paper Taping	20000
B	Packing in Bulk	500



Refer to pages 227 to 230 for mounting information.

■ Rated Value (□: packaging code)

Part Number	Inductance	Inductance Test Frequency	Rated Current	Max. of DC Resistance	Q (min.)	Q Test Frequency	Self-Resonance Frequency (min.)	
LQP02TN0N2B02□	0.2nH ±0.1nH	500MHz	320mA	0.50Ω	-	-	20000MHz	Kit
LQP02TN0N2C02□	0.2nH ±0.2nH	500MHz	320mA	0.50Ω	-	-	20000MHz	
LQP02TN0N3B02□	0.3nH ±0.1nH	500MHz	320mA	0.50Ω	-	-	20000MHz	Kit
LQP02TN0N3C02□	0.3nH ±0.2nH	500MHz	320mA	0.50Ω	-	-	20000MHz	
LQP02TN0N4B02□	0.4nH ±0.1nH	500MHz	320mA	0.50Ω	8	500MHz	18000MHz	Kit
LQP02TN0N4C02□	0.4nH ±0.2nH	500MHz	320mA	0.50Ω	8	500MHz	18000MHz	
LQP02TN0N4S02□	0.4nH ±0.3nH	500MHz	320mA	0.50Ω	8	500MHz	18000MHz	
LQP02TN0N5B02□	0.5nH ±0.1nH	500MHz	320mA	0.50Ω	8	500MHz	18000MHz	Kit
LQP02TN0N5C02□	0.5nH ±0.2nH	500MHz	320mA	0.50Ω	8	500MHz	18000MHz	
LQP02TN0N5S02□	0.5nH ±0.3nH	500MHz	320mA	0.50Ω	8	500MHz	18000MHz	
LQP02TN0N6B02□	0.6nH ±0.1nH	500MHz	320mA	0.50Ω	8	500MHz	17000MHz	Kit
LQP02TN0N6C02□	0.6nH ±0.2nH	500MHz	320mA	0.50Ω	8	500MHz	17000MHz	
LQP02TN0N6S02□	0.6nH ±0.3nH	500MHz	320mA	0.50Ω	8	500MHz	17000MHz	
LQP02TN0N7B02□	0.7nH ±0.1nH	500MHz	320mA	0.50Ω	8	500MHz	16500MHz	Kit
LQP02TN0N7C02□	0.7nH ±0.2nH	500MHz	320mA	0.50Ω	8	500MHz	16500MHz	
LQP02TN0N7S02□	0.7nH ±0.3nH	500MHz	320mA	0.50Ω	8	500MHz	16500MHz	
LQP02TN0N8B02□	0.8nH ±0.1nH	500MHz	320mA	0.50Ω	8	500MHz	16500MHz	Kit
LQP02TN0N8C02□	0.8nH ±0.2nH	500MHz	320mA	0.50Ω	8	500MHz	16500MHz	
LQP02TN0N8S02□	0.8nH ±0.3nH	500MHz	320mA	0.50Ω	8	500MHz	16500MHz	
LQP02TN0N9B02□	0.9nH ±0.1nH	500MHz	320mA	0.50Ω	8	500MHz	13000MHz	Kit
LQP02TN0N9C02□	0.9nH ±0.2nH	500MHz	320mA	0.50Ω	8	500MHz	13000MHz	
LQP02TN0N9S02□	0.9nH ±0.3nH	500MHz	320mA	0.50Ω	8	500MHz	13000MHz	
LQP02TN1N0B02□	1.0nH ±0.1nH	500MHz	220mA	0.60Ω	8	500MHz	13000MHz	Kit
LQP02TN1N0C02□	1.0nH ±0.2nH	500MHz	220mA	0.60Ω	8	500MHz	13000MHz	
LQP02TN1N0S02□	1.0nH ±0.3nH	500MHz	220mA	0.60Ω	8	500MHz	13000MHz	
LQP02TN1N1B02□	1.1nH ±0.1nH	500MHz	220mA	0.60Ω	8	500MHz	12500MHz	Kit
LQP02TN1N1C02□	1.1nH ±0.2nH	500MHz	220mA	0.60Ω	8	500MHz	12500MHz	
LQP02TN1N1S02□	1.1nH ±0.3nH	500MHz	220mA	0.60Ω	8	500MHz	12500MHz	
LQP02TN1N2B02□	1.2nH ±0.1nH	500MHz	220mA	0.60Ω	8	500MHz	12500MHz	Kit
LQP02TN1N2C02□	1.2nH ±0.2nH	500MHz	220mA	0.60Ω	8	500MHz	12500MHz	
LQP02TN1N2S02□	1.2nH ±0.3nH	500MHz	220mA	0.60Ω	8	500MHz	12500MHz	
LQP02TN1N3B02□	1.3nH ±0.1nH	500MHz	220mA	0.60Ω	8	500MHz	11500MHz	Kit

Operating Temperature Range (Self-temperature rise is not included): -55°C~+125°C
For reflow soldering only.

Continued on the following page.

△Note • Please read rating and △CAUTION (for storage, operating, rating, soldering, mounting and handling) in this catalog to prevent smoking and/or burning, etc.
• This catalog has only typical specifications. Therefore, please approve our product specifications or transact the approval sheet for product specifications before ordering.

Part Number	Inductance	Inductance Test Frequency	Rated Current	Max. of DC Resistance	Q (min.)	Q Test Frequency	Self-Resonance Frequency (min.)	
LQP02TN1N3C02□	1.3nH ±0.2nH	500MHz	220mA	0.60Ω	8	500MHz	11500MHz	
LQP02TN1N3S02□	1.3nH ±0.3nH	500MHz	220mA	0.60Ω	8	500MHz	11500MHz	
LQP02TN1N4B02□	1.4nH ±0.1nH	500MHz	220mA	0.60Ω	8	500MHz	11500MHz	Kit
LQP02TN1N4C02□	1.4nH ±0.2nH	500MHz	220mA	0.60Ω	8	500MHz	11500MHz	
LQP02TN1N4S02□	1.4nH ±0.3nH	500MHz	220mA	0.60Ω	8	500MHz	11500MHz	
LQP02TN1N5B02□	1.5nH ±0.1nH	500MHz	220mA	0.60Ω	8	500MHz	9500MHz	Kit
LQP02TN1N5C02□	1.5nH ±0.2nH	500MHz	220mA	0.60Ω	8	500MHz	9500MHz	
LQP02TN1N5S02□	1.5nH ±0.3nH	500MHz	220mA	0.60Ω	8	500MHz	9500MHz	
LQP02TN1N6B02□	1.6nH ±0.1nH	500MHz	220mA	0.60Ω	8	500MHz	9500MHz	Kit
LQP02TN1N6C02□	1.6nH ±0.2nH	500MHz	220mA	0.60Ω	8	500MHz	9500MHz	
LQP02TN1N6S02□	1.6nH ±0.3nH	500MHz	220mA	0.60Ω	8	500MHz	9500MHz	
LQP02TN1N7B02□	1.7nH ±0.1nH	500MHz	200mA	0.70Ω	8	500MHz	9500MHz	Kit
LQP02TN1N7C02□	1.7nH ±0.2nH	500MHz	200mA	0.70Ω	8	500MHz	9500MHz	
LQP02TN1N7S02□	1.7nH ±0.3nH	500MHz	200mA	0.70Ω	8	500MHz	9500MHz	
LQP02TN1N8B02□	1.8nH ±0.1nH	500MHz	200mA	0.70Ω	8	500MHz	9000MHz	Kit
LQP02TN1N8C02□	1.8nH ±0.2nH	500MHz	200mA	0.70Ω	8	500MHz	9000MHz	
LQP02TN1N8S02□	1.8nH ±0.3nH	500MHz	200mA	0.70Ω	8	500MHz	9000MHz	
LQP02TN1N9B02□	1.9nH ±0.1nH	500MHz	200mA	0.75Ω	8	500MHz	9000MHz	Kit
LQP02TN1N9C02□	1.9nH ±0.2nH	500MHz	200mA	0.75Ω	8	500MHz	9000MHz	
LQP02TN1N9S02□	1.9nH ±0.3nH	500MHz	200mA	0.75Ω	8	500MHz	9000MHz	
LQP02TN2N0B02□	2.0nH ±0.1nH	500MHz	200mA	0.75Ω	8	500MHz	9000MHz	Kit
LQP02TN2N0C02□	2.0nH ±0.2nH	500MHz	200mA	0.75Ω	8	500MHz	9000MHz	
LQP02TN2N0S02□	2.0nH ±0.3nH	500MHz	200mA	0.75Ω	8	500MHz	9000MHz	
LQP02TN2N1B02□	2.1nH ±0.1nH	500MHz	200mA	0.75Ω	8	500MHz	9000MHz	Kit
LQP02TN2N1C02□	2.1nH ±0.2nH	500MHz	200mA	0.75Ω	8	500MHz	9000MHz	
LQP02TN2N1S02□	2.1nH ±0.3nH	500MHz	200mA	0.75Ω	8	500MHz	9000MHz	
LQP02TN2N2B02□	2.2nH ±0.1nH	500MHz	200mA	0.75Ω	8	500MHz	7500MHz	Kit
LQP02TN2N2C02□	2.2nH ±0.2nH	500MHz	200mA	0.75Ω	8	500MHz	7500MHz	
LQP02TN2N2S02□	2.2nH ±0.3nH	500MHz	200mA	0.75Ω	8	500MHz	7500MHz	
LQP02TN2N3B02□	2.3nH ±0.1nH	500MHz	200mA	0.75Ω	8	500MHz	7500MHz	Kit
LQP02TN2N3C02□	2.3nH ±0.2nH	500MHz	200mA	0.75Ω	8	500MHz	7500MHz	
LQP02TN2N3S02□	2.3nH ±0.3nH	500MHz	200mA	0.75Ω	8	500MHz	7500MHz	
LQP02TN2N4B02□	2.4nH ±0.1nH	500MHz	200mA	0.75Ω	8	500MHz	7500MHz	Kit
LQP02TN2N4C02□	2.4nH ±0.2nH	500MHz	200mA	0.75Ω	8	500MHz	7500MHz	
LQP02TN2N4S02□	2.4nH ±0.3nH	500MHz	200mA	0.75Ω	8	500MHz	7500MHz	
LQP02TN2N5B02□	2.5nH ±0.1nH	500MHz	200mA	0.80Ω	8	500MHz	7500MHz	Kit
LQP02TN2N5C02□	2.5nH ±0.2nH	500MHz	200mA	0.80Ω	8	500MHz	7500MHz	
LQP02TN2N5S02□	2.5nH ±0.3nH	500MHz	200mA	0.80Ω	8	500MHz	7500MHz	
LQP02TN2N6B02□	2.6nH ±0.1nH	500MHz	200mA	0.80Ω	8	500MHz	7500MHz	Kit
LQP02TN2N6C02□	2.6nH ±0.2nH	500MHz	200mA	0.80Ω	8	500MHz	7500MHz	
LQP02TN2N6S02□	2.6nH ±0.3nH	500MHz	200mA	0.80Ω	8	500MHz	7500MHz	
LQP02TN2N7B02□	2.7nH ±0.1nH	500MHz	200mA	0.80Ω	8	500MHz	7500MHz	Kit
LQP02TN2N7C02□	2.7nH ±0.2nH	500MHz	200mA	0.80Ω	8	500MHz	7500MHz	
LQP02TN2N7S02□	2.7nH ±0.3nH	500MHz	200mA	0.80Ω	8	500MHz	7500MHz	
LQP02TN2N8B02□	2.8nH ±0.1nH	500MHz	200mA	1.10Ω	8	500MHz	7500MHz	Kit
LQP02TN2N8C02□	2.8nH ±0.2nH	500MHz	200mA	1.10Ω	8	500MHz	7500MHz	
LQP02TN2N8S02□	2.8nH ±0.3nH	500MHz	200mA	1.10Ω	8	500MHz	7500MHz	

Operating Temperature Range (Self-temperature rise is not included): -55°C~+125°C
For reflow soldering only.

Continued on the following page. 

△Note • Please read rating and △CAUTION (for storage, operating, rating, soldering, mounting and handling) in this catalog to prevent smoking and/or burning, etc.
• This catalog has only typical specifications. Therefore, please approve our product specifications or transact the approval sheet for product specifications before ordering.

O05E.pdf
Nov.25,2013

Part Number	Inductance	Inductance Test Frequency	Rated Current	Max. of DC Resistance	Q (min.)	Q Test Frequency	Self-Resonance Frequency (min.)	
LQP02TN2N9B02□	2.9nH ±0.1nH	500MHz	200mA	1.10Ω	8	500MHz	7500MHz	Kit
LQP02TN2N9C02□	2.9nH ±0.2nH	500MHz	200mA	1.10Ω	8	500MHz	7500MHz	
LQP02TN2N9S02□	2.9nH ±0.3nH	500MHz	200mA	1.10Ω	8	500MHz	7500MHz	
LQP02TN3N0B02□	3.0nH ±0.1nH	500MHz	200mA	1.10Ω	8	500MHz	7500MHz	Kit
LQP02TN3N0C02□	3.0nH ±0.2nH	500MHz	200mA	1.10Ω	8	500MHz	7500MHz	
LQP02TN3N0S02□	3.0nH ±0.3nH	500MHz	200mA	1.10Ω	8	500MHz	7500MHz	
LQP02TN3N1B02□	3.1nH ±0.1nH	500MHz	180mA	1.30Ω	8	500MHz	7500MHz	Kit
LQP02TN3N1C02□	3.1nH ±0.2nH	500MHz	180mA	1.30Ω	8	500MHz	7500MHz	
LQP02TN3N1S02□	3.1nH ±0.3nH	500MHz	180mA	1.30Ω	8	500MHz	7500MHz	
LQP02TN3N2B02□	3.2nH ±0.1nH	500MHz	180mA	1.30Ω	8	500MHz	7500MHz	Kit
LQP02TN3N2C02□	3.2nH ±0.2nH	500MHz	180mA	1.30Ω	8	500MHz	7500MHz	
LQP02TN3N2S02□	3.2nH ±0.3nH	500MHz	180mA	1.30Ω	8	500MHz	7500MHz	
LQP02TN3N3B02□	3.3nH ±0.1nH	500MHz	180mA	1.30Ω	8	500MHz	7500MHz	Kit
LQP02TN3N3C02□	3.3nH ±0.2nH	500MHz	180mA	1.30Ω	8	500MHz	7500MHz	
LQP02TN3N3S02□	3.3nH ±0.3nH	500MHz	180mA	1.30Ω	8	500MHz	7500MHz	
LQP02TN3N4B02□	3.4nH ±0.1nH	500MHz	180mA	1.30Ω	8	500MHz	7500MHz	Kit
LQP02TN3N4C02□	3.4nH ±0.2nH	500MHz	180mA	1.30Ω	8	500MHz	7500MHz	
LQP02TN3N4S02□	3.4nH ±0.3nH	500MHz	180mA	1.30Ω	8	500MHz	7500MHz	
LQP02TN3N5B02□	3.5nH ±0.1nH	500MHz	180mA	1.30Ω	8	500MHz	7500MHz	Kit
LQP02TN3N5C02□	3.5nH ±0.2nH	500MHz	180mA	1.30Ω	8	500MHz	7500MHz	
LQP02TN3N5S02□	3.5nH ±0.3nH	500MHz	180mA	1.30Ω	8	500MHz	7500MHz	
LQP02TN3N6B02□	3.6nH ±0.1nH	500MHz	180mA	1.30Ω	8	500MHz	7500MHz	Kit
LQP02TN3N6C02□	3.6nH ±0.2nH	500MHz	180mA	1.30Ω	8	500MHz	7500MHz	
LQP02TN3N6S02□	3.6nH ±0.3nH	500MHz	180mA	1.30Ω	8	500MHz	7500MHz	
LQP02TN3N7B02□	3.7nH ±0.1nH	500MHz	180mA	1.30Ω	8	500MHz	7500MHz	Kit
LQP02TN3N7C02□	3.7nH ±0.2nH	500MHz	180mA	1.30Ω	8	500MHz	7500MHz	
LQP02TN3N7S02□	3.7nH ±0.3nH	500MHz	180mA	1.30Ω	8	500MHz	7500MHz	
LQP02TN3N8B02□	3.8nH ±0.1nH	500MHz	180mA	1.30Ω	8	500MHz	7500MHz	Kit
LQP02TN3N8C02□	3.8nH ±0.2nH	500MHz	180mA	1.30Ω	8	500MHz	7500MHz	
LQP02TN3N8S02□	3.8nH ±0.3nH	500MHz	180mA	1.30Ω	8	500MHz	7500MHz	
LQP02TN3N9B02□	3.9nH ±0.1nH	500MHz	180mA	1.30Ω	8	500MHz	7500MHz	Kit
LQP02TN3N9C02□	3.9nH ±0.2nH	500MHz	180mA	1.30Ω	8	500MHz	7500MHz	
LQP02TN3N9S02□	3.9nH ±0.3nH	500MHz	180mA	1.30Ω	8	500MHz	7500MHz	
LQP02TN4N0B02□	4.0nH ±0.1nH	500MHz	180mA	1.30Ω	8	500MHz	7500MHz	Kit
LQP02TN4N0C02□	4.0nH ±0.2nH	500MHz	180mA	1.30Ω	8	500MHz	7500MHz	
LQP02TN4N0S02□	4.0nH ±0.3nH	500MHz	180mA	1.30Ω	8	500MHz	7500MHz	
LQP02TN4N1B02□	4.1nH ±0.1nH	500MHz	180mA	1.30Ω	8	500MHz	7500MHz	Kit
LQP02TN4N1C02□	4.1nH ±0.2nH	500MHz	180mA	1.30Ω	8	500MHz	7500MHz	
LQP02TN4N1S02□	4.1nH ±0.3nH	500MHz	180mA	1.30Ω	8	500MHz	7500MHz	
LQP02TN4N2B02□	4.2nH ±0.1nH	500MHz	180mA	1.30Ω	8	500MHz	7000MHz	Kit
LQP02TN4N2C02□	4.2nH ±0.2nH	500MHz	180mA	1.30Ω	8	500MHz	7000MHz	
LQP02TN4N2S02□	4.2nH ±0.3nH	500MHz	180mA	1.30Ω	8	500MHz	7000MHz	
LQP02TN4N3H02□	4.3nH ±3%	500MHz	180mA	1.30Ω	8	500MHz	7000MHz	Kit
LQP02TN4N3J02□	4.3nH ±5%	500MHz	180mA	1.30Ω	8	500MHz	7000MHz	
LQP02TN4N3S02□	4.3nH ±0.3nH	500MHz	180mA	1.30Ω	8	500MHz	7000MHz	
LQP02TN4N7H02□	4.7nH ±3%	500MHz	160mA	1.50Ω	8	500MHz	6500MHz	Kit
LQP02TN4N7J02□	4.7nH ±5%	500MHz	160mA	1.50Ω	8	500MHz	6500MHz	

Operating Temperature Range (Self-temperature rise is not included): -55°C~+125°C
For reflow soldering only.

Continued on the following page. 

△Note • Please read rating and △CAUTION (for storage, operating, rating, soldering, mounting and handling) in this catalog to prevent smoking and/or burning, etc.
• This catalog has only typical specifications. Therefore, please approve our product specifications or transact the approval sheet for product specifications before ordering.

Part Number	Inductance	Inductance Test Frequency	Rated Current	Max. of DC Resistance	Q (min.)	Q Test Frequency	Self-Resonance Frequency (min.)	
LQP02TN4N7S02□	4.7nH ±0.3nH	500MHz	160mA	1.50Ω	8	500MHz	6500MHz	
LQP02TN5N1H02□	5.1nH ±3%	500MHz	160mA	1.50Ω	8	500MHz	6500MHz	Kit
LQP02TN5N1J02□	5.1nH ±5%	500MHz	160mA	1.50Ω	8	500MHz	6500MHz	
LQP02TN5N1S02□	5.1nH ±0.3nH	500MHz	160mA	1.50Ω	8	500MHz	6500MHz	
LQP02TN5N6H02□	5.6nH ±3%	500MHz	140mA	1.80Ω	8	500MHz	6000MHz	Kit
LQP02TN5N6J02□	5.6nH ±5%	500MHz	140mA	1.80Ω	8	500MHz	6000MHz	
LQP02TN5N6S02□	5.6nH ±0.3nH	500MHz	140mA	1.80Ω	8	500MHz	6000MHz	
LQP02TN6N2H02□	6.2nH ±3%	500MHz	140mA	1.80Ω	8	500MHz	5500MHz	Kit
LQP02TN6N2J02□	6.2nH ±5%	500MHz	140mA	1.80Ω	8	500MHz	5500MHz	
LQP02TN6N8H02□	6.8nH ±3%	500MHz	140mA	2.00Ω	8	500MHz	5500MHz	Kit
LQP02TN6N8J02□	6.8nH ±5%	500MHz	140mA	2.00Ω	8	500MHz	5500MHz	
LQP02TN7N5H02□	7.5nH ±3%	500MHz	140mA	2.00Ω	8	500MHz	4500MHz	Kit
LQP02TN7N5J02□	7.5nH ±5%	500MHz	140mA	2.00Ω	8	500MHz	4500MHz	
LQP02TN8N2H02□	8.2nH ±3%	500MHz	140mA	2.10Ω	8	500MHz	4500MHz	Kit
LQP02TN8N2J02□	8.2nH ±5%	500MHz	140mA	2.10Ω	8	500MHz	4500MHz	
LQP02TN9N1H02□	9.1nH ±3%	500MHz	140mA	2.10Ω	8	500MHz	4000MHz	Kit
LQP02TN9N1J02□	9.1nH ±5%	500MHz	140mA	2.10Ω	8	500MHz	4000MHz	
LQP02TN10NH02□	10nH ±3%	500MHz	140mA	2.50Ω	8	500MHz	4000MHz	Kit
LQP02TN10NJ02□	10nH ±5%	500MHz	140mA	2.50Ω	8	500MHz	4000MHz	
LQP02TN11NH02□	11nH ±3%	500MHz	140mA	2.80Ω	7	500MHz	3500MHz	Kit
LQP02TN11NJ02□	11nH ±5%	500MHz	140mA	2.80Ω	7	500MHz	3500MHz	
LQP02TN12NH02□	12nH ±3%	500MHz	140mA	2.80Ω	7	500MHz	3500MHz	Kit
LQP02TN12NJ02□	12nH ±5%	500MHz	140mA	2.80Ω	7	500MHz	3500MHz	
LQP02TN13NH02□	13nH ±3%	500MHz	140mA	3.20Ω	7	500MHz	3000MHz	Kit
LQP02TN13NJ02□	13nH ±5%	500MHz	140mA	3.20Ω	7	500MHz	3000MHz	
LQP02TN15NH02□	15nH ±3%	500MHz	140mA	3.20Ω	7	500MHz	3000MHz	Kit
LQP02TN15NJ02□	15nH ±5%	500MHz	140mA	3.20Ω	7	500MHz	3000MHz	
LQP02TN16NH02□	16nH ±3%	500MHz	140mA	3.50Ω	7	500MHz	2500MHz	Kit
LQP02TN16NJ02□	16nH ±5%	500MHz	140mA	3.50Ω	7	500MHz	2500MHz	
LQP02TN18NH02□	18nH ±3%	500MHz	140mA	3.50Ω	7	500MHz	2500MHz	Kit
LQP02TN18NJ02□	18nH ±5%	500MHz	140mA	3.50Ω	7	500MHz	2500MHz	
LQP02TN20NH02□	20nH ±3%	500MHz	120mA	5.00Ω	6	500MHz	2300MHz	Kit
LQP02TN20NJ02□	20nH ±5%	500MHz	120mA	5.00Ω	6	500MHz	2300MHz	
LQP02TN22NH02□	22nH ±3%	500MHz	120mA	5.00Ω	6	500MHz	2300MHz	New
LQP02TN22NJ02□	22nH ±5%	500MHz	120mA	5.00Ω	6	500MHz	2300MHz	New
LQP02TN24NH02□	24nH ±3%	500MHz	120mA	5.50Ω	6	500MHz	2000MHz	New
LQP02TN24NJ02□	24nH ±5%	500MHz	120mA	5.50Ω	6	500MHz	2000MHz	New
LQP02TN27NH02□	27nH ±3%	500MHz	120mA	5.50Ω	6	500MHz	2000MHz	New
LQP02TN27NJ02□	27nH ±5%	500MHz	120mA	5.50Ω	6	500MHz	2000MHz	New
LQP02TN30NH02□	30nH ±3%	500MHz	90mA	6.50Ω	6	500MHz	1800MHz	New
LQP02TN30NJ02□	30nH ±5%	500MHz	90mA	6.50Ω	6	500MHz	1800MHz	New
LQP02TN33NH02□	33nH ±3%	300MHz	90mA	6.50Ω	4	300MHz	1800MHz	New
LQP02TN33NJ02□	33nH ±5%	300MHz	90mA	6.50Ω	4	300MHz	1800MHz	New
LQP02TN36NH02□	36nH ±3%	300MHz	90mA	7.00Ω	4	300MHz	1600MHz	New
LQP02TN36NJ02□	36nH ±5%	300MHz	90mA	7.00Ω	4	300MHz	1600MHz	New
LQP02TN39NH02□	39nH ±3%	300MHz	90mA	7.00Ω	4	300MHz	1600MHz	New
LQP02TN39NJ02□	39nH ±5%	300MHz	90mA	7.00Ω	4	300MHz	1600MHz	New

Operating Temperature Range (Self-temperature rise is not included): -55°C~+125°C
For reflow soldering only.

Continued on the following page. 

△Note • Please read rating and △CAUTION (for storage, operating, rating, soldering, mounting and handling) in this catalog to prevent smoking and/or burning, etc.
• This catalog has only typical specifications. Therefore, please approve our product specifications or transact the approval sheet for product specifications before ordering.

■ Q-Frequency Characteristics (Typ.)

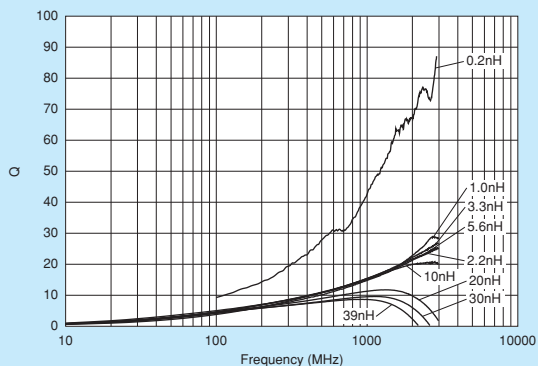

■ Inductance-Frequency Characteristics (Typ.)

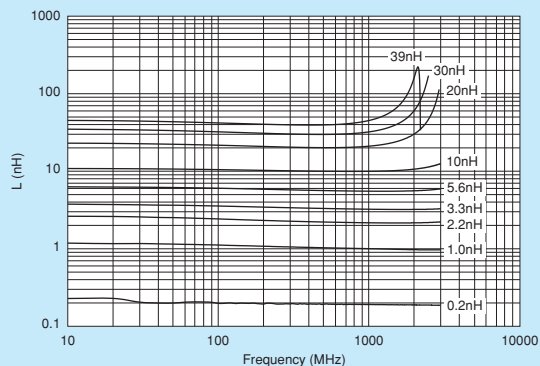

■ Reference Data

4991A&16196D

Part Number	Q (Typ.)				
	800MHz	900MHz	1.8GHz	2.0GHz	2.4GHz
LQP02TN0N2□02	20	40	69	65	74
LQP02TN0N3□02	21	24	37	38	43
LQP02TN0N4□02	13	14	22	24	26
LQP02TN0N5□02	13	14	23	24	27
LQP02TN0N6□02	15	16	25	26	32
LQP02TN0N7□02	14	15	23	24	27
LQP02TN0N8□02	14	15	22	24	27
LQP02TN0N9□02	15	16	23	25	29
LQP02TN1N0□02	13	14	21	23	26
LQP02TN1N1□02	14	15	23	25	28
LQP02TN1N2□02	14	15	22	23	26
LQP02TN1N3□02	14	15	23	24	27
LQP02TN1N4□02	14	15	23	24	27
LQP02TN1N5□02	13	14	21	23	25
LQP02TN1N6□02	14	15	22	24	26
LQP02TN1N7□02	13	14	21	23	25
LQP02TN1N8□02	14	15	22	23	26
LQP02TN1N9□02	14	15	22	23	26
LQP02TN2N0□02	14	15	22	24	26
LQP02TN2N1□02	14	15	22	23	25
LQP02TN2N2□02	13	14	20	21	23
LQP02TN2N3□02	13	14	21	22	24
LQP02TN2N4□02	13	14	21	22	24
LQP02TN2N5□02	14	14	21	22	23
LQP02TN2N6□02	14	15	22	23	25
LQP02TN2N7□02	14	14	22	23	25
LQP02TN2N8□02	11	12	18	19	21
LQP02TN2N9□02	13	14	20	21	23
LQP02TN3N0□02	13	14	20	22	23
LQP02TN3N1□02	12	13	20	21	23
LQP02TN3N2□02	13	13	20	21	23
LQP02TN3N3□02	14	14	21	22	24
LQP02TN3N4□02	13	14	20	22	23

Continued on the following page.

△Note • Please read rating and △CAUTION (for storage, operating, rating, soldering, mounting and handling) in this catalog to prevent smoking and/or burning, etc.
 • This catalog has only typical specifications. Therefore, please approve our product specifications or transact the approval sheet for product specifications before ordering.

Part Number	Q (Typ.)				
	800MHz	900MHz	1.8GHz	2.0GHz	2.4GHz
LQP02TN3N5□02	13	14	20	22	23
LQP02TN3N6□02	13	14	21	22	24
LQP02TN3N7□02	13	14	21	22	23
LQP02TN3N8□02	13	14	20	21	23
LQP02TN3N9□02	13	14	20	22	23
LQP02TN4N0□02	13	14	20	21	23
LQP02TN4N1□02	13	14	20	21	23
LQP02TN4N2□02	14	14	20	22	23
LQP02TN4N3□02	13	14	21	22	24
LQP02TN4N7□02	13	14	20	21	23
LQP02TN5N1□02	14	15	21	22	24
LQP02TN5N6□02	14	14	20	22	23
LQP02TN6N2□02	13	14	20	21	22
LQP02TN6N8□02	13	14	20	21	22
LQP02TN7N5□02	14	15	21	22	23
LQP02TN8N2□02	13	14	20	20	22
LQP02TN9N1□02	13	14	18	19	19
LQP02TN10N□02	14	14	19	20	20
LQP02TN11N□02	14	14	18	18	17
LQP02TN12N□02	14	15	18	18	18
LQP02TN13N□02	14	15	19	19	18
LQP02TN15N□02	15	15	18	18	16
LQP02TN16N□02	13	13	15	14	12
LQP02TN18N□02	12	13	14	13	11
LQP02TN20N□02	10	11	11	10	7
LQP02TN22N□02	10	10	10	9	7
LQP02TN24N□02	10	10	10	9	6
LQP02TN27N□02	10	10	8	7	3
LQP02TN30N□02	9	9	7	6	-
LQP02TN33N□02	10	10	7	5	-
LQP02TN36N□02	8	9	6	4	-
LQP02TN39N□02	8	9	4	2	-

⚠Note • Please read rating and ⚠CAUTION (for storage, operating, rating, soldering, mounting and handling) in this catalog to prevent smoking and/or burning, etc.
 • This catalog has only typical specifications. Therefore, please approve our product specifications or transact the approval sheet for product specifications before ordering.

LQP02TQ_02 Series 01005/0402 (inch/mm)

Size Code 01005 (0402) in inch (in mm), Largest Q

■ Appearance/Dimensions

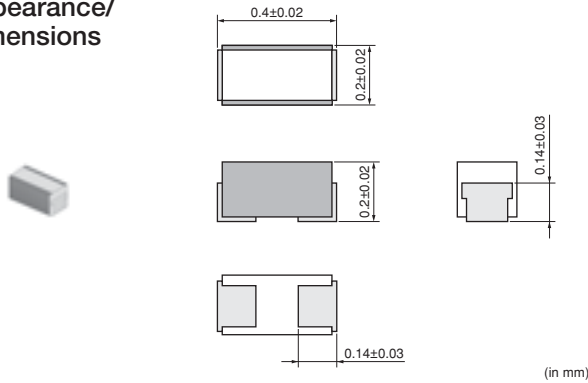

■ Packaging

Code	Packaging	Minimum Quantity
D	ø180mm Paper Taping	20000
B	Packing in Bulk	500



Refer to pages 227 to 230 for mounting information.

■ Rated Value (□: packaging code)

Part Number	Inductance	Inductance Test Frequency	Rated Current	Max. of DC Resistance	Q (min.)	Q Test Frequency	Self-Resonance Frequency (min.)	
LQP02TQ0N4B02□	0.4nH ±0.1nH	500MHz	990mA	0.1Ω	10	500MHz	16600MHz	New
LQP02TQ0N4C02□	0.4nH ±0.2nH	500MHz	990mA	0.1Ω	10	500MHz	16600MHz	New
LQP02TQ0N5B02□	0.5nH ±0.1nH	500MHz	730mA	0.1Ω	10	500MHz	16600MHz	New
LQP02TQ0N5C02□	0.5nH ±0.2nH	500MHz	730mA	0.1Ω	10	500MHz	16600MHz	New
LQP02TQ0N6B02□	0.6nH ±0.1nH	500MHz	730mA	0.1Ω	10	500MHz	16600MHz	New
LQP02TQ0N6C02□	0.6nH ±0.2nH	500MHz	730mA	0.1Ω	10	500MHz	16600MHz	New
LQP02TQ0N7B02□	0.7nH ±0.1nH	500MHz	630mA	0.15Ω	10	500MHz	16600MHz	New
LQP02TQ0N7C02□	0.7nH ±0.2nH	500MHz	630mA	0.15Ω	10	500MHz	16600MHz	New
LQP02TQ0N8B02□	0.8nH ±0.1nH	500MHz	630mA	0.15Ω	10	500MHz	16600MHz	New
LQP02TQ0N8C02□	0.8nH ±0.2nH	500MHz	630mA	0.15Ω	10	500MHz	16600MHz	New
LQP02TQ0N9B02□	0.9nH ±0.1nH	500MHz	580mA	0.15Ω	10	500MHz	16600MHz	New
LQP02TQ0N9C02□	0.9nH ±0.2nH	500MHz	580mA	0.15Ω	10	500MHz	16600MHz	New
LQP02TQ1N0B02□	1.0nH ±0.1nH	500MHz	580mA	0.15Ω	10	500MHz	16600MHz	New
LQP02TQ1N0C02□	1.0nH ±0.2nH	500MHz	580mA	0.15Ω	10	500MHz	16600MHz	New
LQP02TQ1N1B02□	1.1nH ±0.1nH	500MHz	570mA	0.2Ω	10	500MHz	16600MHz	New
LQP02TQ1N1C02□	1.1nH ±0.2nH	500MHz	570mA	0.2Ω	10	500MHz	16600MHz	New
LQP02TQ1N2B02□	1.2nH ±0.1nH	500MHz	550mA	0.2Ω	10	500MHz	16600MHz	New
LQP02TQ1N2C02□	1.2nH ±0.2nH	500MHz	550mA	0.2Ω	10	500MHz	16600MHz	New
LQP02TQ1N3B02□	1.3nH ±0.1nH	500MHz	400mA	0.2Ω	10	500MHz	15000MHz	New
LQP02TQ1N3C02□	1.3nH ±0.2nH	500MHz	400mA	0.2Ω	10	500MHz	15000MHz	New
LQP02TQ1N5B02□	1.5nH ±0.1nH	500MHz	400mA	0.2Ω	10	500MHz	15000MHz	New
LQP02TQ1N5C02□	1.5nH ±0.2nH	500MHz	400mA	0.2Ω	10	500MHz	15000MHz	New
LQP02TQ1N6B02□	1.6nH ±0.1nH	500MHz	390mA	0.3Ω	10	500MHz	15000MHz	New
LQP02TQ1N6C02□	1.6nH ±0.2nH	500MHz	390mA	0.3Ω	10	500MHz	15000MHz	New
LQP02TQ1N8B02□	1.8nH ±0.1nH	500MHz	380mA	0.3Ω	10	500MHz	15000MHz	New
LQP02TQ1N8C02□	1.8nH ±0.2nH	500MHz	380mA	0.3Ω	10	500MHz	15000MHz	New
LQP02TQ2N0B02□	2.0nH ±0.1nH	500MHz	380mA	0.3Ω	10	500MHz	13000MHz	New
LQP02TQ2N0C02□	2.0nH ±0.2nH	500MHz	380mA	0.3Ω	10	500MHz	13000MHz	New
LQP02TQ2N2B02□	2.2nH ±0.1nH	500MHz	380mA	0.3Ω	10	500MHz	13000MHz	New
LQP02TQ2N2C02□	2.2nH ±0.2nH	500MHz	380mA	0.3Ω	10	500MHz	13000MHz	New
LQP02TQ2N4B02□	2.4nH ±0.1nH	500MHz	370mA	0.4Ω	10	500MHz	13000MHz	New
LQP02TQ2N4C02□	2.4nH ±0.2nH	500MHz	370mA	0.4Ω	10	500MHz	13000MHz	New

Operating Temperature Range (Self-temperature rise is not included): -55°C~+125°C
For reflow soldering only.

Continued on the following page.

△Note • Please read rating and △CAUTION (for storage, operating, rating, soldering, mounting and handling) in this catalog to prevent smoking and/or burning, etc.
• This catalog has only typical specifications. Therefore, please approve our product specifications or transact the approval sheet for product specifications before ordering.

Part Number	Inductance	Inductance Test Frequency	Rated Current	Max. of DC Resistance	Q (min.)	Q Test Frequency	Self-Resonance Frequency (min.)	
LQP02TQ2N7B02□	2.7nH ±0.1nH	500MHz	370mA	0.4Ω	10	500MHz	11500MHz	New
LQP02TQ2N7C02□	2.7nH ±0.2nH	500MHz	370mA	0.4Ω	10	500MHz	11500MHz	New
LQP02TQ3N0B02□	3.0nH ±0.1nH	500MHz	360mA	0.45Ω	10	500MHz	10000MHz	New
LQP02TQ3N0C02□	3.0nH ±0.2nH	500MHz	360mA	0.45Ω	10	500MHz	10000MHz	New
LQP02TQ3N3B02□	3.3nH ±0.1nH	500MHz	290mA	0.9Ω	10	500MHz	10000MHz	New
LQP02TQ3N3C02□	3.3nH ±0.2nH	500MHz	290mA	0.9Ω	10	500MHz	10000MHz	New
LQP02TQ3N6B02□	3.6nH ±0.1nH	500MHz	280mA	1Ω	10	500MHz	9700MHz	New
LQP02TQ3N6C02□	3.6nH ±0.2nH	500MHz	280mA	1Ω	10	500MHz	9700MHz	New
LQP02TQ3N9B02□	3.9nH ±0.1nH	500MHz	270mA	1Ω	10	500MHz	9000MHz	New
LQP02TQ3N9C02□	3.9nH ±0.2nH	500MHz	270mA	1Ω	10	500MHz	9000MHz	New
LQP02TQ4N3H02□	4.3nH ±3%	500MHz	270mA	1Ω	10	500MHz	9000MHz	New
LQP02TQ4N3J02□	4.3nH ±5%	500MHz	270mA	1Ω	10	500MHz	9000MHz	New
LQP02TQ4N7H02□	4.7nH ±3%	500MHz	270mA	1Ω	10	500MHz	8500MHz	New
LQP02TQ4N7J02□	4.7nH ±5%	500MHz	270mA	1Ω	10	500MHz	8500MHz	New
LQP02TQ5N1H02□	5.1nH ±3%	500MHz	250mA	1.2Ω	10	500MHz	7800MHz	New
LQP02TQ5N1J02□	5.1nH ±5%	500MHz	250mA	1.2Ω	10	500MHz	7800MHz	New
LQP02TQ5N6H02□	5.6nH ±3%	500MHz	230mA	1.3Ω	10	500MHz	7800MHz	New
LQP02TQ5N6J02□	5.6nH ±5%	500MHz	230mA	1.3Ω	10	500MHz	7800MHz	New
LQP02TQ6N2H02□	6.2nH ±3%	500MHz	220mA	1.3Ω	10	500MHz	7200MHz	New
LQP02TQ6N2J02□	6.2nH ±5%	500MHz	220mA	1.3Ω	10	500MHz	7200MHz	New
LQP02TQ6N8H02□	6.8nH ±3%	500MHz	210mA	1.4Ω	10	500MHz	6600MHz	New
LQP02TQ6N8J02□	6.8nH ±5%	500MHz	210mA	1.4Ω	10	500MHz	6600MHz	New
LQP02TQ7N5H02□	7.5nH ±3%	500MHz	200mA	1.5Ω	10	500MHz	6600MHz	New
LQP02TQ7N5J02□	7.5nH ±5%	500MHz	200mA	1.5Ω	10	500MHz	6600MHz	New
LQP02TQ8N2H02□	8.2nH ±3%	500MHz	190mA	1.6Ω	10	500MHz	6600MHz	New
LQP02TQ8N2J02□	8.2nH ±5%	500MHz	190mA	1.6Ω	10	500MHz	6600MHz	New
LQP02TQ9N1H02□	9.1nH ±3%	500MHz	170mA	1.7Ω	10	500MHz	5900MHz	New
LQP02TQ9N1J02□	9.1nH ±5%	500MHz	170mA	1.7Ω	10	500MHz	5900MHz	New
LQP02TQ10NH02□	10nH ±3%	500MHz	170mA	1.7Ω	10	500MHz	5500MHz	New
LQP02TQ10NJ02□	10nH ±5%	500MHz	170mA	1.7Ω	10	500MHz	5500MHz	New

Operating Temperature Range (Self-temperature rise is not included): -55°C~+125°C
For reflow soldering only.

■ Q-Frequency Characteristics (Typ.)

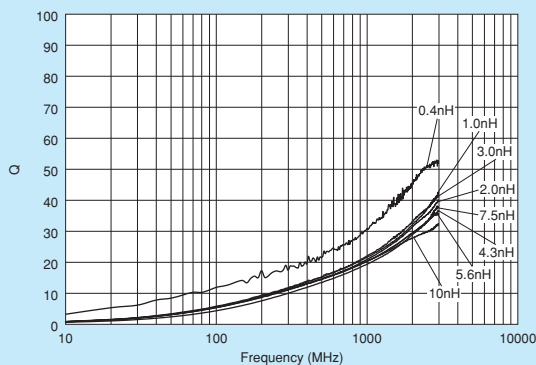

■ Inductance-Frequency Characteristics (Typ.)

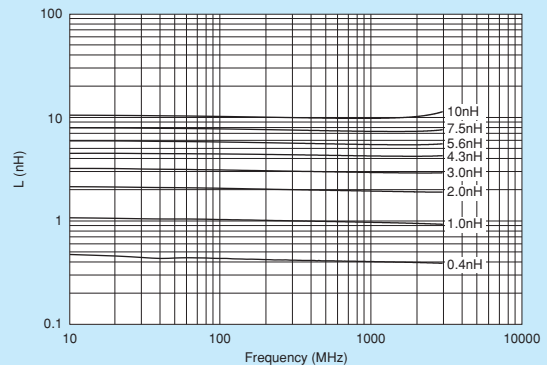

Continued on the following page.

△Note • Please read rating and △CAUTION (for storage, operating, rating, soldering, mounting and handling) in this catalog to prevent smoking and/or burning, etc.
• This catalog has only typical specifications. Therefore, please approve our product specifications or transact the approval sheet for product specifications before ordering.

■ Reference Data

4991A+16196D

Part Number	Q (Typ.)				
	800MHz	900MHz	1.8GHz	2.0GHz	2.4GHz
LQP02TQ0N4	27	28	43	45	50
LQP02TQ0N5	18	20	32	34	39
LQP02TQ0N6	19	21	36	38	43
LQP02TQ0N7	19	21	35	37	42
LQP02TQ0N8	20	21	32	34	38
LQP02TQ0N9	19	20	33	34	38
LQP02TQ1N0	19	20	31	32	37
LQP02TQ1N1	19	21	31	32	36
LQP02TQ1N2	20	21	31	32	37
LQP02TQ1N3	18	19	29	30	34
LQP02TQ1N5	18	19	29	30	34
LQP02TQ1N6	18	19	29	31	36
LQP02TQ1N8	18	20	29	30	35
LQP02TQ2N0	18	20	29	31	34
LQP02TQ2N2	20	21	31	33	38
LQP02TQ2N4	20	21	31	33	38
LQP02TQ2N7	19	20	30	32	37
LQP02TQ3N0	19	20	30	32	36
LQP02TQ3N3	17	18	27	29	33
LQP02TQ3N6	17	18	27	29	32
LQP02TQ3N9	17	18	26	28	31
LQP02TQ4N3	17	18	27	29	32
LQP02TQ4N7	18	19	28	29	32
LQP02TQ5N1	18	19	27	29	32
LQP02TQ5N6	18	19	28	29	32
LQP02TQ6N2	18	19	27	29	31
LQP02TQ6N8	18	19	27	28	30
LQP02TQ7N5	18	19	28	29	32
LQP02TQ8N2	19	20	28	30	32
LQP02TQ9N1	18	19	27	28	30
LQP02TQ10N	18	19	27	28	29

Inductors for Power Lines

Inductors for General Use

Film Type (Non-Magnetic Core)
RF Inductors

△Note • Please read rating and △CAUTION (for storage, operating, rating, soldering, mounting and handling) in this catalog to prevent smoking and/or burning, etc.
• This catalog has only typical specifications. Therefore, please approve our product specifications or transact the approval sheet for product specifications before ordering.

Film Type (Non-Magnetic Core)

LQP03TG_02 Series 0201/0603 (inch/mm)

Size Code 0201 (0603) in inch (in mm), Standard Type

■ Appearance/Dimensions

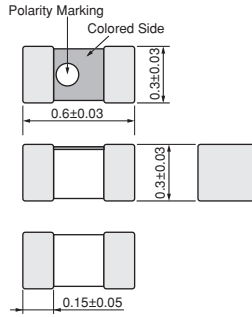

(in mm)

■ Packaging

Code	Packaging	Minimum Quantity
D	ø180mm Paper Taping	15000
J	ø330mm Paper Taping	50000
B	Packing in Bulk	500



Refer to pages 227 to 230 for mounting information.

■ Rated Value (□: packaging code)

Part Number	Inductance	Inductance Test Frequency	Rated Current	Max. of DC Resistance	Q (min.)	Q Test Frequency	Self-Resonance Frequency (min.)	
LQP03TG0N6B02□	0.6nH ±0.1nH	500MHz	850mA	0.08Ω	11	500MHz	18000MHz	Kit
LQP03TG0N6C02□	0.6nH ±0.2nH	500MHz	850mA	0.08Ω	11	500MHz	18000MHz	
LQP03TG0N7B02□	0.7nH ±0.1nH	500MHz	750mA	0.10Ω	12	500MHz	18000MHz	Kit
LQP03TG0N7C02□	0.7nH ±0.2nH	500MHz	750mA	0.10Ω	12	500MHz	18000MHz	
LQP03TG0N8B02□	0.8nH ±0.1nH	500MHz	750mA	0.10Ω	12	500MHz	18000MHz	Kit
LQP03TG0N8C02□	0.8nH ±0.2nH	500MHz	750mA	0.10Ω	12	500MHz	18000MHz	
LQP03TG0N9B02□	0.9nH ±0.1nH	500MHz	700mA	0.12Ω	12	500MHz	18000MHz	Kit
LQP03TG0N9C02□	0.9nH ±0.2nH	500MHz	700mA	0.12Ω	12	500MHz	18000MHz	
LQP03TG1N0B02□	1.0nH ±0.1nH	500MHz	600mA	0.15Ω	12	500MHz	17000MHz	Kit
LQP03TG1N0C02□	1.0nH ±0.2nH	500MHz	600mA	0.15Ω	12	500MHz	17000MHz	
LQP03TG1N1B02□	1.1nH ±0.1nH	500MHz	600mA	0.15Ω	12	500MHz	17000MHz	Kit
LQP03TG1N1C02□	1.1nH ±0.2nH	500MHz	600mA	0.15Ω	12	500MHz	17000MHz	
LQP03TG1N2B02□	1.2nH ±0.1nH	500MHz	600mA	0.15Ω	13	500MHz	15000MHz	Kit
LQP03TG1N2C02□	1.2nH ±0.2nH	500MHz	600mA	0.15Ω	13	500MHz	15000MHz	
LQP03TG1N3B02□	1.3nH ±0.1nH	500MHz	600mA	0.15Ω	13	500MHz	15000MHz	Kit
LQP03TG1N3C02□	1.3nH ±0.2nH	500MHz	600mA	0.15Ω	13	500MHz	15000MHz	
LQP03TG1N4B02□	1.4nH ±0.1nH	500MHz	600mA	0.15Ω	13	500MHz	14000MHz	Kit
LQP03TG1N4C02□	1.4nH ±0.2nH	500MHz	600mA	0.15Ω	13	500MHz	14000MHz	
LQP03TG1N5B02□	1.5nH ±0.1nH	500MHz	600mA	0.15Ω	13	500MHz	13500MHz	Kit
LQP03TG1N5C02□	1.5nH ±0.2nH	500MHz	600mA	0.15Ω	13	500MHz	13500MHz	
LQP03TG1N6B02□	1.6nH ±0.1nH	500MHz	600mA	0.15Ω	13	500MHz	13000MHz	Kit
LQP03TG1N6C02□	1.6nH ±0.2nH	500MHz	600mA	0.15Ω	13	500MHz	13000MHz	
LQP03TG1N7B02□	1.7nH ±0.1nH	500MHz	500mA	0.20Ω	13	500MHz	12500MHz	Kit
LQP03TG1N7C02□	1.7nH ±0.2nH	500MHz	500mA	0.20Ω	13	500MHz	12500MHz	
LQP03TG1N8B02□	1.8nH ±0.1nH	500MHz	500mA	0.20Ω	13	500MHz	12500MHz	Kit
LQP03TG1N8C02□	1.8nH ±0.2nH	500MHz	500mA	0.20Ω	13	500MHz	12500MHz	
LQP03TG1N9B02□	1.9nH ±0.1nH	500MHz	450mA	0.25Ω	13	500MHz	12500MHz	Kit
LQP03TG1N9C02□	1.9nH ±0.2nH	500MHz	450mA	0.25Ω	13	500MHz	12500MHz	
LQP03TG2N0B02□	2.0nH ±0.1nH	500MHz	450mA	0.25Ω	13	500MHz	12500MHz	Kit
LQP03TG2N0C02□	2.0nH ±0.2nH	500MHz	450mA	0.25Ω	13	500MHz	12500MHz	
LQP03TG2N1B02□	2.1nH ±0.1nH	500MHz	450mA	0.25Ω	13	500MHz	12000MHz	Kit
LQP03TG2N1C02□	2.1nH ±0.2nH	500MHz	450mA	0.25Ω	13	500MHz	12000MHz	

Operating Temperature Range (Self-temperature rise is not included): -55°C~+125°C
For reflow soldering only.

Continued on the following page.

△Note • Please read rating and △CAUTION (for storage, operating, rating, soldering, mounting and handling) in this catalog to prevent smoking and/or burning, etc.
• This catalog has only typical specifications. Therefore, please approve our product specifications or transact the approval sheet for product specifications before ordering.

Part Number	Inductance	Inductance Test Frequency	Rated Current	Max. of DC Resistance	Q (min.)	Q Test Frequency	Self-Resonance Frequency (min.)	
LQP03TG2N2B02□	2.2nH ±0.1nH	500MHz	450mA	0.25Ω	13	500MHz	12000MHz	Kit
LQP03TG2N2C02□	2.2nH ±0.2nH	500MHz	450mA	0.25Ω	13	500MHz	12000MHz	
LQP03TG2N3B02□	2.3nH ±0.1nH	500MHz	450mA	0.25Ω	13	500MHz	11500MHz	Kit
LQP03TG2N3C02□	2.3nH ±0.2nH	500MHz	450mA	0.25Ω	13	500MHz	11500MHz	
LQP03TG2N4B02□	2.4nH ±0.1nH	500MHz	450mA	0.25Ω	13	500MHz	11000MHz	Kit
LQP03TG2N4C02□	2.4nH ±0.2nH	500MHz	450mA	0.25Ω	13	500MHz	11000MHz	
LQP03TG2N5B02□	2.5nH ±0.1nH	500MHz	450mA	0.25Ω	13	500MHz	11000MHz	Kit
LQP03TG2N5C02□	2.5nH ±0.2nH	500MHz	450mA	0.25Ω	13	500MHz	11000MHz	
LQP03TG2N6B02□	2.6nH ±0.1nH	500MHz	450mA	0.25Ω	13	500MHz	11000MHz	Kit
LQP03TG2N6C02□	2.6nH ±0.2nH	500MHz	450mA	0.25Ω	13	500MHz	11000MHz	
LQP03TG2N7B02□	2.7nH ±0.1nH	500MHz	450mA	0.25Ω	13	500MHz	11000MHz	Kit
LQP03TG2N7C02□	2.7nH ±0.2nH	500MHz	450mA	0.25Ω	13	500MHz	11000MHz	
LQP03TG2N8B02□	2.8nH ±0.1nH	500MHz	450mA	0.25Ω	13	500MHz	9500MHz	Kit
LQP03TG2N8C02□	2.8nH ±0.2nH	500MHz	450mA	0.25Ω	13	500MHz	9500MHz	
LQP03TG2N9B02□	2.9nH ±0.1nH	500MHz	450mA	0.25Ω	13	500MHz	9500MHz	Kit
LQP03TG2N9C02□	2.9nH ±0.2nH	500MHz	450mA	0.25Ω	13	500MHz	9500MHz	
LQP03TG3N0B02□	3.0nH ±0.1nH	500MHz	450mA	0.25Ω	13	500MHz	9500MHz	Kit
LQP03TG3N0C02□	3.0nH ±0.2nH	500MHz	450mA	0.25Ω	13	500MHz	9500MHz	
LQP03TG3N1B02□	3.1nH ±0.1nH	500MHz	400mA	0.32Ω	13	500MHz	9500MHz	Kit
LQP03TG3N1C02□	3.1nH ±0.2nH	500MHz	400mA	0.32Ω	13	500MHz	9500MHz	
LQP03TG3N2B02□	3.2nH ±0.1nH	500MHz	400mA	0.32Ω	13	500MHz	9500MHz	Kit
LQP03TG3N2C02□	3.2nH ±0.2nH	500MHz	400mA	0.32Ω	13	500MHz	9500MHz	
LQP03TG3N3B02□	3.3nH ±0.1nH	500MHz	400mA	0.32Ω	13	500MHz	9500MHz	Kit
LQP03TG3N3C02□	3.3nH ±0.2nH	500MHz	400mA	0.32Ω	13	500MHz	9500MHz	
LQP03TG3N4B02□	3.4nH ±0.1nH	500MHz	350mA	0.35Ω	13	500MHz	8000MHz	Kit
LQP03TG3N4C02□	3.4nH ±0.2nH	500MHz	350mA	0.35Ω	13	500MHz	8000MHz	
LQP03TG3N5B02□	3.5nH ±0.1nH	500MHz	350mA	0.35Ω	13	500MHz	8000MHz	Kit
LQP03TG3N5C02□	3.5nH ±0.2nH	500MHz	350mA	0.35Ω	13	500MHz	8000MHz	
LQP03TG3N6B02□	3.6nH ±0.1nH	500MHz	350mA	0.35Ω	13	500MHz	8000MHz	Kit
LQP03TG3N6C02□	3.6nH ±0.2nH	500MHz	350mA	0.35Ω	13	500MHz	8000MHz	
LQP03TG3N7B02□	3.7nH ±0.1nH	500MHz	350mA	0.35Ω	13	500MHz	7000MHz	Kit
LQP03TG3N7C02□	3.7nH ±0.2nH	500MHz	350mA	0.35Ω	13	500MHz	7000MHz	
LQP03TG3N8B02□	3.8nH ±0.1nH	500MHz	350mA	0.35Ω	13	500MHz	7000MHz	Kit
LQP03TG3N8C02□	3.8nH ±0.2nH	500MHz	350mA	0.35Ω	13	500MHz	7000MHz	
LQP03TG3N9B02□	3.9nH ±0.1nH	500MHz	350mA	0.35Ω	13	500MHz	6500MHz	Kit
LQP03TG3N9C02□	3.9nH ±0.2nH	500MHz	350mA	0.35Ω	13	500MHz	6500MHz	
LQP03TG4N3H02□	4.3nH ±3%	500MHz	300mA	0.58Ω	13	500MHz	6500MHz	Kit
LQP03TG4N3J02□	4.3nH ±5%	500MHz	300mA	0.58Ω	13	500MHz	6500MHz	
LQP03TG4N7H02□	4.7nH ±3%	500MHz	250mA	0.72Ω	12	500MHz	6500MHz	Kit
LQP03TG4N7J02□	4.7nH ±5%	500MHz	250mA	0.72Ω	12	500MHz	6500MHz	
LQP03TG5N1H02□	5.1nH ±3%	500MHz	250mA	0.72Ω	12	500MHz	6500MHz	Kit
LQP03TG5N1J02□	5.1nH ±5%	500MHz	250mA	0.72Ω	12	500MHz	6500MHz	
LQP03TG5N6H02□	5.6nH ±3%	500MHz	250mA	0.88Ω	12	500MHz	6000MHz	Kit
LQP03TG5N6J02□	5.6nH ±5%	500MHz	250mA	0.88Ω	12	500MHz	6000MHz	
LQP03TG6N2H02□	6.2nH ±3%	500MHz	200mA	1.15Ω	12	500MHz	6000MHz	Kit
LQP03TG6N2J02□	6.2nH ±5%	500MHz	200mA	1.15Ω	12	500MHz	6000MHz	
LQP03TG6N8H02□	6.8nH ±3%	500MHz	200mA	1.15Ω	12	500MHz	5400MHz	Kit

Operating Temperature Range (Self-temperature rise is not included): -55°C~+125°C
For reflow soldering only.

Continued on the following page. 

△Note • Please read rating and △CAUTION (for storage, operating, rating, soldering, mounting and handling) in this catalog to prevent smoking and/or burning, etc.
• This catalog has only typical specifications. Therefore, please approve our product specifications or transact the approval sheet for product specifications before ordering.

Part Number	Inductance	Inductance Test Frequency	Rated Current	Max. of DC Resistance	Q (min.)	Q Test Frequency	Self-Resonance Frequency (min.)	
LQP03TG6N8J02□	6.8nH ±5%	500MHz	200mA	1.15Ω	12	500MHz	5400MHz	
LQP03TG7N5H02□	7.5nH ±3%	500MHz	200mA	1.22Ω	12	500MHz	4800MHz	Kit
LQP03TG7N5J02□	7.5nH ±5%	500MHz	200mA	1.22Ω	12	500MHz	4800MHz	
LQP03TG8N2H02□	8.2nH ±3%	500MHz	200mA	1.40Ω	12	500MHz	4800MHz	Kit
LQP03TG8N2J02□	8.2nH ±5%	500MHz	200mA	1.40Ω	12	500MHz	4800MHz	
LQP03TG9N1H02□	9.1nH ±3%	500MHz	200mA	1.40Ω	11	500MHz	4500MHz	Kit
LQP03TG9N1J02□	9.1nH ±5%	500MHz	200mA	1.40Ω	11	500MHz	4500MHz	
LQP03TG10NH02□	10nH ±3%	500MHz	190mA	1.52Ω	11	500MHz	4500MHz	Kit
LQP03TG10NJ02□	10nH ±5%	500MHz	190mA	1.52Ω	11	500MHz	4500MHz	
LQP03TG12NH02□	12nH ±3%	500MHz	180mA	1.78Ω	11	500MHz	3700MHz	Kit
LQP03TG12NJ02□	12nH ±5%	500MHz	180mA	1.78Ω	11	500MHz	3700MHz	
LQP03TG15NH02□	15nH ±3%	500MHz	170mA	1.90Ω	11	500MHz	3100MHz	Kit
LQP03TG15NJ02□	15nH ±5%	500MHz	170mA	1.90Ω	11	500MHz	3100MHz	
LQP03TG18NH02□	18nH ±3%	500MHz	160mA	2.28Ω	11	500MHz	2800MHz	Kit
LQP03TG18NJ02□	18nH ±5%	500MHz	160mA	2.28Ω	11	500MHz	2800MHz	
LQP03TG22NH02□	22nH ±3%	500MHz	140mA	2.85Ω	9	500MHz	2500MHz	Kit
LQP03TG22NJ02□	22nH ±5%	500MHz	140mA	2.85Ω	9	500MHz	2500MHz	
LQP03TG27NH02□	27nH ±3%	500MHz	120mA	3.65Ω	7	500MHz	1700MHz	New
LQP03TG27NJ02□	27nH ±5%	500MHz	120mA	3.65Ω	7	500MHz	1700MHz	New
LQP03TG33NJ02□	33nH ±5%	300MHz	110mA	4.25Ω	7	300MHz	1600MHz	New
LQP03TG39NJ02□	39nH ±5%	300MHz	110mA	4.6Ω	7	300MHz	1500MHz	New
LQP03TG47NJ02□	47nH ±5%	300MHz	100mA	5.2Ω	7	300MHz	1300MHz	New
LQP03TG56NJ02□	56nH ±5%	300MHz	100mA	5.6Ω	7	300MHz	1200MHz	New
LQP03TG68NJ02□	68nH ±5%	300MHz	90mA	6.25Ω	6	300MHz	1100MHz	New
LQP03TG82NJ02□	82nH ±5%	300MHz	90mA	7.15Ω	6	300MHz	1000MHz	New
LQP03TGR10J02□	100nH ±5%	300MHz	80mA	8.05Ω	6	300MHz	900MHz	New
LQP03TGR12J02□	120nH ±5%	300MHz	80mA	8.75Ω	6	300MHz	800MHz	New

Operating Temperature Range (Self-temperature rise is not included): -55°C~+125°C
For reflow soldering only.

■ Q-Frequency Characteristics (Typ.)

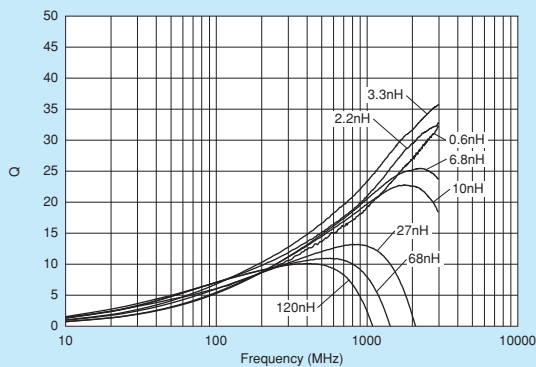

■ Inductance-Frequency Characteristics (Typ.)

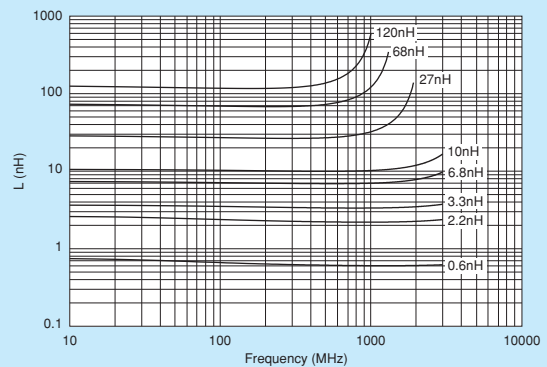

Continued on the following page.

△Note • Please read rating and △CAUTION (for storage, operating, rating, soldering, mounting and handling) in this catalog to prevent smoking and/or burning, etc.
• This catalog has only typical specifications. Therefore, please approve our product specifications or transact the approval sheet for product specifications before ordering.

Reference Data

4991A+16197A

Part Number	Q (Typ.)				
	800MHz	900MHz	1.8GHz	2.0GHz	2.4GHz
LQP03TG0N6	17	18	26	27	29
LQP03TG0N7	18	20	29	30	33
LQP03TG0N8	18	20	29	30	33
LQP03TG0N9	19	20	30	31	34
LQP03TG1N0	18	19	28	29	31
LQP03TG1N1	18	20	28	29	32
LQP03TG1N2	19	20	29	30	33
LQP03TG1N3	18	19	28	29	32
LQP03TG1N4	20	21	31	32	34
LQP03TG1N5	21	22	32	33	35
LQP03TG1N6	18	20	29	30	32
LQP03TG1N7	19	20	29	30	33
LQP03TG1N8	20	21	30	31	33
LQP03TG1N9	19	20	29	31	33
LQP03TG2N0	20	21	30	31	33
LQP03TG2N1	19	20	28	29	31
LQP03TG2N2	19	20	28	29	31
LQP03TG2N3	19	20	28	29	32
LQP03TG2N4	20	21	30	31	34
LQP03TG2N5	19	20	29	30	32
LQP03TG2N6	19	20	28	30	32
LQP03TG2N7	19	20	29	30	31
LQP03TG2N8	20	21	30	31	33
LQP03TG2N9	20	21	30	31	34
LQP03TG3N0	21	22	30	31	33
LQP03TG3N1	20	21	30	31	34
LQP03TG3N2	20	21	30	31	33
LQP03TG3N3	21	22	31	31	34
LQP03TG3N4	20	21	29	30	32
LQP03TG3N5	19	20	28	29	31
LQP03TG3N6	20	21	29	29	31
LQP03TG3N7	18	20	28	29	30
LQP03TG3N8	18	19	27	28	30
LQP03TG3N9	20	21	29	30	31
LQP03TG4N3	19	21	28	28	30
LQP03TG4N7	19	20	27	28	29
LQP03TG5N1	19	20	27	27	29
LQP03TG5N6	18	19	25	26	27
LQP03TG6N2	18	19	25	26	26
LQP03TG6N8	18	19	25	25	25
LQP03TG7N5	18	19	24	24	24
LQP03TG8N2	18	19	24	24	24
LQP03TG9N1	18	19	23	22	22
LQP03TG10N	18	19	23	23	22
LQP03TG12N	17	18	20	20	17
LQP03TG15N	17	18	18	17	13
LQP03TG18N	15	16	14	13	8
LQP03TG22N	13	14	11	9	4

Continued on the following page. 

△Note • Please read rating and △CAUTION (for storage, operating, rating, soldering, mounting and handling) in this catalog to prevent smoking and/or burning, etc.
 • This catalog has only typical specifications. Therefore, please approve our product specifications or transact the approval sheet for product specifications before ordering.

Part Number	Q (Typ.)				
	800MHz	900MHz	1.8GHz	2.0GHz	2.4GHz
LQP03TG27N	13	13	5	-	-
LQP03TG33N	13	12	-	-	-
LQP03TG39N	13	12	-	-	-
LQP03TG47N	13	12	-	-	-
LQP03TG56N	11	10	-	-	-
LQP03TG68N	10	9	-	-	-
LQP03TG82N	9	8	-	-	-
LQP03TGR10	7	6	-	-	-
LQP03TGR12	7	5	-	-	-

LQP03TN_02 Series 0201/0603 (inch/mm)

Size Code 0201 (0603) in inch (in mm), High Q, Wide Variation

Appearance/Dimensions

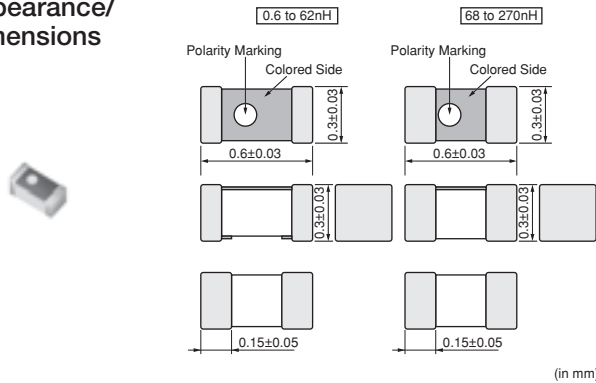

Packaging

Code	Packaging	Minimum Quantity
D	ø180mm Paper Taping	15000
J	ø330mm Paper Taping	50000
B	Packing in Bulk	500



Refer to pages 227 to 230 for mounting information.

Rated Value (□: packaging code)

Part Number	Inductance	Inductance Test Frequency	Rated Current	Max. of DC Resistance	Q (min.)	Q Test Frequency	Self-Resonance Frequency (min.)	
LQP03TN0N6B02□	0.6nH ±0.1nH	500MHz	850mA	0.07Ω	14	500MHz	20000MHz	Kit
LQP03TN0N6C02□	0.6nH ±0.2nH	500MHz	850mA	0.07Ω	14	500MHz	20000MHz	
LQP03TN0N7B02□	0.7nH ±0.1nH	500MHz	800mA	0.08Ω	14	500MHz	20000MHz	Kit
LQP03TN0N7C02□	0.7nH ±0.2nH	500MHz	800mA	0.08Ω	14	500MHz	20000MHz	
LQP03TN0N8B02□	0.8nH ±0.1nH	500MHz	800mA	0.08Ω	14	500MHz	18000MHz	Kit
LQP03TN0N8C02□	0.8nH ±0.2nH	500MHz	800mA	0.08Ω	14	500MHz	18000MHz	
LQP03TN0N9B02□	0.9nH ±0.1nH	500MHz	750mA	0.10Ω	14	500MHz	18000MHz	Kit
LQP03TN0N9C02□	0.9nH ±0.2nH	500MHz	750mA	0.10Ω	14	500MHz	18000MHz	
LQP03TN1N0B02□	1.0nH ±0.1nH	500MHz	750mA	0.10Ω	14	500MHz	17000MHz	Kit
LQP03TN1N0C02□	1.0nH ±0.2nH	500MHz	750mA	0.10Ω	14	500MHz	17000MHz	
LQP03TN1N1B02□	1.1nH ±0.1nH	500MHz	750mA	0.10Ω	14	500MHz	17000MHz	Kit
LQP03TN1N1C02□	1.1nH ±0.2nH	500MHz	750mA	0.10Ω	14	500MHz	17000MHz	
LQP03TN1N2B02□	1.2nH ±0.1nH	500MHz	750mA	0.10Ω	14	500MHz	17000MHz	Kit
LQP03TN1N2C02□	1.2nH ±0.2nH	500MHz	750mA	0.10Ω	14	500MHz	17000MHz	
LQP03TN1N3B02□	1.3nH ±0.1nH	500MHz	600mA	0.15Ω	14	500MHz	17000MHz	Kit
LQP03TN1N3C02□	1.3nH ±0.2nH	500MHz	600mA	0.15Ω	14	500MHz	17000MHz	
LQP03TN1N4B02□	1.4nH ±0.1nH	500MHz	600mA	0.15Ω	14	500MHz	16000MHz	Kit
LQP03TN1N4C02□	1.4nH ±0.2nH	500MHz	600mA	0.15Ω	14	500MHz	16000MHz	
LQP03TN1N5B02□	1.5nH ±0.1nH	500MHz	600mA	0.15Ω	14	500MHz	15000MHz	Kit
LQP03TN1N5C02□	1.5nH ±0.2nH	500MHz	600mA	0.15Ω	14	500MHz	15000MHz	
LQP03TN1N6B02□	1.6nH ±0.1nH	500MHz	600mA	0.15Ω	14	500MHz	15000MHz	Kit
LQP03TN1N6C02□	1.6nH ±0.2nH	500MHz	600mA	0.15Ω	14	500MHz	15000MHz	
LQP03TN1N7B02□	1.7nH ±0.1nH	500MHz	600mA	0.15Ω	14	500MHz	15000MHz	Kit
LQP03TN1N7C02□	1.7nH ±0.2nH	500MHz	600mA	0.15Ω	14	500MHz	15000MHz	
LQP03TN1N8B02□	1.8nH ±0.1nH	500MHz	600mA	0.15Ω	14	500MHz	15000MHz	Kit
LQP03TN1N8C02□	1.8nH ±0.2nH	500MHz	600mA	0.15Ω	14	500MHz	15000MHz	
LQP03TN1N9B02□	1.9nH ±0.1nH	500MHz	600mA	0.15Ω	14	500MHz	12500MHz	Kit
LQP03TN1N9C02□	1.9nH ±0.2nH	500MHz	600mA	0.15Ω	14	500MHz	12500MHz	
LQP03TN2N0B02□	2.0nH ±0.1nH	500MHz	600mA	0.15Ω	14	500MHz	12500MHz	Kit
LQP03TN2N0C02□	2.0nH ±0.2nH	500MHz	600mA	0.15Ω	14	500MHz	12500MHz	
LQP03TN2N1B02□	2.1nH ±0.1nH	500MHz	600mA	0.15Ω	14	500MHz	11000MHz	Kit
LQP03TN2N1C02□	2.1nH ±0.2nH	500MHz	600mA	0.15Ω	14	500MHz	11000MHz	
LQP03TN2N2B02□	2.2nH ±0.1nH	500MHz	600mA	0.15Ω	14	500MHz	11000MHz	Kit

Operating Temperature Range (Self-temperature rise is not included): -55°C~+125°C
For reflow soldering only.

Continued on the following page.

△Note • Please read rating and △CAUTION (for storage, operating, rating, soldering, mounting and handling) in this catalog to prevent smoking and/or burning, etc.
• This catalog has only typical specifications. Therefore, please approve our product specifications or transact the approval sheet for product specifications before ordering.

Part Number	Inductance	Inductance Test Frequency	Rated Current	Max. of DC Resistance	Q (min.)	Q Test Frequency	Self-Resonance Frequency (min.)	
LQP03TN2N2C02□	2.2nH ±0.2nH	500MHz	600mA	0.15Ω	14	500MHz	11000MHz	
LQP03TN2N3B02□	2.3nH ±0.1nH	500MHz	500mA	0.20Ω	14	500MHz	10000MHz	Kit
LQP03TN2N3C02□	2.3nH ±0.2nH	500MHz	500mA	0.20Ω	14	500MHz	10000MHz	
LQP03TN2N4B02□	2.4nH ±0.1nH	500MHz	500mA	0.20Ω	14	500MHz	10000MHz	Kit
LQP03TN2N4C02□	2.4nH ±0.2nH	500MHz	500mA	0.20Ω	14	500MHz	10000MHz	
LQP03TN2N5B02□	2.5nH ±0.1nH	500MHz	500mA	0.20Ω	14	500MHz	10000MHz	Kit
LQP03TN2N5C02□	2.5nH ±0.2nH	500MHz	500mA	0.20Ω	14	500MHz	10000MHz	
LQP03TN2N6B02□	2.6nH ±0.1nH	500MHz	500mA	0.20Ω	14	500MHz	10000MHz	Kit
LQP03TN2N6C02□	2.6nH ±0.2nH	500MHz	500mA	0.20Ω	14	500MHz	10000MHz	
LQP03TN2N7B02□	2.7nH ±0.1nH	500MHz	500mA	0.20Ω	14	500MHz	10000MHz	Kit
LQP03TN2N7C02□	2.7nH ±0.2nH	500MHz	500mA	0.20Ω	14	500MHz	10000MHz	
LQP03TN2N8B02□	2.8nH ±0.1nH	500MHz	500mA	0.20Ω	14	500MHz	9500MHz	Kit
LQP03TN2N8C02□	2.8nH ±0.2nH	500MHz	500mA	0.20Ω	14	500MHz	9500MHz	
LQP03TN2N9B02□	2.9nH ±0.1nH	500MHz	500mA	0.20Ω	14	500MHz	9500MHz	Kit
LQP03TN2N9C02□	2.9nH ±0.2nH	500MHz	500mA	0.20Ω	14	500MHz	9500MHz	
LQP03TN3N0B02□	3.0nH ±0.1nH	500MHz	450mA	0.25Ω	14	500MHz	9500MHz	Kit
LQP03TN3N0C02□	3.0nH ±0.2nH	500MHz	450mA	0.25Ω	14	500MHz	9500MHz	
LQP03TN3N1B02□	3.1nH ±0.1nH	500MHz	450mA	0.25Ω	14	500MHz	8000MHz	Kit
LQP03TN3N1C02□	3.1nH ±0.2nH	500MHz	450mA	0.25Ω	14	500MHz	8000MHz	
LQP03TN3N2B02□	3.2nH ±0.1nH	500MHz	450mA	0.25Ω	14	500MHz	8000MHz	Kit
LQP03TN3N2C02□	3.2nH ±0.2nH	500MHz	450mA	0.25Ω	14	500MHz	8000MHz	
LQP03TN3N3B02□	3.3nH ±0.1nH	500MHz	450mA	0.25Ω	14	500MHz	8000MHz	Kit
LQP03TN3N3C02□	3.3nH ±0.2nH	500MHz	450mA	0.25Ω	14	500MHz	8000MHz	
LQP03TN3N4B02□	3.4nH ±0.1nH	500MHz	450mA	0.25Ω	14	500MHz	7000MHz	Kit
LQP03TN3N4C02□	3.4nH ±0.2nH	500MHz	450mA	0.25Ω	14	500MHz	7000MHz	
LQP03TN3N5B02□	3.5nH ±0.1nH	500MHz	450mA	0.25Ω	14	500MHz	7000MHz	Kit
LQP03TN3N5C02□	3.5nH ±0.2nH	500MHz	450mA	0.25Ω	14	500MHz	7000MHz	
LQP03TN3N6B02□	3.6nH ±0.1nH	500MHz	400mA	0.30Ω	14	500MHz	6000MHz	Kit
LQP03TN3N6C02□	3.6nH ±0.2nH	500MHz	400mA	0.30Ω	14	500MHz	6000MHz	
LQP03TN3N7B02□	3.7nH ±0.1nH	500MHz	400mA	0.30Ω	14	500MHz	6000MHz	Kit
LQP03TN3N7C02□	3.7nH ±0.2nH	500MHz	400mA	0.30Ω	14	500MHz	6000MHz	
LQP03TN3N8B02□	3.8nH ±0.1nH	500MHz	400mA	0.30Ω	14	500MHz	6000MHz	Kit
LQP03TN3N8C02□	3.8nH ±0.2nH	500MHz	400mA	0.30Ω	14	500MHz	6000MHz	
LQP03TN3N9B02□	3.9nH ±0.1nH	500MHz	400mA	0.30Ω	14	500MHz	5700MHz	Kit
LQP03TN3N9C02□	3.9nH ±0.2nH	500MHz	400mA	0.30Ω	14	500MHz	5700MHz	
LQP03TN4N0B02□	4.0nH ±0.1nH	500MHz	350mA	0.40Ω	14	500MHz	5300MHz	Kit
LQP03TN4N0C02□	4.0nH ±0.2nH	500MHz	350mA	0.40Ω	14	500MHz	5300MHz	
LQP03TN4N1B02□	4.1nH ±0.1nH	500MHz	350mA	0.40Ω	14	500MHz	5300MHz	Kit
LQP03TN4N1C02□	4.1nH ±0.2nH	500MHz	350mA	0.40Ω	14	500MHz	5300MHz	
LQP03TN4N2B02□	4.2nH ±0.1nH	500MHz	350mA	0.40Ω	14	500MHz	5300MHz	Kit
LQP03TN4N2C02□	4.2nH ±0.2nH	500MHz	350mA	0.40Ω	14	500MHz	5300MHz	
LQP03TN4N3H02□	4.3nH ±3%	500MHz	350mA	0.40Ω	14	500MHz	5300MHz	Kit
LQP03TN4N3J02□	4.3nH ±5%	500MHz	350mA	0.40Ω	14	500MHz	5300MHz	
LQP03TN4N7H02□	4.7nH ±3%	500MHz	350mA	0.40Ω	14	500MHz	4400MHz	Kit
LQP03TN4N7J02□	4.7nH ±5%	500MHz	350mA	0.40Ω	14	500MHz	4400MHz	
LQP03TN5N1H02□	5.1nH ±3%	500MHz	350mA	0.40Ω	14	500MHz	4200MHz	Kit
LQP03TN5N1J02□	5.1nH ±5%	500MHz	350mA	0.40Ω	14	500MHz	4200MHz	
LQP03TN5N6H02□	5.6nH ±3%	500MHz	350mA	0.40Ω	14	500MHz	4000MHz	Kit

Operating Temperature Range (Self-temperature rise is not included): -55°C~+125°C
For reflow soldering only.

Continued on the following page. 

△Note • Please read rating and △CAUTION (for storage, operating, rating, soldering, mounting and handling) in this catalog to prevent smoking and/or burning, etc.
• This catalog has only typical specifications. Therefore, please approve our product specifications or transact the approval sheet for product specifications before ordering.

Part Number	Inductance	Inductance Test Frequency	Rated Current	Max. of DC Resistance	Q (min.)	Q Test Frequency	Self-Resonance Frequency (min.)	
LQP03TN5N6J02□	5.6nH ±5%	500MHz	350mA	0.40Ω	14	500MHz	4000MHz	
LQP03TN6N2H02□	6.2nH ±3%	500MHz	300mA	0.60Ω	14	500MHz	4000MHz	Kit
LQP03TN6N2J02□	6.2nH ±5%	500MHz	300mA	0.60Ω	14	500MHz	4000MHz	
LQP03TN6N8H02□	6.8nH ±3%	500MHz	300mA	0.60Ω	14	500MHz	3900MHz	Kit
LQP03TN6N8J02□	6.8nH ±5%	500MHz	300mA	0.60Ω	14	500MHz	3900MHz	
LQP03TN7N5H02□	7.5nH ±3%	500MHz	300mA	0.60Ω	14	500MHz	3700MHz	Kit
LQP03TN7N5J02□	7.5nH ±5%	500MHz	300mA	0.60Ω	14	500MHz	3700MHz	
LQP03TN8N2H02□	8.2nH ±3%	500MHz	250mA	0.70Ω	14	500MHz	3600MHz	Kit
LQP03TN8N2J02□	8.2nH ±5%	500MHz	250mA	0.70Ω	14	500MHz	3600MHz	
LQP03TN9N1H02□	9.1nH ±3%	500MHz	250mA	0.70Ω	14	500MHz	3300MHz	Kit
LQP03TN9N1J02□	9.1nH ±5%	500MHz	250mA	0.70Ω	14	500MHz	3300MHz	
LQP03TN10NH02□	10nH ±3%	500MHz	250mA	0.70Ω	14	500MHz	3200MHz	Kit
LQP03TN10NJ02□	10nH ±5%	500MHz	250mA	0.70Ω	14	500MHz	3200MHz	
LQP03TN11NH02□	11nH ±3%	500MHz	250mA	0.80Ω	14	500MHz	2900MHz	Kit
LQP03TN11NJ02□	11nH ±5%	500MHz	250mA	0.80Ω	14	500MHz	2900MHz	
LQP03TN12NH02□	12nH ±3%	500MHz	250mA	0.70Ω	12	500MHz	2900MHz	Kit
LQP03TN12NJ02□	12nH ±5%	500MHz	250mA	0.70Ω	12	500MHz	2900MHz	
LQP03TN13NH02□	13nH ±3%	500MHz	250mA	0.80Ω	12	500MHz	2600MHz	Kit
LQP03TN13NJ02□	13nH ±5%	500MHz	250mA	0.80Ω	12	500MHz	2600MHz	
LQP03TN15NH02□	15nH ±3%	500MHz	250mA	0.70Ω	12	500MHz	2600MHz	Kit
LQP03TN15NJ02□	15nH ±5%	500MHz	250mA	0.70Ω	12	500MHz	2600MHz	
LQP03TN16NH02□	16nH ±3%	500MHz	200mA	0.95Ω	12	500MHz	2200MHz	Kit
LQP03TN16NJ02□	16nH ±5%	500MHz	200mA	0.95Ω	12	500MHz	2200MHz	
LQP03TN18NH02□	18nH ±3%	500MHz	200mA	0.80Ω	12	500MHz	2200MHz	Kit
LQP03TN18NJ02□	18nH ±5%	500MHz	200mA	0.80Ω	12	500MHz	2200MHz	
LQP03TN20NH02□	20nH ±3%	500MHz	150mA	2.30Ω	12	500MHz	2200MHz	Kit
LQP03TN20NJ02□	20nH ±5%	500MHz	150mA	2.30Ω	12	500MHz	2200MHz	
LQP03TN22NH02□	22nH ±3%	500MHz	150mA	1.90Ω	12	500MHz	2200MHz	Kit
LQP03TN22NJ02□	22nH ±5%	500MHz	150mA	1.90Ω	12	500MHz	2200MHz	
LQP03TN24NH02□	24nH ±3%	500MHz	140mA	2.30Ω	12	500MHz	2000MHz	Kit
LQP03TN24NJ02□	24nH ±5%	500MHz	140mA	2.30Ω	12	500MHz	2000MHz	
LQP03TN27NH02□	27nH ±3%	500MHz	140mA	2.30Ω	12	500MHz	2000MHz	Kit
LQP03TN27NJ02□	27nH ±5%	500MHz	140mA	2.30Ω	12	500MHz	2000MHz	
LQP03TN30NH02□	30nH ±3%	500MHz	120mA	2.95Ω	9	500MHz	1700MHz	Kit
LQP03TN30NJ02□	30nH ±5%	500MHz	120mA	2.95Ω	9	500MHz	1700MHz	
LQP03TN33NJ02□	33nH ±5%	300MHz	120mA	2.95Ω	9	300MHz	1700MHz	Kit
LQP03TN36NJ02□	36nH ±5%	300MHz	120mA	3.00Ω	9	300MHz	1500MHz	Kit
LQP03TN39NJ02□	39nH ±5%	300MHz	120mA	3.00Ω	9	300MHz	1500MHz	Kit
LQP03TN43NJ02□	43nH ±5%	300MHz	100mA	3.60Ω	9	300MHz	1300MHz	Kit
LQP03TN47NJ02□	47nH ±5%	300MHz	100mA	3.60Ω	9	300MHz	1300MHz	Kit
LQP03TN51NJ02□	51nH ±5%	300MHz	100mA	3.90Ω	9	300MHz	1200MHz	Kit
LQP03TN56NJ02□	56nH ±5%	300MHz	100mA	3.90Ω	9	300MHz	1200MHz	Kit
LQP03TN62NJ02□	62nH ±5%	300MHz	100mA	8Ω	8	300MHz	1100MHz	Kit
LQP03TN68NJ02□	68nH ±5%	300MHz	100mA	8Ω	8	300MHz	1100MHz	Kit
LQP03TN75NJ02□	75nH ±5%	300MHz	100mA	10Ω	8	300MHz	1000MHz	New
LQP03TN82NJ02□	82nH ±5%	300MHz	100mA	10Ω	8	300MHz	1000MHz	Kit
LQP03TN91NJ02□	91nH ±5%	300MHz	80mA	10Ω	8	300MHz	900MHz	New Kit
LQP03TNR10J02□	100nH ±5%	300MHz	80mA	10Ω	8	300MHz	900MHz	Kit

Operating Temperature Range (Self-temperature rise is not included): -55°C~+125°C
For reflow soldering only.

Continued on the following page. 

△Note • Please read rating and △CAUTION (for storage, operating, rating, soldering, mounting and handling) in this catalog to prevent smoking and/or burning, etc.
• This catalog has only typical specifications. Therefore, please approve our product specifications or transact the approval sheet for product specifications before ordering.

Part Number	Inductance	Inductance Test Frequency	Rated Current	Max. of DC Resistance	Q (min.)	Q Test Frequency	Self-Resonance Frequency (min.)	
LQP03TNR11J02□	110nH ±5%	300MHz	80mA	12Ω	8	300MHz	800MHz	New Kit
LQP03TNR12J02□	120nH ±5%	300MHz	80mA	12Ω	8	300MHz	800MHz	Kit
LQP03TNR13J02□	130nH ±5%	100MHz	80mA	9Ω	5	100MHz	650MHz	New Kit
LQP03TNR15J02□	150nH ±5%	100MHz	80mA	9Ω	5	100MHz	650MHz	Kit
LQP03TNR16J02□	160nH ±5%	100MHz	70mA	11Ω	5	100MHz	600MHz	New Kit
LQP03TNR18J02□	180nH ±5%	100MHz	70mA	11Ω	5	100MHz	600MHz	Kit
LQP03TNR20J02□	200nH ±5%	100MHz	60mA	13Ω	5	100MHz	500MHz	New Kit
LQP03TNR22J02□	220nH ±5%	100MHz	60mA	13Ω	5	100MHz	500MHz	Kit
LQP03TNR24J02□	240nH ±5%	100MHz	60mA	15Ω	5	100MHz	450MHz	New Kit
LQP03TNR27J02□	270nH ±5%	100MHz	60mA	15Ω	5	100MHz	450MHz	Kit

Operating Temperature Range (Self-temperature rise is not included): -55°C~+125°C
For reflow soldering only.

■ Q-Frequency Characteristics (Typ.)

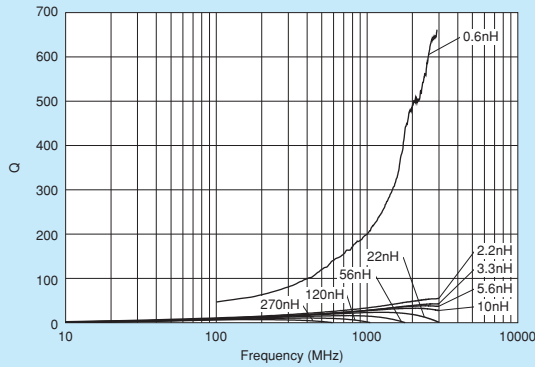

■ Inductance-Frequency Characteristics (Typ.)

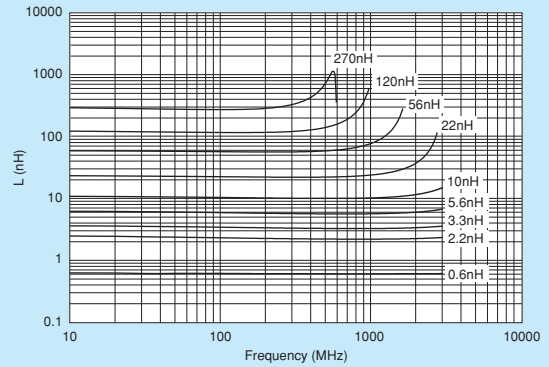

■ Reference Data

4991A&16197A

Part Number	Q (Typ.)				
	800MHz	900MHz	1.8GHz	2.0GHz	2.4GHz
LQP03TN0N6□02	35 min.	40 min.	62 min.	67 min.	71 min.
LQP03TN0N7□02	35 min.	40 min.	62 min.	67 min.	71 min.
LQP03TN0N8□02	35 min.	40 min.	62 min.	67 min.	71 min.
LQP03TN0N9□02	35 min.	40 min.	62 min.	67 min.	71 min.
LQP03TN1N0□02	35 min.	40 min.	62 min.	67 min.	71 min.
LQP03TN1N1□02	35 min.	40 min.	62 min.	67 min.	71 min.
LQP03TN1N2□02	31	34	51	54	59
LQP03TN1N3□02	34	36	55	58	64
LQP03TN1N4□02	31	34	52	55	61
LQP03TN1N5□02	29	31	47	49	54
LQP03TN1N6□02	30	32	47	49	54
LQP03TN1N7□02	30	31	47	49	53
LQP03TN1N8□02	32	34	50	53	57
LQP03TN1N9□02	29	31	45	48	52
LQP03TN2N0□02	28	30	44	46	50
LQP03TN2N1□02	30	31	46	48	52
LQP03TN2N2□02	30	32	46	48	52
LQP03TN2N3□02	29	30	44	46	50
LQP03TN2N4□02	28	30	43	45	49
LQP03TN2N5□02	27	29	41	43	47

Continued on the following page.

△Note • Please read rating and △CAUTION (for storage, operating, rating, soldering, mounting and handling) in this catalog to prevent smoking and/or burning, etc.
• This catalog has only typical specifications. Therefore, please approve our product specifications or transact the approval sheet for product specifications before ordering.

Part Number	Q (Typ.)				
	800MHz	900MHz	1.8GHz	2.0GHz	2.4GHz
LQP03TN2N6□02	26	28	40	42	46
LQP03TN2N7□02	28	29	42	44	47
LQP03TN2N8□02	27	28	39	41	45
LQP03TN2N9□02	27	28	41	42	45
LQP03TN3N0□02	29	31	44	45	48
LQP03TN3N1□02	28	29	40	42	46
LQP03TN3N2□02	28	29	39	41	44
LQP03TN3N3□02	25	26	37	39	42
LQP03TN3N4□02	25	27	37	38	41
LQP03TN3N5□02	27	28	40	41	43
LQP03TN3N6□02	26	27	38	39	41
LQP03TN3N7□02	26	27	38	39	41
LQP03TN3N8□02	25	27	37	38	39
LQP03TN3N9□02	24	26	36	37	39
LQP03TN4N0□02	26	27	37	38	40
LQP03TN4N1□02	25	26	36	37	39
LQP03TN4N2□02	25	27	37	38	40
LQP03TN4N3□02	24	26	36	37	39
LQP03TN4N7□02	25	27	37	38	39
LQP03TN5N1□02	26	28	35	36	37
LQP03TN5N6□02	25	26	36	37	38
LQP03TN6N2□02	23	25	33	34	35
LQP03TN6N8□02	25	27	36	37	37
LQP03TN7N5□02	25	26	34	35	35
LQP03TN8N2□02	24	25	33	34	33
LQP03TN9N1□02	25	26	32	32	31
LQP03TN10N□02	24	26	32	32	32
LQP03TN11N□02	24	25	29	29	27
LQP03TN12N□02	23	24	27	26	23
LQP03TN13N□02	23	24	27	26	22
LQP03TN15N□02	23	24	25	24	19
LQP03TN16N□02	23	24	24	23	18
LQP03TN18N□02	23	24	23	20	14
LQP03TN20N□02	21	22	22	20	15
LQP03TN22N□02	22	22	21	-	-
LQP03TN24N□02	21	21	19	-	-
LQP03TN27N□02	21	22	21	-	-
LQP03TN30N□02	19	20	-	-	-
LQP03TN33N□02	20	20	-	-	-
LQP03TN36N□02	18	18	-	-	-
LQP03TN39N□02	18	18	-	-	-
LQP03TN43N□02	17	16	-	-	-
LQP03TN47N□02	17	16	-	-	-
LQP03TN51N□02	17	17	-	-	-
LQP03TN56N□02	16	16	-	-	-
LQP03TN62N□02	15	14	-	-	-
LQP03TN68N□02	11	10	-	-	-
LQP03TN75N□02	10	9	-	-	-
LQP03TN82N□02	11	10	-	-	-
LQP03TN91N□02	9	8	-	-	-
LQP03TNR10□02	8	6	-	-	-
LQP03TNR11□02	7	5	-	-	-
LQP03TNR12□02	7	4	-	-	-

△Note • Please read rating and △CAUTION (for storage, operating, rating, soldering, mounting and handling) in this catalog to prevent smoking and/or burning, etc.
 • This catalog has only typical specifications. Therefore, please approve our product specifications or transact the approval sheet for product specifications before ordering.

LQP15MN_02 Series 0402/1005 (inch/mm)

Size Code 0402 (1005) in inch (in mm), Tight Inductance Tolerance, Film Type

■ Appearance/Dimensions

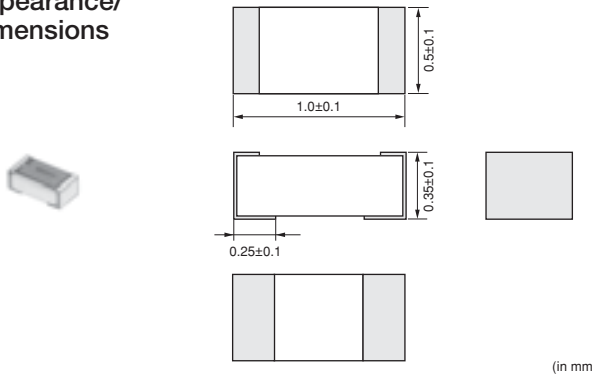

■ Packaging

Code	Packaging	Minimum Quantity
D	ø180mm Paper Taping	10000
J	ø330mm Paper Taping	50000
B	Packing in Bulk	500



Refer to pages 227 to 230 for mounting information.

■ Rated Value (□: packaging code)

Part Number	Inductance	Inductance Test Frequency	Rated Current	Max. of DC Resistance	Q (min.)	Q Test Frequency	Self-Resonance Frequency (min.)	
LQP15MN1N0B02□	1.0nH ±0.1nH	500MHz	400mA	0.1Ω	13	500MHz	6000MHz	Kit
LQP15MN1N0W02□	1.0nH ±0.05nH	500MHz	400mA	0.1Ω	13	500MHz	6000MHz	
LQP15MN1N1B02□	1.1nH ±0.1nH	500MHz	390mA	0.1Ω	13	500MHz	6000MHz	Kit
LQP15MN1N1W02□	1.1nH ±0.05nH	500MHz	390mA	0.1Ω	13	500MHz	6000MHz	
LQP15MN1N2B02□	1.2nH ±0.1nH	500MHz	390mA	0.1Ω	13	500MHz	6000MHz	Kit
LQP15MN1N2W02□	1.2nH ±0.05nH	500MHz	390mA	0.1Ω	13	500MHz	6000MHz	
LQP15MN1N3B02□	1.3nH ±0.1nH	500MHz	280mA	0.2Ω	13	500MHz	6000MHz	Kit
LQP15MN1N3W02□	1.3nH ±0.05nH	500MHz	280mA	0.2Ω	13	500MHz	6000MHz	
LQP15MN1N4W02□	1.4nH ±0.05nH	500MHz	280mA	0.2Ω	13	500MHz	6000MHz	
LQP15MN1N5B02□	1.5nH ±0.1nH	500MHz	280mA	0.2Ω	13	500MHz	6000MHz	Kit
LQP15MN1N5W02□	1.5nH ±0.05nH	500MHz	280mA	0.2Ω	13	500MHz	6000MHz	
LQP15MN1N6B02□	1.6nH ±0.1nH	500MHz	220mA	0.3Ω	13	500MHz	6000MHz	Kit
LQP15MN1N6W02□	1.6nH ±0.05nH	500MHz	220mA	0.3Ω	13	500MHz	6000MHz	
LQP15MN1N7W02□	1.7nH ±0.05nH	500MHz	280mA	0.2Ω	13	500MHz	6000MHz	
LQP15MN1N8B02□	1.8nH ±0.1nH	500MHz	280mA	0.2Ω	13	500MHz	6000MHz	Kit
LQP15MN1N8W02□	1.8nH ±0.05nH	500MHz	280mA	0.2Ω	13	500MHz	6000MHz	
LQP15MN1N9W02□	1.9nH ±0.05nH	500MHz	220mA	0.3Ω	13	500MHz	6000MHz	
LQP15MN2N0B02□	2.0nH ±0.1nH	500MHz	220mA	0.3Ω	13	500MHz	6000MHz	Kit
LQP15MN2N0W02□	2.0nH ±0.05nH	500MHz	220mA	0.3Ω	13	500MHz	6000MHz	
LQP15MN2N1W02□	2.1nH ±0.05nH	500MHz	220mA	0.3Ω	13	500MHz	6000MHz	
LQP15MN2N2B02□	2.2nH ±0.1nH	500MHz	220mA	0.3Ω	13	500MHz	6000MHz	Kit
LQP15MN2N2W02□	2.2nH ±0.05nH	500MHz	220mA	0.3Ω	13	500MHz	6000MHz	
LQP15MN2N3W02□	2.3nH ±0.05nH	500MHz	220mA	0.3Ω	13	500MHz	6000MHz	
LQP15MN2N4B02□	2.4nH ±0.1nH	500MHz	220mA	0.3Ω	13	500MHz	6000MHz	Kit
LQP15MN2N4W02□	2.4nH ±0.05nH	500MHz	220mA	0.3Ω	13	500MHz	6000MHz	
LQP15MN2N5W02□	2.5nH ±0.05nH	500MHz	220mA	0.3Ω	13	500MHz	6000MHz	
LQP15MN2N6W02□	2.6nH ±0.05nH	500MHz	220mA	0.3Ω	13	500MHz	6000MHz	
LQP15MN2N7B02□	2.7nH ±0.1nH	500MHz	220mA	0.3Ω	13	500MHz	6000MHz	Kit
LQP15MN2N7W02□	2.7nH ±0.05nH	500MHz	220mA	0.3Ω	13	500MHz	6000MHz	
LQP15MN2N8W02□	2.8nH ±0.05nH	500MHz	190mA	0.4Ω	13	500MHz	6000MHz	
LQP15MN2N9W02□	2.9nH ±0.05nH	500MHz	190mA	0.4Ω	13	500MHz	6000MHz	
LQP15MN3N0B02□	3.0nH ±0.1nH	500MHz	190mA	0.4Ω	13	500MHz	6000MHz	Kit

Operating Temperature Range (Self-temperature rise is not included): -40°C~+85°C
For reflow soldering only.

Continued on the following page.

△Note • Please read rating and △CAUTION (for storage, operating, rating, soldering, mounting and handling) in this catalog to prevent smoking and/or burning, etc.
• This catalog has only typical specifications. Therefore, please approve our product specifications or transact the approval sheet for product specifications before ordering.

Part Number	Inductance	Inductance Test Frequency	Rated Current	Max. of DC Resistance	Q (min.)	Q Test Frequency	Self-Resonance Frequency (min.)	
LQP15MN3N0W02□	3.0nH ±0.05nH	500MHz	190mA	0.4Ω	13	500MHz	6000MHz	
LQP15MN3N1W02□	3.1nH ±0.05nH	500MHz	190mA	0.4Ω	13	500MHz	6000MHz	
LQP15MN3N2W02□	3.2nH ±0.05nH	500MHz	190mA	0.4Ω	13	500MHz	6000MHz	
LQP15MN3N3B02□	3.3nH ±0.1nH	500MHz	190mA	0.4Ω	13	500MHz	6000MHz	Kit
LQP15MN3N3W02□	3.3nH ±0.05nH	500MHz	190mA	0.4Ω	13	500MHz	6000MHz	
LQP15MN3N4W02□	3.4nH ±0.05nH	500MHz	170mA	0.5Ω	13	500MHz	6000MHz	
LQP15MN3N5W02□	3.5nH ±0.05nH	500MHz	170mA	0.5Ω	13	500MHz	6000MHz	
LQP15MN3N6B02□	3.6nH ±0.1nH	500MHz	170mA	0.5Ω	13	500MHz	6000MHz	Kit
LQP15MN3N6W02□	3.6nH ±0.05nH	500MHz	170mA	0.5Ω	13	500MHz	6000MHz	
LQP15MN3N7W02□	3.7nH ±0.05nH	500MHz	170mA	0.5Ω	13	500MHz	6000MHz	
LQP15MN3N8W02□	3.8nH ±0.05nH	500MHz	170mA	0.5Ω	13	500MHz	6000MHz	
LQP15MN3N9B02□	3.9nH ±0.1nH	500MHz	170mA	0.5Ω	13	500MHz	6000MHz	Kit
LQP15MN3N9W02□	3.9nH ±0.05nH	500MHz	170mA	0.5Ω	13	500MHz	6000MHz	
LQP15MN4N3B02□	4.3nH ±0.1nH	500MHz	160mA	0.6Ω	13	500MHz	6000MHz	Kit
LQP15MN4N7B02□	4.7nH ±0.1nH	500MHz	160mA	0.6Ω	13	500MHz	6000MHz	Kit
LQP15MN5N1B02□	5.1nH ±0.1nH	500MHz	140mA	0.7Ω	13	500MHz	6000MHz	Kit
LQP15MN5N6B02□	5.6nH ±0.1nH	500MHz	140mA	0.7Ω	13	500MHz	6000MHz	Kit
LQP15MN6N2B02□	6.2nH ±0.1nH	500MHz	130mA	0.9Ω	13	500MHz	6000MHz	Kit
LQP15MN6N8B02□	6.8nH ±0.1nH	500MHz	130mA	0.9Ω	13	500MHz	6000MHz	Kit
LQP15MN7N5B02□	7.5nH ±0.1nH	500MHz	110mA	1.1Ω	13	500MHz	5500MHz	Kit
LQP15MN8N2B02□	8.2nH ±0.1nH	500MHz	110mA	1.1Ω	13	500MHz	5500MHz	Kit
LQP15MN9N1B02□	9.1nH ±0.1nH	500MHz	100mA	1.3Ω	13	500MHz	4500MHz	Kit
LQP15MN10NG02□	10nH ±2%	500MHz	100mA	1.3Ω	13	500MHz	4500MHz	Kit
LQP15MN12NG02□	12nH ±2%	500MHz	90mA	1.6Ω	13	500MHz	3700MHz	Kit
LQP15MN15NG02□	15nH ±2%	500MHz	90mA	1.8Ω	13	500MHz	3300MHz	Kit
LQP15MN18NG02□	18nH ±2%	500MHz	80mA	2.0Ω	13	500MHz	3100MHz	Kit
LQP15MN22NG02□	22nH ±2%	500MHz	70mA	2.6Ω	13	500MHz	2800MHz	Kit
LQP15MN27NG02□	27nH ±2%	500MHz	70mA	3.1Ω	13	500MHz	2500MHz	Kit
LQP15MN33NG02□	33nH ±2%	500MHz	60mA	3.8Ω	13	500MHz	2100MHz	Kit

Operating Temperature Range (Self-temperature rise is not included): -40°C~+85°C
 For reflow soldering only.

■ Q-Frequency Characteristics (Typ.)

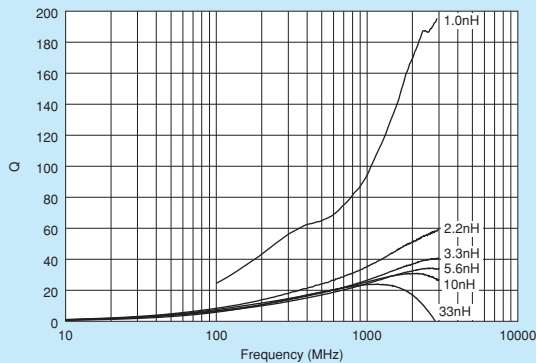

■ Inductance-Frequency Characteristics (Typ.)

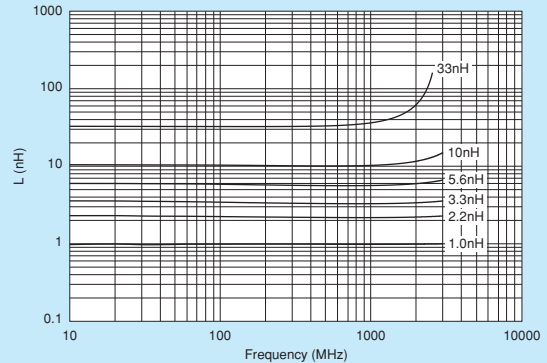

Continued on the following page.

△Note • Please read rating and △CAUTION (for storage, operating, rating, soldering, mounting and handling) in this catalog to prevent smoking and/or burning, etc.
 • This catalog has only typical specifications. Therefore, please approve our product specifications or transact the approval sheet for product specifications before ordering.

Inductors for Power Lines
 Inductors for General Use
 Film Type (Non-Magnetic Core) RF Inductors

■ Reference Data

4991A&16197A

Part Number	Q (Typ.)				
	800MHz	900MHz	1.8GHz	2.0GHz	2.4GHz
LQP15MN1N0□02	80	88	157	172	188
LQP15MN1N1□02	60	65	107	115	125
LQP15MN1N2□02	56	61	100	104	114
LQP15MN1N3□02	46	50	77	81	86
LQP15MN1N4□02	40	44	65	68	73
LQP15MN1N5□02	34	36	55	57	62
LQP15MN1N6□02	25	27	40	42	46
LQP15MN1N7□02	29	32	47	49	53
LQP15MN1N8□02	32	35	51	53	57
LQP15MN1N9□02	34	36	54	56	60
LQP15MN2N0□02	32	34	51	53	57
LQP15MN2N1□02	34	37	55	57	61
LQP15MN2N2□02	31	33	49	51	55
LQP15MN2N3□02	32	34	51	54	58
LQP15MN2N4□02	32	34	51	53	57
LQP15MN2N5□02	31	33	50	52	56
LQP15MN2N6□02	29	32	47	49	53
LQP15MN2N7□02	29	32	47	49	53
LQP15MN2N8□02	28	30	45	46	50
LQP15MN2N9□02	28	30	44	45	48
LQP15MN3N0□02	27	29	43	44	48
LQP15MN3N1□02	25	27	39	41	44
LQP15MN3N2□02	24	26	36	37	40
LQP15MN3N3□02	23	25	36	37	39
LQP15MN3N4□02	24	25	36	37	39
LQP15MN3N5□02	25	27	38	39	42
LQP15MN3N6□02	24	26	38	39	42
LQP15MN3N7□02	25	27	38	39	42
LQP15MN3N8□02	25	26	37	38	41
LQP15MN3N9□02	25	27	38	40	42
LQP15MN4N3□02	25	26	38	39	42
LQP15MN4N7□02	26	28	40	41	43
LQP15MN5N1□02	26	27	39	40	42
LQP15MN5N6□02	22	23	32	32	34
LQP15MN6N2□02	22	23	33	33	35
LQP15MN6N8□02	22	24	32	33	34
LQP15MN7N5□02	23	24	32	33	34
LQP15MN8N2□02	23	25	34	35	36
LQP15MN9N1□02	23	24	33	33	34
LQP15MN10N□02	23	24	31	31	-
LQP15MN12N□02	24	26	32	32	-
LQP15MN15N□02	23	24	28	28	-
LQP15MN18N□02	22	23	25	24	-
LQP15MN22N□02	23	24	24	22	-
LQP15MN27N□02	23	24	22	20	-
LQP15MN33N□02	22	23	20	-	-

△Note • Please read rating and △CAUTION (for storage, operating, rating, soldering, mounting and handling) in this catalog to prevent smoking and/or burning, etc.
 • This catalog has only typical specifications. Therefore, please approve our product specifications or transact the approval sheet for product specifications before ordering.

LQP18MN_02

Series 0603/1608 (inch/mm)

Size Code 0603 (1608) in inch (in mm), Film Type

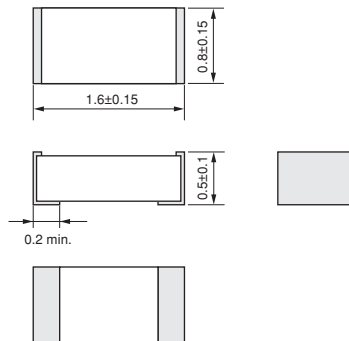
■ Appearance/
Dimensions

(in mm)

■ Packaging

Code	Packaging	Minimum Quantity
D	ø180mm Paper Taping	4000
J	ø330mm Paper Taping	10000
B	Packing in Bulk	500



Refer to pages 227 to 230 for mounting information.

■ Rated Value (□: packaging code)

Part Number	Inductance	Inductance Test Frequency	Rated Current	Max. of DC Resistance	Q (min.)	Q Test Frequency	Self-Resonance Frequency (min.)
LQP18MN1N3C02□	1.3nH ±0.2nH	500MHz	300mA	0.3Ω	17	500MHz	6000MHz
LQP18MN1N5C02□	1.5nH ±0.2nH	500MHz	300mA	0.3Ω	17	500MHz	6000MHz
LQP18MN1N8C02□	1.8nH ±0.2nH	500MHz	250mA	0.4Ω	17	500MHz	6000MHz
LQP18MN2N2C02□	2.2nH ±0.2nH	500MHz	250mA	0.4Ω	17	500MHz	6000MHz
LQP18MN2N7C02□	2.7nH ±0.2nH	500MHz	250mA	0.4Ω	17	500MHz	6000MHz
LQP18MN3N3C02□	3.3nH ±0.2nH	500MHz	250mA	0.4Ω	17	500MHz	6000MHz
LQP18MN3N9C02□	3.9nH ±0.2nH	500MHz	200mA	0.5Ω	17	500MHz	5900MHz
LQP18MN4N7C02□	4.7nH ±0.2nH	500MHz	200mA	0.5Ω	17	500MHz	5200MHz
LQP18MN5N6C02□	5.6nH ±0.2nH	500MHz	200mA	0.6Ω	17	500MHz	4700MHz
LQP18MN6N8C02□	6.8nH ±0.2nH	500MHz	200mA	0.7Ω	17	500MHz	4300MHz
LQP18MN8N2C02□	8.2nH ±0.2nH	500MHz	150mA	0.8Ω	17	500MHz	3600MHz
LQP18MN10NG02□	10nH ±2%	500MHz	150mA	1.0Ω	17	500MHz	3400MHz
LQP18MN12NG02□	12nH ±2%	500MHz	150mA	1.0Ω	17	500MHz	3000MHz
LQP18MN15NG02□	15nH ±2%	500MHz	150mA	1.3Ω	17	500MHz	2700MHz
LQP18MN18NG02□	18nH ±2%	500MHz	100mA	1.5Ω	17	500MHz	2300MHz
LQP18MN22NG02□	22nH ±2%	500MHz	100mA	1.9Ω	17	500MHz	2100MHz
LQP18MN27NG02□	27nH ±2%	500MHz	100mA	2.4Ω	17	500MHz	1900MHz
LQP18MN33NG02□	33nH ±2%	500MHz	100mA	2.8Ω	17	500MHz	1700MHz
LQP18MN39NG02□	39nH ±2%	500MHz	100mA	2.8Ω	17	500MHz	1400MHz
LQP18MN47NG02□	47nH ±2%	300MHz	100mA	2.2Ω	17	300MHz	1200MHz
LQP18MN56NG02□	56nH ±2%	300MHz	50mA	3.4Ω	17	300MHz	1000MHz
LQP18MN68NG02□	68nH ±2%	300MHz	50mA	3.5Ω	17	300MHz	900MHz
LQP18MN82NG02□	82nH ±2%	300MHz	50mA	4.6Ω	17	300MHz	800MHz
LQP18MNR10G02□	100nH ±2%	300MHz	50mA	6.1Ω	17	300MHz	700MHz

Operating Temperature Range (Self-temperature rise is not included): -40°C~+85°C
For reflow soldering only.

Continued on the following page.

■ Q-Frequency Characteristics (Typ.)

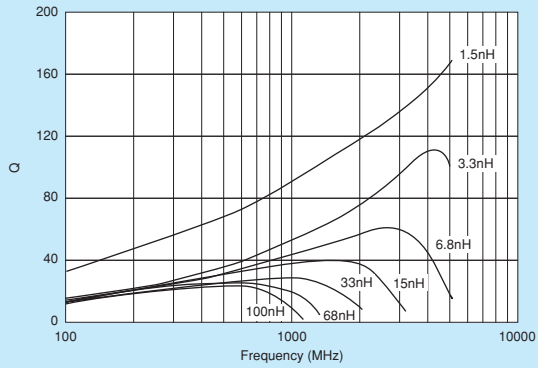

■ Inductance-Frequency Characteristics (Typ.)

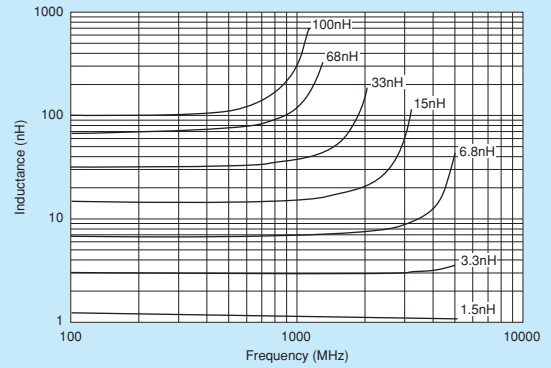

⚠Note • Please read rating and ⚠CAUTION (for storage, operating, rating, soldering, mounting and handling) in this catalog to prevent smoking and/or burning, etc.
• This catalog has only typical specifications. Therefore, please approve our product specifications or transact the approval sheet for product specifications before ordering.

LQW03AW_00 Series

Suitable for Mounting in a Narrow Space in Antenna Matching Circuits

■ Appearance/Dimensions

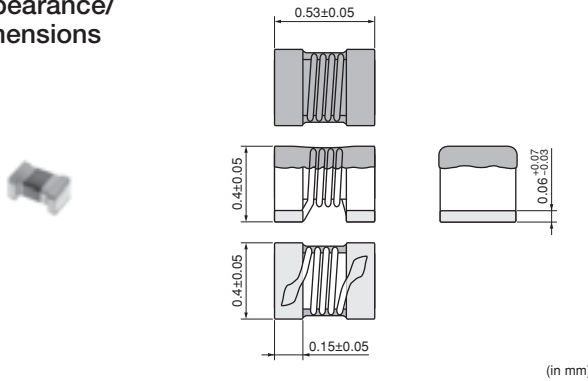

■ Packaging

Code	Packaging	Minimum Quantity
D	ø180mm Paper Taping	10000



Refer to pages 227 to 230 for mounting information.

■ Rated Value (□: packaging code)

Part Number	Inductance	Inductance Test Frequency	Rated Current	Max. of DC Resistance	Q (min.)	Q Test Frequency	Self-Resonance Frequency (min.)	
LQW03AW5N4C00□	5.4nH ±0.2nH	100MHz	420mA	0.21Ω	46 (Typ.)	900MHz	8.5GHz	New
LQW03AW5N4J00□	5.4nH ±5%	100MHz	420mA	0.21Ω	46 (Typ.)	900MHz	8.5GHz	New Kit
LQW03AW5N6C00□	5.6nH ±0.2nH	100MHz	330mA	0.33Ω	37 (Typ.)	900MHz	8.3GHz	New
LQW03AW5N6J00□	5.6nH ±5%	100MHz	330mA	0.33Ω	37 (Typ.)	900MHz	8.3GHz	New Kit
LQW03AW5N8C00□	5.8nH ±0.2nH	100MHz	460mA	0.16Ω	47 (Typ.)	900MHz	8.8GHz	New
LQW03AW5N8J00□	5.8nH ±5%	100MHz	460mA	0.16Ω	47 (Typ.)	900MHz	8.8GHz	New Kit
LQW03AW6N8C00□	6.8nH ±0.2nH	100MHz	460mA	0.18Ω	42 (Typ.)	900MHz	7.7GHz	New
LQW03AW6N8J00□	6.8nH ±5%	100MHz	460mA	0.18Ω	42 (Typ.)	900MHz	7.7GHz	New Kit
LQW03AW7N5C00□	7.5nH ±0.2nH	100MHz	400mA	0.24Ω	41 (Typ.)	900MHz	7.5GHz	New
LQW03AW7N5J00□	7.5nH ±5%	100MHz	400mA	0.24Ω	41 (Typ.)	900MHz	7.5GHz	New Kit
LQW03AW8N7C00□	8.7nH ±0.2nH	100MHz	290mA	0.42Ω	39 (Typ.)	900MHz	7.5GHz	New
LQW03AW8N7J00□	8.7nH ±5%	100MHz	290mA	0.42Ω	39 (Typ.)	900MHz	7.5GHz	New Kit
LQW03AW9N1C00□	9.1nH ±0.2nH	100MHz	460mA	0.22Ω	46 (Typ.)	900MHz	6.4GHz	New
LQW03AW9N1J00□	9.1nH ±5%	100MHz	460mA	0.22Ω	46 (Typ.)	900MHz	6.4GHz	New Kit
LQW03AW13NJ00□	13nH ±5%	100MHz	280mA	0.54Ω	39 (Typ.)	900MHz	5.9GHz	New Kit

Operating Temperature Range (Self-temperature rise is included): -55°C~+125°C
For reflow soldering only.

■ Q-Frequency Characteristics (Typ.)

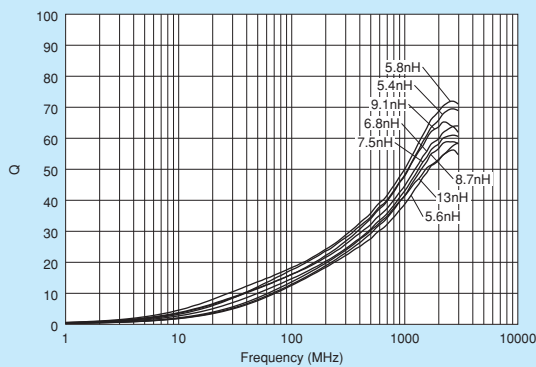

■ Inductance-Frequency Characteristics (Typ.)

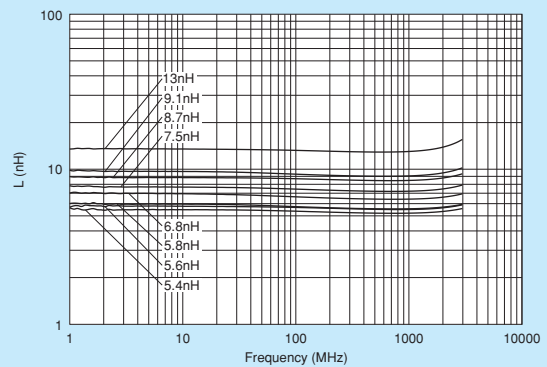

Continued on the following page.

△Note • Please read rating and △CAUTION (for storage, operating, rating, soldering, mounting and handling) in this catalog to prevent smoking and/or burning, etc.
• This catalog has only typical specifications. Therefore, please approve our product specifications or transact the approval sheet for product specifications before ordering.

Reference Data

4991A&16197A

Part Number	Inductance (nH)	Q (Typ.)				
	Nominal	800MHz	900MHz	1.8GHz	2.0GHz	2.4GHz
LQW03AW5N4	5.4	43	46	64	66	69
LQW03AW5N6	5.6	34	37	51	53	56
LQW03AW5N8	5.8	44	48	67	68	71
LQW03AW6N8	6.8	40	42	59	60	63
LQW03AW7N5	7.5	38	41	57	58	61
LQW03AW8N7	8.7	37	39	55	56	59
LQW03AW9N1	9.1	42	46	63	63	65
LQW03AW13N	13.0	37	40	52	53	55

⚠Note • Please read rating and ⚠CAUTION (for storage, operating, rating, soldering, mounting and handling) in this catalog to prevent smoking and/or burning, etc.
• This catalog has only typical specifications. Therefore, please approve our product specifications or transact the approval sheet for product specifications before ordering.

LQW04AN_00

Series 03015/0804 (inch/mm)

Size Code 03015 (0804) in inch (in mm), Wound Type

Appearance/Dimensions

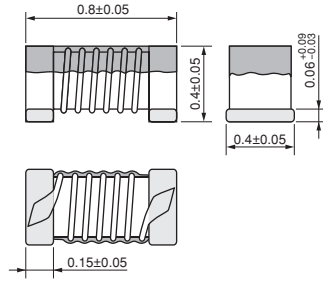

(in mm)

Packaging

Code	Packaging	Minimum Quantity
D	ø180mm Paper Taping	10000
B	Packing in Bulk	500



Refer to pages 227 to 230 for mounting information.

Rated Value (□: packaging code)

Part Number	Inductance	Inductance Test Frequency	Rated Current	Max. of DC Resistance	Q (min.)	Q Test Frequency	Self-Resonance Frequency (min.)	
LQW04AN1N1C00□	1.1nH ±0.2nH	100MHz	990mA	0.03Ω	15	250MHz	20.0GHz	Kit
LQW04AN1N1D00□	1.1nH ±0.5nH	100MHz	990mA	0.03Ω	15	250MHz	20.0GHz	
LQW04AN1N8C00□	1.8nH ±0.2nH	100MHz	700mA	0.06Ω	15	250MHz	17.0GHz	Kit
LQW04AN1N8D00□	1.8nH ±0.5nH	100MHz	700mA	0.06Ω	15	250MHz	17.0GHz	
LQW04AN2N7C00□	2.7nH ±0.2nH	100MHz	570mA	0.07Ω	15	250MHz	15.0GHz	Kit
LQW04AN2N7D00□	2.7nH ±0.5nH	100MHz	570mA	0.07Ω	15	250MHz	15.0GHz	
LQW04AN3N0C00□	3.0nH ±0.2nH	100MHz	620mA	0.07Ω	15	250MHz	13.0GHz	Kit
LQW04AN3N0D00□	3.0nH ±0.5nH	100MHz	620mA	0.07Ω	15	250MHz	13.0GHz	
LQW04AN3N3C00□	3.3nH ±0.2nH	100MHz	440mA	0.14Ω	10	250MHz	10.0GHz	Kit
LQW04AN3N3D00□	3.3nH ±0.5nH	100MHz	440mA	0.14Ω	10	250MHz	10.0GHz	
LQW04AN3N6C00□	3.6nH ±0.2nH	100MHz	530mA	0.10Ω	15	250MHz	13.0GHz	Kit
LQW04AN3N6D00□	3.6nH ±0.5nH	100MHz	530mA	0.10Ω	15	250MHz	13.0GHz	
LQW04AN3N9C00□	3.9nH ±0.2nH	100MHz	530mA	0.10Ω	15	250MHz	12.0GHz	Kit
LQW04AN3N9D00□	3.9nH ±0.5nH	100MHz	530mA	0.10Ω	15	250MHz	12.0GHz	
LQW04AN4N3C00□	4.3nH ±0.2nH	100MHz	530mA	0.10Ω	15	250MHz	11.0GHz	Kit
LQW04AN4N3D00□	4.3nH ±0.5nH	100MHz	530mA	0.10Ω	15	250MHz	11.0GHz	
LQW04AN4N7C00□	4.7nH ±0.2nH	100MHz	440mA	0.14Ω	20	250MHz	10.0GHz	Kit
LQW04AN4N7D00□	4.7nH ±0.5nH	100MHz	440mA	0.14Ω	20	250MHz	10.0GHz	
LQW04AN5N1C00□	5.1nH ±0.2nH	100MHz	470mA	0.12Ω	20	250MHz	10.0GHz	Kit
LQW04AN5N1D00□	5.1nH ±0.5nH	100MHz	470mA	0.12Ω	20	250MHz	10.0GHz	
LQW04AN5N6C00□	5.6nH ±0.2nH	100MHz	470mA	0.12Ω	20	250MHz	9.0GHz	Kit
LQW04AN5N6D00□	5.6nH ±0.5nH	100MHz	470mA	0.12Ω	20	250MHz	9.0GHz	
LQW04AN6N2C00□	6.2nH ±0.2nH	100MHz	390mA	0.19Ω	20	250MHz	9.0GHz	Kit
LQW04AN6N2D00□	6.2nH ±0.5nH	100MHz	390mA	0.19Ω	20	250MHz	9.0GHz	
LQW04AN6N8C00□	6.8nH ±0.2nH	100MHz	440mA	0.14Ω	20	250MHz	9.0GHz	Kit
LQW04AN6N8D00□	6.8nH ±0.5nH	100MHz	440mA	0.14Ω	20	250MHz	9.0GHz	
LQW04AN7N5C00□	7.5nH ±0.2nH	100MHz	440mA	0.14Ω	20	250MHz	8.0GHz	Kit
LQW04AN7N5D00□	7.5nH ±0.5nH	100MHz	440mA	0.14Ω	20	250MHz	8.0GHz	
LQW04AN8N2C00□	8.2nH ±0.2nH	100MHz	350mA	0.23Ω	20	250MHz	8.0GHz	Kit
LQW04AN8N2D00□	8.2nH ±0.5nH	100MHz	350mA	0.23Ω	20	250MHz	8.0GHz	
LQW04AN9N1C00□	9.1nH ±0.2nH	100MHz	400mA	0.16Ω	20	250MHz	7.0GHz	Kit
LQW04AN9N1D00□	9.1nH ±0.5nH	100MHz	400mA	0.16Ω	20	250MHz	7.0GHz	

Operating Temperature Range (Self-temperature rise is not included): -55°C~+125°C
For reflow soldering only.

Continued on the following page.

[△]Note • Please read rating and [△]CAUTION (for storage, operating, rating, soldering, mounting and handling) in this catalog to prevent smoking and/or burning, etc.
• This catalog has only typical specifications. Therefore, please approve our product specifications or transact the approval sheet for product specifications before ordering.

Part Number	Inductance	Inductance Test Frequency	Rated Current	Max. of DC Resistance	Q (min.)	Q Test Frequency	Self-Resonance Frequency (min.)	
LQW04AN10NH00	10nH ±3%	100MHz	330mA	0.26Ω	20	250MHz	7.0GHz	Kit
LQW04AN10NJ00	10nH ±5%	100MHz	330mA	0.26Ω	20	250MHz	7.0GHz	
LQW04AN11NH00	11nH ±3%	100MHz	310mA	0.28Ω	15	250MHz	7.0GHz	Kit
LQW04AN11NJ00	11nH ±5%	100MHz	310mA	0.28Ω	15	250MHz	7.0GHz	
LQW04AN12NH00	12nH ±3%	100MHz	310mA	0.28Ω	15	250MHz	6.0GHz	Kit
LQW04AN12NJ00	12nH ±5%	100MHz	310mA	0.28Ω	15	250MHz	6.0GHz	
LQW04AN13NH00	13nH ±3%	100MHz	280mA	0.34Ω	15	250MHz	6.0GHz	Kit
LQW04AN13NJ00	13nH ±5%	100MHz	280mA	0.34Ω	15	250MHz	6.0GHz	
LQW04AN15NH00	15nH ±3%	100MHz	240mA	0.48Ω	15	250MHz	5.5GHz	Kit
LQW04AN15NJ00	15nH ±5%	100MHz	240mA	0.48Ω	15	250MHz	5.5GHz	
LQW04AN16NH00	16nH ±3%	100MHz	270mA	0.38Ω	15	250MHz	5.5GHz	Kit
LQW04AN16NJ00	16nH ±5%	100MHz	270mA	0.38Ω	15	250MHz	5.5GHz	
LQW04AN18NH00	18nH ±3%	100MHz	220mA	0.54Ω	15	250MHz	5.0GHz	Kit
LQW04AN18NJ00	18nH ±5%	100MHz	220mA	0.54Ω	15	250MHz	5.0GHz	
LQW04AN19NH00	19nH ±3%	100MHz	160mA	0.73Ω	15	250MHz	5.0GHz	Kit
LQW04AN19NJ00	19nH ±5%	100MHz	160mA	0.73Ω	15	250MHz	5.0GHz	
LQW04AN20NH00	20nH ±3%	100MHz	210mA	0.56Ω	15	250MHz	5.0GHz	Kit
LQW04AN20NJ00	20nH ±5%	100MHz	210mA	0.56Ω	15	250MHz	5.0GHz	
LQW04AN22NH00	22nH ±3%	100MHz	200mA	0.63Ω	15	250MHz	5.0GHz	Kit
LQW04AN22NJ00	22nH ±5%	100MHz	200mA	0.63Ω	15	250MHz	5.0GHz	
LQW04AN23NH00	23nH ±3%	100MHz	160mA	0.95Ω	15	250MHz	4.0GHz	Kit
LQW04AN23NJ00	23nH ±5%	100MHz	160mA	0.95Ω	15	250MHz	4.0GHz	
LQW04AN24NH00	24nH ±3%	100MHz	160mA	0.95Ω	15	250MHz	4.0GHz	Kit
LQW04AN24NJ00	24nH ±5%	100MHz	160mA	0.95Ω	15	250MHz	4.0GHz	
LQW04AN25NH00	25nH ±3%	100MHz	160mA	0.95Ω	15	250MHz	4.0GHz	Kit
LQW04AN25NJ00	25nH ±5%	100MHz	160mA	0.95Ω	15	250MHz	4.0GHz	
LQW04AN27NH00	27nH ±3%	100MHz	160mA	0.95Ω	15	250MHz	4.0GHz	Kit
LQW04AN27NJ00	27nH ±5%	100MHz	160mA	0.95Ω	15	250MHz	4.0GHz	
LQW04AN33NH00	33nH ±3%	100MHz	140mA	1.11Ω	15	250MHz	4.0GHz	Kit
LQW04AN33NJ00	33nH ±5%	100MHz	140mA	1.11Ω	15	250MHz	4.0GHz	

Operating Temperature Range (Self-temperature rise is not included): -55°C~+125°C
For reflow soldering only.

■ Q-Frequency Characteristics (Typ.)

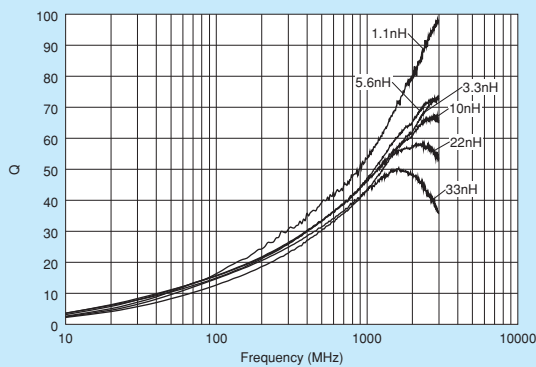

■ Inductance-Frequency Characteristics (Typ.)

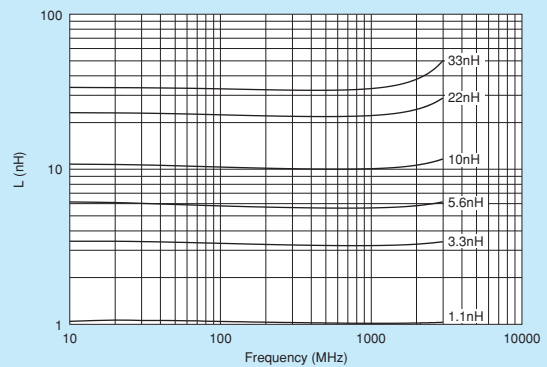

Continued on the following page.

⚠Note • Please read rating and ⚠CAUTION (for storage, operating, rating, soldering, mounting and handling) in this catalog to prevent smoking and/or burning, etc.
• This catalog has only typical specifications. Therefore, please approve our product specifications or transact the approval sheet for product specifications before ordering.

Reference Data

4991A&16197A

Part Number	Inductance (nH)	Q (Typ.)				
	Nominal	800MHz	900MHz	1.8GHz	2.0GHz	2.4GHz
LQW04AN1N1	1.1	61	65	79	85	92
LQW04AN1N8	1.8	48	52	75	80	88
LQW04AN2N7	2.7	46	50	70	75	85
LQW04AN3N0	3.0	47	50	70	75	85
LQW04AN3N3	3.3	40	43	62	64	69
LQW04AN3N6	3.6	46	48	69	72	78
LQW04AN3N9	3.9	46	48	69	72	79
LQW04AN4N3	4.3	47	50	69	73	79
LQW04AN4N7	4.7	43	45	63	67	72
LQW04AN5N1	5.1	47	49	69	72	80
LQW04AN5N6	5.6	47	49	69	72	79
LQW04AN6N2	6.2	42	45	63	65	70
LQW04AN6N8	6.8	45	48	66	68	74
LQW04AN7N5	7.5	45	47	66	67	70
LQW04AN8N2	8.2	43	45	61	63	67
LQW04AN9N1	9.1	45	47	65	66	68
LQW04AN10N	10	43	46	61	63	65
LQW04AN11N	11	43	46	63	65	67
LQW04AN12N	12	44	47	63	64	66
LQW04AN13N	13	44	46	62	64	66
LQW04AN15N	15	43	45	59	60	61
LQW04AN16N	16	43	47	60	61	61
LQW04AN18N	18	42	45	57	58	57
LQW04AN20N	20	42	45	57	58	55
LQW04AN22N	22	42	46	56	57	55
LQW04AN27N	27	42	44	51	50	47
LQW04AN33N	33	43	45	52	50	47

Inductors for Power Lines

Inductors for General Use

Wire Wound Type (Non-Magnetic Core)
RF Inductors

△Note • Please read rating and △CAUTION (for storage, operating, rating, soldering, mounting and handling) in this catalog to prevent smoking and/or burning, etc.
• This catalog has only typical specifications. Therefore, please approve our product specifications or transact the approval sheet for product specifications before ordering.

LQW15AN_00 Series 0402/1005 (inch/mm)

Size Code 0402 (1005) in inch (in mm), Wound Type

■ Appearance/Dimensions

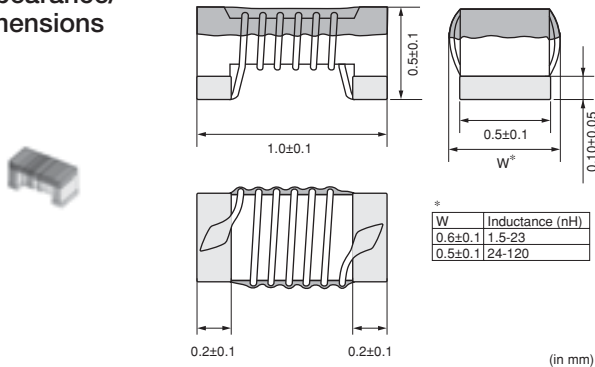

■ Packaging

Code	Packaging	Minimum Quantity
D	ø180mm Paper Taping	10000
B	Packing in Bulk	500



Refer to pages 227 to 230 for mounting information.

■ Rated Value (□: packaging code)

Part Number	Inductance	Inductance Test Frequency	Rated Current	Max. of DC Resistance	Q (min.)	Q Test Frequency	Self-Resonance Frequency (min.)	
LQW15AN1N5B00□	1.5nH ±0.1nH	100MHz	1000mA	0.03Ω	10	250MHz	18.0GHz	Kit
LQW15AN1N5C00□	1.5nH ±0.2nH	100MHz	1000mA	0.03Ω	10	250MHz	18.0GHz	
LQW15AN1N5D00□	1.5nH ±0.5nH	100MHz	1000mA	0.03Ω	10	250MHz	18.0GHz	
LQW15AN2N4B00□	2.4nH ±0.1nH	100MHz	850mA	0.05Ω	20	250MHz	15.0GHz	Kit
LQW15AN2N4C00□	2.4nH ±0.2nH	100MHz	850mA	0.05Ω	20	250MHz	15.0GHz	
LQW15AN2N4D00□	2.4nH ±0.5nH	100MHz	850mA	0.05Ω	20	250MHz	15.0GHz	
LQW15AN2N5B00□	2.5nH ±0.1nH	100MHz	850mA	0.05Ω	20	250MHz	15.0GHz	Kit
LQW15AN2N5C00□	2.5nH ±0.2nH	100MHz	850mA	0.05Ω	20	250MHz	15.0GHz	
LQW15AN2N5D00□	2.5nH ±0.5nH	100MHz	850mA	0.05Ω	20	250MHz	15.0GHz	
LQW15AN2N7B00□	2.7nH ±0.1nH	100MHz	850mA	0.05Ω	20	250MHz	15.0GHz	Kit
LQW15AN2N7C00□	2.7nH ±0.2nH	100MHz	850mA	0.05Ω	20	250MHz	15.0GHz	
LQW15AN2N7D00□	2.7nH ±0.5nH	100MHz	850mA	0.05Ω	20	250MHz	15.0GHz	
LQW15AN2N9B00□	2.9nH ±0.1nH	100MHz	750mA	0.07Ω	20	250MHz	15.0GHz	Kit
LQW15AN2N9C00□	2.9nH ±0.2nH	100MHz	750mA	0.07Ω	20	250MHz	15.0GHz	
LQW15AN2N9D00□	2.9nH ±0.5nH	100MHz	750mA	0.07Ω	20	250MHz	15.0GHz	
LQW15AN3N9B00□	3.9nH ±0.1nH	100MHz	750mA	0.07Ω	25	250MHz	10.0GHz	Kit
LQW15AN3N9C00□	3.9nH ±0.2nH	100MHz	750mA	0.07Ω	25	250MHz	10.0GHz	
LQW15AN3N9D00□	3.9nH ±0.5nH	100MHz	750mA	0.07Ω	25	250MHz	10.0GHz	
LQW15AN4N1B00□	4.1nH ±0.1nH	100MHz	750mA	0.07Ω	25	250MHz	10.0GHz	Kit
LQW15AN4N1C00□	4.1nH ±0.2nH	100MHz	750mA	0.07Ω	25	250MHz	10.0GHz	
LQW15AN4N1D00□	4.1nH ±0.5nH	100MHz	750mA	0.07Ω	25	250MHz	10.0GHz	
LQW15AN4N3B00□	4.3nH ±0.1nH	100MHz	750mA	0.07Ω	25	250MHz	10.0GHz	Kit
LQW15AN4N3C00□	4.3nH ±0.2nH	100MHz	750mA	0.07Ω	25	250MHz	10.0GHz	
LQW15AN4N3D00□	4.3nH ±0.5nH	100MHz	750mA	0.07Ω	25	250MHz	10.0GHz	
LQW15AN4N7B00□	4.7nH ±0.1nH	100MHz	750mA	0.07Ω	25	250MHz	8.0GHz	Kit
LQW15AN4N7C00□	4.7nH ±0.2nH	100MHz	750mA	0.07Ω	25	250MHz	8.0GHz	
LQW15AN4N7D00□	4.7nH ±0.5nH	100MHz	750mA	0.07Ω	25	250MHz	8.0GHz	
LQW15AN5N1B00□	5.1nH ±0.1nH	100MHz	600mA	0.12Ω	25	250MHz	8.0GHz	Kit
LQW15AN5N1C00□	5.1nH ±0.2nH	100MHz	600mA	0.12Ω	25	250MHz	8.0GHz	
LQW15AN5N1D00□	5.1nH ±0.5nH	100MHz	600mA	0.12Ω	25	250MHz	8.0GHz	
LQW15AN5N8B00□	5.8nH ±0.1nH	100MHz	700mA	0.12Ω	25	250MHz	8.0GHz	Kit
LQW15AN5N8C00□	5.8nH ±0.2nH	100MHz	700mA	0.12Ω	25	250MHz	8.0GHz	

Operating Temperature Range (Self-temperature rise is not included): -55°C~+125°C
For reflow soldering only.



Continued on the following page.

△Note • Please read rating and △CAUTION (for storage, operating, rating, soldering, mounting and handling) in this catalog to prevent smoking and/or burning, etc.
• This catalog has only typical specifications. Therefore, please approve our product specifications or transact the approval sheet for product specifications before ordering.

Part Number	Inductance	Inductance Test Frequency	Rated Current	Max. of DC Resistance	Q (min.)	Q Test Frequency	Self-Resonance Frequency (min.)	
LQW15AN5N8D00□	5.8nH ±0.5nH	100MHz	700mA	0.12Ω	25	250MHz	8.0GHz	
LQW15AN6N2B00□	6.2nH ±0.1nH	100MHz	700mA	0.09Ω	25	250MHz	8.0GHz	Kit
LQW15AN6N2C00□	6.2nH ±0.2nH	100MHz	700mA	0.09Ω	25	250MHz	8.0GHz	
LQW15AN6N2D00□	6.2nH ±0.5nH	100MHz	700mA	0.09Ω	25	250MHz	8.0GHz	
LQW15AN6N8G00□	6.8nH ±2%	100MHz	700mA	0.09Ω	25	250MHz	6.0GHz	Kit
LQW15AN6N8H00□	6.8nH ±3%	100MHz	700mA	0.09Ω	25	250MHz	6.0GHz	
LQW15AN6N8J00□	6.8nH ±5%	100MHz	700mA	0.09Ω	25	250MHz	6.0GHz	
LQW15AN7N3G00□	7.3nH ±2%	100MHz	570mA	0.13Ω	25	250MHz	6.0GHz	Kit
LQW15AN7N3H00□	7.3nH ±3%	100MHz	570mA	0.13Ω	25	250MHz	6.0GHz	
LQW15AN7N3J00□	7.3nH ±5%	100MHz	570mA	0.13Ω	25	250MHz	6.0GHz	
LQW15AN7N5G00□	7.5nH ±2%	100MHz	570mA	0.13Ω	25	250MHz	6.0GHz	Kit
LQW15AN7N5H00□	7.5nH ±3%	100MHz	570mA	0.13Ω	25	250MHz	6.0GHz	
LQW15AN7N5J00□	7.5nH ±5%	100MHz	570mA	0.13Ω	25	250MHz	6.0GHz	
LQW15AN8N2G00□	8.2nH ±2%	100MHz	540mA	0.14Ω	25	250MHz	5.5GHz	Kit
LQW15AN8N2H00□	8.2nH ±3%	100MHz	540mA	0.14Ω	25	250MHz	5.5GHz	
LQW15AN8N2J00□	8.2nH ±5%	100MHz	540mA	0.14Ω	25	250MHz	5.5GHz	
LQW15AN8N7G00□	8.7nH ±2%	100MHz	540mA	0.14Ω	25	250MHz	5.5GHz	Kit
LQW15AN8N7H00□	8.7nH ±3%	100MHz	540mA	0.14Ω	25	250MHz	5.5GHz	
LQW15AN8N7J00□	8.7nH ±5%	100MHz	540mA	0.14Ω	25	250MHz	5.5GHz	
LQW15AN9N1G00□	9.1nH ±2%	100MHz	540mA	0.14Ω	25	250MHz	5.5GHz	Kit
LQW15AN9N1H00□	9.1nH ±3%	100MHz	540mA	0.14Ω	25	250MHz	5.5GHz	
LQW15AN9N1J00□	9.1nH ±5%	100MHz	540mA	0.14Ω	25	250MHz	5.5GHz	
LQW15AN9N5G00□	9.5nH ±2%	100MHz	540mA	0.14Ω	25	250MHz	5.5GHz	Kit
LQW15AN9N5H00□	9.5nH ±3%	100MHz	540mA	0.14Ω	25	250MHz	5.5GHz	
LQW15AN9N5J00□	9.5nH ±5%	100MHz	540mA	0.14Ω	25	250MHz	5.5GHz	
LQW15AN10NG00□	10nH ±2%	100MHz	500mA	0.17Ω	25	250MHz	5.5GHz	Kit
LQW15AN10NH00□	10nH ±3%	100MHz	500mA	0.17Ω	25	250MHz	5.5GHz	
LQW15AN10NJ00□	10nH ±5%	100MHz	500mA	0.17Ω	25	250MHz	5.5GHz	
LQW15AN11NG00□	11nH ±2%	100MHz	500mA	0.14Ω	30	250MHz	5.5GHz	Kit
LQW15AN11NH00□	11nH ±3%	100MHz	500mA	0.14Ω	30	250MHz	5.5GHz	
LQW15AN11NJ00□	11nH ±5%	100MHz	500mA	0.14Ω	30	250MHz	5.5GHz	
LQW15AN12NG00□	12nH ±2%	100MHz	500mA	0.14Ω	30	250MHz	5.5GHz	Kit
LQW15AN12NH00□	12nH ±3%	100MHz	500mA	0.14Ω	30	250MHz	5.5GHz	
LQW15AN12NJ00□	12nH ±5%	100MHz	500mA	0.14Ω	30	250MHz	5.5GHz	
LQW15AN13NG00□	13nH ±2%	100MHz	430mA	0.21Ω	25	250MHz	5.0GHz	Kit
LQW15AN13NH00□	13nH ±3%	100MHz	430mA	0.21Ω	25	250MHz	5.0GHz	
LQW15AN13NJ00□	13nH ±5%	100MHz	430mA	0.21Ω	25	250MHz	5.0GHz	
LQW15AN15NG00□	15nH ±2%	100MHz	460mA	0.16Ω	30	250MHz	5.0GHz	Kit
LQW15AN15NH00□	15nH ±3%	100MHz	460mA	0.16Ω	30	250MHz	5.0GHz	
LQW15AN15NJ00□	15nH ±5%	100MHz	460mA	0.16Ω	30	250MHz	5.0GHz	
LQW15AN16NG00□	16nH ±2%	100MHz	370mA	0.24Ω	25	250MHz	4.5GHz	Kit
LQW15AN16NH00□	16nH ±3%	100MHz	370mA	0.24Ω	25	250MHz	4.5GHz	
LQW15AN16NJ00□	16nH ±5%	100MHz	370mA	0.24Ω	25	250MHz	4.5GHz	
LQW15AN18NG00□	18nH ±2%	100MHz	370mA	0.27Ω	25	250MHz	4.5GHz	Kit
LQW15AN18NH00□	18nH ±3%	100MHz	370mA	0.27Ω	25	250MHz	4.5GHz	
LQW15AN18NJ00□	18nH ±5%	100MHz	370mA	0.27Ω	25	250MHz	4.5GHz	
LQW15AN19NG00□	19nH ±2%	100MHz	370mA	0.27Ω	25	250MHz	4.5GHz	Kit

Operating Temperature Range (Self-temperature rise is not included): -55°C~+125°C
For reflow soldering only.

Continued on the following page. 

 Note • Please read rating and  CAUTION (for storage, operating, rating, soldering, mounting and handling) in this catalog to prevent smoking and/or burning, etc.
• This catalog has only typical specifications. Therefore, please approve our product specifications or transact the approval sheet for product specifications before ordering.

Part Number	Inductance	Inductance Test Frequency	Rated Current	Max. of DC Resistance	Q (min.)	Q Test Frequency	Self-Resonance Frequency (min.)	
LQW15AN19NH00□	19nH ±3%	100MHz	370mA	0.27Ω	25	250MHz	4.5GHz	
LQW15AN19NJ00□	19nH ±5%	100MHz	370mA	0.27Ω	25	250MHz	4.5GHz	
LQW15AN20NG00□	20nH ±2%	100MHz	370mA	0.27Ω	25	250MHz	4.0GHz	Kit
LQW15AN20NH00□	20nH ±3%	100MHz	370mA	0.27Ω	25	250MHz	4.0GHz	
LQW15AN20NJ00□	20nH ±5%	100MHz	370mA	0.27Ω	25	250MHz	4.0GHz	
LQW15AN22NG00□	22nH ±2%	100MHz	310mA	0.30Ω	25	250MHz	4.0GHz	Kit
LQW15AN22NH00□	22nH ±3%	100MHz	310mA	0.30Ω	25	250MHz	4.0GHz	
LQW15AN22NJ00□	22nH ±5%	100MHz	310mA	0.30Ω	25	250MHz	4.0GHz	
LQW15AN23NG00□	23nH ±2%	100MHz	310mA	0.30Ω	25	250MHz	3.8GHz	Kit
LQW15AN23NH00□	23nH ±3%	100MHz	310mA	0.30Ω	25	250MHz	3.8GHz	
LQW15AN23NJ00□	23nH ±5%	100MHz	310mA	0.30Ω	25	250MHz	3.8GHz	
LQW15AN24NG00□	24nH ±2%	100MHz	280mA	0.52Ω	25	250MHz	3.5GHz	Kit
LQW15AN24NH00□	24nH ±3%	100MHz	280mA	0.52Ω	25	250MHz	3.5GHz	
LQW15AN24NJ00□	24nH ±5%	100MHz	280mA	0.52Ω	25	250MHz	3.5GHz	
LQW15AN27NG00□	27nH ±2%	100MHz	280mA	0.52Ω	25	250MHz	3.5GHz	Kit
LQW15AN27NH00□	27nH ±3%	100MHz	280mA	0.52Ω	25	250MHz	3.5GHz	
LQW15AN27NJ00□	27nH ±5%	100MHz	280mA	0.52Ω	25	250MHz	3.5GHz	
LQW15AN30NG00□	30nH ±2%	100MHz	270mA	0.58Ω	25	250MHz	3.3GHz	Kit
LQW15AN30NH00□	30nH ±3%	100MHz	270mA	0.58Ω	25	250MHz	3.3GHz	
LQW15AN30NJ00□	30nH ±5%	100MHz	270mA	0.58Ω	25	250MHz	3.3GHz	
LQW15AN33NG00□	33nH ±2%	100MHz	260mA	0.63Ω	25	250MHz	3.2GHz	Kit
LQW15AN33NH00□	33nH ±3%	100MHz	260mA	0.63Ω	25	250MHz	3.2GHz	
LQW15AN33NJ00□	33nH ±5%	100MHz	260mA	0.63Ω	25	250MHz	3.2GHz	
LQW15AN36NG00□	36nH ±2%	100MHz	260mA	0.63Ω	25	250MHz	3.1GHz	Kit
LQW15AN36NH00□	36nH ±3%	100MHz	260mA	0.63Ω	25	250MHz	3.1GHz	
LQW15AN36NJ00□	36nH ±5%	100MHz	260mA	0.63Ω	25	250MHz	3.1GHz	
LQW15AN39NG00□	39nH ±2%	100MHz	250mA	0.70Ω	25	250MHz	3.0GHz	Kit
LQW15AN39NH00□	39nH ±3%	100MHz	250mA	0.70Ω	25	250MHz	3.0GHz	
LQW15AN39NJ00□	39nH ±5%	100MHz	250mA	0.70Ω	25	250MHz	3.0GHz	
LQW15AN40NG00□	40nH ±2%	100MHz	250mA	0.70Ω	25	250MHz	3.0GHz	Kit
LQW15AN40NH00□	40nH ±3%	100MHz	250mA	0.70Ω	25	250MHz	3.0GHz	
LQW15AN40NJ00□	40nH ±5%	100MHz	250mA	0.70Ω	25	250MHz	3.0GHz	
LQW15AN43NG00□	43nH ±2%	100MHz	250mA	0.70Ω	25	250MHz	3.0GHz	Kit
LQW15AN43NH00□	43nH ±3%	100MHz	250mA	0.70Ω	25	250MHz	3.0GHz	
LQW15AN43NJ00□	43nH ±5%	100MHz	250mA	0.70Ω	25	250MHz	3.0GHz	
LQW15AN47NG00□	47nH ±2%	100MHz	210mA	1.08Ω	25	200MHz	2.9GHz	Kit
LQW15AN47NH00□	47nH ±3%	100MHz	210mA	1.08Ω	25	200MHz	2.9GHz	
LQW15AN47NJ00□	47nH ±5%	100MHz	210mA	1.08Ω	25	200MHz	2.9GHz	
LQW15AN51NG00□	51nH ±2%	100MHz	210mA	1.08Ω	25	200MHz	2.85GHz	Kit
LQW15AN51NH00□	51nH ±3%	100MHz	210mA	1.08Ω	25	200MHz	2.85GHz	
LQW15AN51NJ00□	51nH ±5%	100MHz	210mA	1.08Ω	25	200MHz	2.85GHz	
LQW15AN56NG00□	56nH ±2%	100MHz	200mA	1.17Ω	25	200MHz	2.8GHz	Kit
LQW15AN56NH00□	56nH ±3%	100MHz	200mA	1.17Ω	25	200MHz	2.8GHz	
LQW15AN56NJ00□	56nH ±5%	100MHz	200mA	1.17Ω	25	200MHz	2.8GHz	
LQW15AN62NG00□	62nH ±2%	100MHz	145mA	1.82Ω	20	200MHz	2.6GHz	Kit
LQW15AN62NH00□	62nH ±3%	100MHz	145mA	1.82Ω	20	200MHz	2.6GHz	
LQW15AN62NJ00□	62nH ±5%	100MHz	145mA	1.82Ω	20	200MHz	2.6GHz	

Operating Temperature Range (Self-temperature rise is not included): -55°C~+125°C
For reflow soldering only.

Continued on the following page. 

△Note • Please read rating and △CAUTION (for storage, operating, rating, soldering, mounting and handling) in this catalog to prevent smoking and/or burning, etc.
• This catalog has only typical specifications. Therefore, please approve our product specifications or transact the approval sheet for product specifications before ordering.

O05E.pdf
Nov.25,2013

Part Number	Inductance	Inductance Test Frequency	Rated Current	Max. of DC Resistance	Q (min.)	Q Test Frequency	Self-Resonance Frequency (min.)	
LQW15AN68NG00□	68nH ±2%	100MHz	140mA	1.96Ω	20	200MHz	2.5GHz	Kit
LQW15AN68NJ00□	68nH ±5%	100MHz	140mA	1.96Ω	20	200MHz	2.5GHz	
LQW15AN72NG00□	72nH ±2%	100MHz	135mA	2.10Ω	20	150MHz	2.5GHz	Kit
LQW15AN72NJ00□	72nH ±5%	100MHz	135mA	2.10Ω	20	150MHz	2.5GHz	
LQW15AN75NG00□	75nH ±2%	100MHz	135mA	2.10Ω	20	150MHz	2.4GHz	Kit
LQW15AN75NJ00□	75nH ±5%	100MHz	135mA	2.10Ω	20	150MHz	2.4GHz	
LQW15AN82NG00□	82nH ±2%	100MHz	130mA	2.24Ω	20	150MHz	2.3GHz	Kit
LQW15AN82NJ00□	82nH ±5%	100MHz	130mA	2.24Ω	20	150MHz	2.3GHz	
LQW15AN91NG00□	91nH ±2%	100MHz	125mA	2.38Ω	20	150MHz	2.1GHz	Kit
LQW15AN91NJ00□	91nH ±5%	100MHz	125mA	2.38Ω	20	150MHz	2.1GHz	
LQW15ANR10J00□	100nH ±5%	100MHz	120mA	2.52Ω	20	150MHz	1.5GHz	Kit
LQW15ANR12J00□	120nH ±5%	100MHz	110mA	2.66Ω	20	150MHz	1.0GHz	Kit

Operating Temperature Range (Self-temperature rise is not included): -55°C~+125°C
For reflow soldering only.

■ Q-Frequency Characteristics (Typ.)

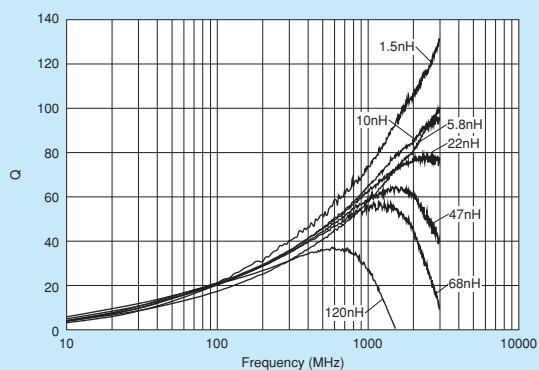

■ Inductance-Frequency Characteristics (Typ.)

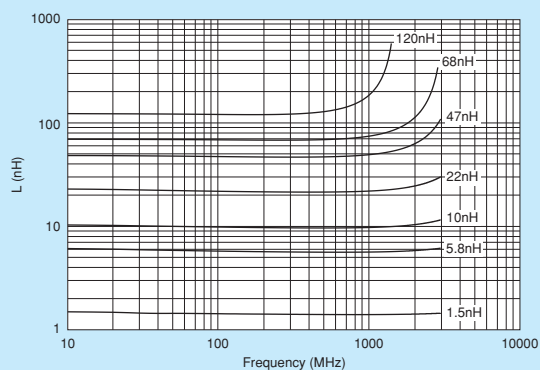

Continued on the following page.

△Note • Please read rating and △CAUTION (for storage, operating, rating, soldering, mounting and handling) in this catalog to prevent smoking and/or burning, etc.
• This catalog has only typical specifications. Therefore, please approve our product specifications or transact the approval sheet for product specifications before ordering.

Reference Data

LQW15AN_00

4991A&16197A

Part Number	Inductance (nH)	Q (Typ.)				
	Nominal	800MHz	900MHz	1.8GHz	2.0GHz	2.4GHz
LQW15AN1N5	1.5	55	60	90	100	115
LQW15AN2N4	2.4	65	67	98	108	120
LQW15AN2N5	2.5	65	67	90	100	110
LQW15AN2N7	2.7	67	73	100	105	120
LQW15AN2N9	2.9	53	58	80	85	92
LQW15AN3N9	3.9	58	61	88	92	100
LQW15AN4N1	4.1	58	61	88	92	100
LQW15AN4N3	4.3	58	61	88	92	100
LQW15AN4N7	4.7	65	67	88	92	95
LQW15AN5N1	5.1	60	65	85	90	95
LQW15AN5N8	5.8	63	67	88	92	105
LQW15AN6N2	6.2	63	65	90	95	105
LQW15AN6N8	6.8	70	72	96	100	103
LQW15AN7N3	7.3	58	63	88	90	92
LQW15AN7N5	7.5	58	63	88	90	92
LQW15AN8N2	8.2	62	67	90	95	102
LQW15AN8N7	8.7	60	62	85	90	92
LQW15AN9N1	9.1	62	68	90	92	95
LQW15AN9N5	9.5	62	68	90	92	95
LQW15AN10N	10	60	65	82	85	84
LQW15AN11N	11	65	70	105	110	120
LQW15AN12N	12	60	62	85	90	91
LQW15AN13N	13	60	62	72	71	67
LQW15AN15N	15	60	65	85	88	90
LQW15AN16N	16	60	63	90	100	110
LQW15AN18N	18	63	65	88	87	85
LQW15AN19N	19	57	62	80	82	83
LQW15AN20N	20	57	62	80	82	83
LQW15AN22N	22	55	58	75	78	-
LQW15AN23N	23	55	58	75	78	-
LQW15AN24N	24	50	50	42	-	-
LQW15AN27N	27	55	56	58	-	-
LQW15AN30N	30	55	58	68	-	-
LQW15AN33N	33	55	56	53	-	-
LQW15AN36N	36	52	52	42	-	-
LQW15AN39N	39	55	56	-	-	-
LQW15AN40N	40	55	56	-	-	-
LQW15AN43N	43	55	56	-	-	-
LQW15AN47N	47	52	54	-	-	-
LQW15AN51N	51	52	54	-	-	-
LQW15AN56N	56	53	55	-	-	-
LQW15AN62N	62	51	52	-	-	-
LQW15AN68N	68	49	52	-	-	-
LQW15AN72N	72	49	52	-	-	-
LQW15AN75N	75	49	52	-	-	-
LQW15AN82N	82	49	50	-	-	-
LQW15AN91N	91	52	53	-	-	-
LQW15ANR10	100	43	43	-	-	-
LQW15ANR12	120	30	23	-	-	-

△Note • Please read rating and △CAUTION (for storage, operating, rating, soldering, mounting and handling) in this catalog to prevent smoking and/or burning, etc.
 • This catalog has only typical specifications. Therefore, please approve our product specifications or transact the approval sheet for product specifications before ordering.

LQW15AN_10 Series 0402/1005 (inch/mm)

Size Code 0402 (1005) in inch (in mm), High Q, Low DC Resistance Type

■ Appearance/Dimensions

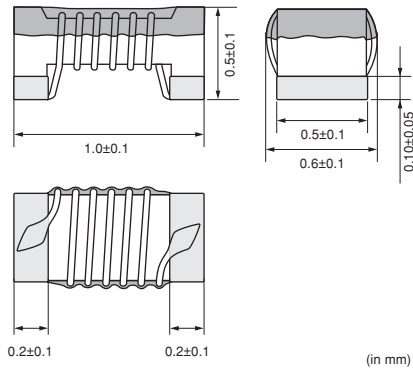

■ Packaging

Code	Packaging	Minimum Quantity
D	ø180mm Paper Taping	10000
B	Packing in Bulk	500



Refer to pages 227 to 230 for mounting information.

■ Rated Value (□: packaging code)

Part Number	Inductance	Inductance Test Frequency	Rated Current	Max. of DC Resistance	Q (min.)	Q Test Frequency	Self-Resonance Frequency (min.)	
LQW15AN1N3C10□	1.3nH ±0.2nH	100MHz	1200mA	0.017Ω	20	250MHz	16.0GHz	Kit
LQW15AN1N3D10□	1.3nH ±0.5nH	100MHz	1200mA	0.017Ω	20	250MHz	16.0GHz	
LQW15AN2N2C10□	2.2nH ±0.2nH	100MHz	1000mA	0.027Ω	25	250MHz	14.0GHz	Kit
LQW15AN2N2D10□	2.2nH ±0.5nH	100MHz	1000mA	0.027Ω	25	250MHz	14.0GHz	
LQW15AN2N4D10□	2.4nH ±0.5nH	100MHz	1000mA	0.027Ω	25	250MHz	14.0GHz	Kit
LQW15AN3N3D10□	3.3nH ±0.5nH	100MHz	900mA	0.040Ω	30	250MHz	12.0GHz	Kit
LQW15AN3N4C10□	3.4nH ±0.2nH	100MHz	900mA	0.040Ω	30	250MHz	12.0GHz	Kit
LQW15AN3N4D10□	3.4nH ±0.5nH	100MHz	900mA	0.040Ω	30	250MHz	12.0GHz	
LQW15AN3N6C10□	3.6nH ±0.2nH	100MHz	900mA	0.040Ω	30	250MHz	9.5GHz	Kit
LQW15AN3N6D10□	3.6nH ±0.5nH	100MHz	900mA	0.040Ω	30	250MHz	9.5GHz	
LQW15AN3N9D10□	3.9nH ±0.5nH	100MHz	900mA	0.040Ω	30	250MHz	7.0GHz	Kit
LQW15AN4N7D10□	4.7nH ±0.5nH	100MHz	800mA	0.051Ω	30	250MHz	8.0GHz	Kit
LQW15AN5N1C10□	5.1nH ±0.2nH	100MHz	800mA	0.051Ω	30	250MHz	8.0GHz	Kit
LQW15AN5N1D10□	5.1nH ±0.5nH	100MHz	800mA	0.051Ω	30	250MHz	8.0GHz	
LQW15AN5N6C10□	5.6nH ±0.2nH	100MHz	800mA	0.051Ω	30	250MHz	8.0GHz	Kit
LQW15AN5N6D10□	5.6nH ±0.5nH	100MHz	800mA	0.051Ω	30	250MHz	8.0GHz	

Operating Temperature Range (Self-temperature rise is not included): -55°C~+125°C
For reflow soldering only.

■ Q-Frequency Characteristics (Typ.)

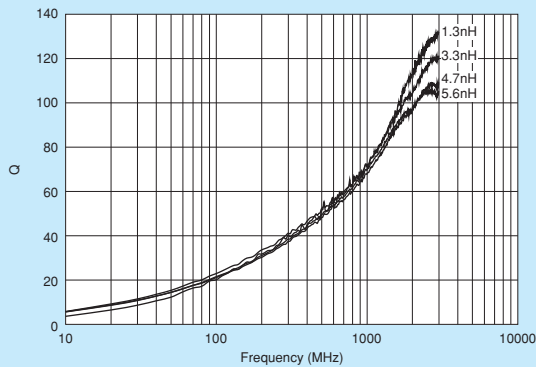

■ Inductance-Frequency Characteristics (Typ.)

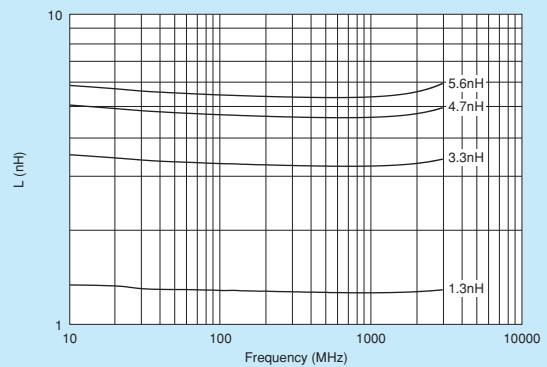

Continued on the following page.

△Note • Please read rating and △CAUTION (for storage, operating, rating, soldering, mounting and handling) in this catalog to prevent smoking and/or burning, etc.
• This catalog has only typical specifications. Therefore, please approve our product specifications or transact the approval sheet for product specifications before ordering.

■ Reference Data

LQW15AN_10

4991A&16197A

Part Number	Inductance (nH)	Q (Typ.)				
	Nominal	800MHz	900MHz	1.8GHz	2.0GHz	2.4GHz
LQW15AN1N3	1.3	90	95	145	160	180
LQW15AN2N2	2.2	85	90	130	140	160
LQW15AN2N4	2.4	80	85	130	140	160
LQW15AN3N3	3.3	80	85	120	128	140
LQW15AN3N4	3.4	80	85	120	128	140
LQW15AN3N6	3.6	73	75	110	115	130
LQW15AN3N9	3.9	75	80	110	115	120
LQW15AN4N7	4.7	75	80	113	120	132
LQW15AN5N1	5.1	75	80	110	115	128
LQW15AN5N6	5.6	70	75	100	105	110

△Note • Please read rating and △CAUTION (for storage, operating, rating, soldering, mounting and handling) in this catalog to prevent smoking and/or burning, etc.
 • This catalog has only typical specifications. Therefore, please approve our product specifications or transact the approval sheet for product specifications before ordering.

LQW15AN_80 Series 0402/1005 (inch/mm)

Size Code 0402 (1005) in inch (in mm), Wound Type

■ Appearance/Dimensions

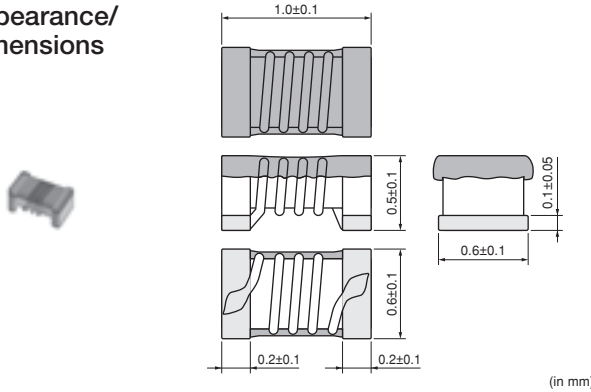

■ Packaging

Code	Packaging	Minimum Quantity
D	ø180mm Paper Taping	10000
B	Packing in Bulk	500



Refer to pages 227 to 230 for mounting information.

■ Rated Value (□: packaging code)

Part Number	Inductance	Inductance Test Frequency	Rated Current	Max. of DC Resistance	Q (min.)	Q Test Frequency	Self-Resonance Frequency (min.)	
LQW15AN1N3C80□	1.3nH ±0.2nH	100MHz	3150mA	0.012Ω	20	250MHz	18.0GHz	Kit
LQW15AN1N3D80□	1.3nH ±0.5nH	100MHz	3150mA	0.012Ω	20	250MHz	18.0GHz	
LQW15AN1N5C80□	1.5nH ±0.2nH	100MHz	2100mA	0.028Ω	20	250MHz	18.0GHz	New
LQW15AN1N5D80□	1.5nH ±0.5nH	100MHz	2100mA	0.028Ω	20	250MHz	18.0GHz	New
LQW15AN1N6C80□	1.6nH ±0.2nH	100MHz	1450mA	0.045Ω	20	250MHz	18.0GHz	New
LQW15AN1N6D80□	1.6nH ±0.5nH	100MHz	1450mA	0.045Ω	20	250MHz	18.0GHz	New
LQW15AN1N7C80□	1.7nH ±0.2nH	100MHz	1150mA	0.065Ω	20	250MHz	18.0GHz	New
LQW15AN1N7D80□	1.7nH ±0.5nH	100MHz	1150mA	0.065Ω	20	250MHz	18.0GHz	New
LQW15AN2N2B80□	2.2nH ±0.1nH	100MHz	2530mA	0.022Ω	30	250MHz	15.5GHz	New
LQW15AN2N2C80□	2.2nH ±0.2nH	100MHz	2530mA	0.022Ω	30	250MHz	15.5GHz	New
LQW15AN2N2D80□	2.2nH ±0.5nH	100MHz	2530mA	0.022Ω	30	250MHz	15.5GHz	New
LQW15AN2N3B80□	2.3nH ±0.1nH	100MHz	2530mA	0.022Ω	30	250MHz	15.5GHz	Kit
LQW15AN2N3C80□	2.3nH ±0.2nH	100MHz	2530mA	0.022Ω	30	250MHz	15.5GHz	
LQW15AN2N3D80□	2.3nH ±0.5nH	100MHz	2530mA	0.022Ω	30	250MHz	15.5GHz	
LQW15AN2N4B80□	2.4nH ±0.1nH	100MHz	2530mA	0.022Ω	30	250MHz	15.5GHz	Kit
LQW15AN2N4C80□	2.4nH ±0.2nH	100MHz	2530mA	0.022Ω	30	250MHz	15.5GHz	
LQW15AN2N4D80□	2.4nH ±0.5nH	100MHz	2530mA	0.022Ω	30	250MHz	15.5GHz	
LQW15AN2N5B80□	2.5nH ±0.1nH	100MHz	2100mA	0.030Ω	30	250MHz	15.5GHz	New
LQW15AN2N5C80□	2.5nH ±0.2nH	100MHz	2100mA	0.030Ω	30	250MHz	15.5GHz	New
LQW15AN2N5D80□	2.5nH ±0.5nH	100MHz	2100mA	0.030Ω	30	250MHz	15.5GHz	New
LQW15AN2N6B80□	2.6nH ±0.1nH	100MHz	1950mA	0.035Ω	30	250MHz	14.5GHz	New
LQW15AN2N6C80□	2.6nH ±0.2nH	100MHz	1950mA	0.035Ω	30	250MHz	14.5GHz	New
LQW15AN2N6D80□	2.6nH ±0.5nH	100MHz	1950mA	0.035Ω	30	250MHz	14.5GHz	New
LQW15AN2N7B80□	2.7nH ±0.1nH	100MHz	1500mA	0.047Ω	28	250MHz	14.0GHz	New
LQW15AN2N7C80□	2.7nH ±0.2nH	100MHz	1500mA	0.047Ω	28	250MHz	14.0GHz	New
LQW15AN2N7D80□	2.7nH ±0.5nH	100MHz	1500mA	0.047Ω	28	250MHz	14.0GHz	New
LQW15AN2N8B80□	2.8nH ±0.1nH	100MHz	1500mA	0.047Ω	27	250MHz	13.5GHz	New
LQW15AN2N8C80□	2.8nH ±0.2nH	100MHz	1500mA	0.047Ω	27	250MHz	13.5GHz	New
LQW15AN2N8D80□	2.8nH ±0.5nH	100MHz	1500mA	0.047Ω	27	250MHz	13.5GHz	New
LQW15AN2N9B80□	2.9nH ±0.1nH	100MHz	1500mA	0.047Ω	25	250MHz	12.5GHz	New
LQW15AN2N9C80□	2.9nH ±0.2nH	100MHz	1500mA	0.047Ω	25	250MHz	12.5GHz	New
LQW15AN2N9D80□	2.9nH ±0.5nH	100MHz	1500mA	0.047Ω	25	250MHz	12.5GHz	New
LQW15AN3N0B80□	3nH ±0.1nH	100MHz	1350mA	0.063Ω	20	250MHz	12.5GHz	New

Operating Temperature Range (Self-temperature rise is not included): -55°C~+125°C
For reflow soldering only.



Continued on the following page.

△Note • Please read rating and △CAUTION (for storage, operating, rating, soldering, mounting and handling) in this catalog to prevent smoking and/or burning, etc.
• This catalog has only typical specifications. Therefore, please approve our product specifications or transact the approval sheet for product specifications before ordering.

Part Number	Inductance	Inductance Test Frequency	Rated Current	Max. of DC Resistance	Q (min.)	Q Test Frequency	Self-Resonance Frequency (min.)	
LQW15AN3N0C80	3nH ±0.2nH	100MHz	1350mA	0.063Ω	20	250MHz	12.5GHz	New
LQW15AN3N0D80	3nH ±0.5nH	100MHz	1350mA	0.063Ω	20	250MHz	12.5GHz	New
LQW15AN3N3B80	3.3nH ±0.1nH	100MHz	2000mA	0.030Ω	30	250MHz	14.0GHz	New
LQW15AN3N3C80	3.3nH ±0.2nH	100MHz	2000mA	0.030Ω	30	250MHz	14.0GHz	New
LQW15AN3N3D80	3.3nH ±0.5nH	100MHz	2000mA	0.030Ω	30	250MHz	14.0GHz	New
LQW15AN3N4B80	3.4nH ±0.1nH	100MHz	1950mA	0.030Ω	30	250MHz	10.0GHz	Kit
LQW15AN3N4C80	3.4nH ±0.2nH	100MHz	1950mA	0.030Ω	30	250MHz	10.0GHz	
LQW15AN3N4D80	3.4nH ±0.5nH	100MHz	1950mA	0.030Ω	30	250MHz	10.0GHz	
LQW15AN3N5B80	3.5nH ±0.1nH	100MHz	1950mA	0.030Ω	30	250MHz	10.0GHz	New
LQW15AN3N5C80	3.5nH ±0.2nH	100MHz	1950mA	0.030Ω	30	250MHz	10.0GHz	New
LQW15AN3N5D80	3.5nH ±0.5nH	100MHz	1950mA	0.030Ω	30	250MHz	10.0GHz	New
LQW15AN3N6B80	3.6nH ±0.1nH	100MHz	1950mA	0.030Ω	30	250MHz	10.0GHz	Kit
LQW15AN3N6C80	3.6nH ±0.2nH	100MHz	1950mA	0.030Ω	30	250MHz	10.0GHz	
LQW15AN3N6D80	3.6nH ±0.5nH	100MHz	1950mA	0.030Ω	30	250MHz	10.0GHz	
LQW15AN3N7B80	3.7nH ±0.1nH	100MHz	1950mA	0.030Ω	35	250MHz	10.0GHz	New
LQW15AN3N7C80	3.7nH ±0.2nH	100MHz	1950mA	0.030Ω	35	250MHz	10.0GHz	New
LQW15AN3N7D80	3.7nH ±0.5nH	100MHz	1950mA	0.030Ω	35	250MHz	10.0GHz	New
LQW15AN3N8B80	3.8nH ±0.1nH	100MHz	1950mA	0.030Ω	35	250MHz	10.0GHz	Kit
LQW15AN3N8C80	3.8nH ±0.2nH	100MHz	1950mA	0.030Ω	35	250MHz	10.0GHz	
LQW15AN3N8D80	3.8nH ±0.5nH	100MHz	1950mA	0.030Ω	35	250MHz	10.0GHz	
LQW15AN3N9B80	3.9nH ±0.1nH	100MHz	1950mA	0.030Ω	35	250MHz	10.0GHz	Kit
LQW15AN3N9C80	3.9nH ±0.2nH	100MHz	1950mA	0.030Ω	35	250MHz	10.0GHz	
LQW15AN3N9D80	3.9nH ±0.5nH	100MHz	1950mA	0.030Ω	35	250MHz	10.0GHz	
LQW15AN4N0B80	4.0nH ±0.1nH	100MHz	1950mA	0.030Ω	30	250MHz	10.0GHz	Kit
LQW15AN4N0C80	4.0nH ±0.2nH	100MHz	1950mA	0.030Ω	30	250MHz	10.0GHz	
LQW15AN4N0D80	4.0nH ±0.5nH	100MHz	1950mA	0.030Ω	30	250MHz	10.0GHz	
LQW15AN4N1B80	4.1nH ±0.1nH	100MHz	1800mA	0.044Ω	30	250MHz	9.6GHz	New
LQW15AN4N1C80	4.1nH ±0.2nH	100MHz	1800mA	0.044Ω	30	250MHz	9.6GHz	New
LQW15AN4N1D80	4.1nH ±0.5nH	100MHz	1800mA	0.044Ω	30	250MHz	9.6GHz	New
LQW15AN4N2B80	4.2nH ±0.1nH	100MHz	1800mA	0.044Ω	30	250MHz	9.6GHz	New
LQW15AN4N2C80	4.2nH ±0.2nH	100MHz	1800mA	0.044Ω	30	250MHz	9.6GHz	New
LQW15AN4N2D80	4.2nH ±0.5nH	100MHz	1800mA	0.044Ω	30	250MHz	9.6GHz	New
LQW15AN4N3B80	4.3nH ±0.1nH	100MHz	1800mA	0.044Ω	32	250MHz	9.6GHz	New
LQW15AN4N3C80	4.3nH ±0.2nH	100MHz	1800mA	0.044Ω	32	250MHz	9.6GHz	New
LQW15AN4N3D80	4.3nH ±0.5nH	100MHz	1800mA	0.044Ω	32	250MHz	9.6GHz	New
LQW15AN4N4B80	4.4nH ±0.1nH	100MHz	1600mA	0.052Ω	34	250MHz	9.6GHz	New
LQW15AN4N4C80	4.4nH ±0.2nH	100MHz	1600mA	0.052Ω	34	250MHz	9.6GHz	New
LQW15AN4N4D80	4.4nH ±0.5nH	100MHz	1600mA	0.052Ω	34	250MHz	9.6GHz	New
LQW15AN4N5B80	4.5nH ±0.1nH	100MHz	1450mA	0.060Ω	34	250MHz	9.6GHz	New
LQW15AN4N5C80	4.5nH ±0.2nH	100MHz	1450mA	0.060Ω	34	250MHz	9.6GHz	New
LQW15AN4N5D80	4.5nH ±0.5nH	100MHz	1450mA	0.060Ω	34	250MHz	9.6GHz	New
LQW15AN4N6B80	4.6nH ±0.1nH	100MHz	1450mA	0.060Ω	32	250MHz	9.6GHz	New
LQW15AN4N6C80	4.6nH ±0.2nH	100MHz	1450mA	0.060Ω	32	250MHz	9.6GHz	New
LQW15AN4N6D80	4.6nH ±0.5nH	100MHz	1450mA	0.060Ω	32	250MHz	9.6GHz	New
LQW15AN4N7B80	4.7nH ±0.1nH	100MHz	1200mA	0.071Ω	31	250MHz	8.0GHz	New
LQW15AN4N7C80	4.7nH ±0.2nH	100MHz	1200mA	0.071Ω	31	250MHz	8.0GHz	New
LQW15AN4N7D80	4.7nH ±0.5nH	100MHz	1200mA	0.071Ω	31	250MHz	8.0GHz	New
LQW15AN4N8B80	4.8nH ±0.1nH	100MHz	1200mA	0.071Ω	30	250MHz	8.0GHz	New

Operating Temperature Range (Self-temperature rise is not included): -55°C~+125°C
For reflow soldering only.



Continued on the following page. 

 Note • Please read rating and  CAUTION (for storage, operating, rating, soldering, mounting and handling) in this catalog to prevent smoking and/or burning, etc.
• This catalog has only typical specifications. Therefore, please approve our product specifications or transact the approval sheet for product specifications before ordering.

Part Number	Inductance	Inductance Test Frequency	Rated Current	Max. of DC Resistance	Q (min.)	Q Test Frequency	Self-Resonance Frequency (min.)	
LQW15AN4N8C80	4.8nH ±0.2nH	100MHz	1200mA	0.071 Ω	30	250MHz	8.0GHz	New
LQW15AN4N8D80	4.8nH ±0.5nH	100MHz	1200mA	0.071 Ω	30	250MHz	8.0GHz	New
LQW15AN4N9B80	4.9nH ±0.1nH	100MHz	1200mA	0.071 Ω	27	250MHz	8.0GHz	New
LQW15AN4N9C80	4.9nH ±0.2nH	100MHz	1200mA	0.071 Ω	27	250MHz	8.0GHz	New
LQW15AN4N9D80	4.9nH ±0.5nH	100MHz	1200mA	0.071 Ω	27	250MHz	8.0GHz	New
LQW15AN5N0B80	5.0nH ±0.1nH	100MHz	1770mA	0.040 Ω	32	250MHz	10.0GHz	New
LQW15AN5N0C80	5.0nH ±0.2nH	100MHz	1770mA	0.040 Ω	32	250MHz	10.0GHz	New
LQW15AN5N0D80	5.0nH ±0.5nH	100MHz	1770mA	0.040 Ω	32	250MHz	10.0GHz	New
LQW15AN5N1B80	5.1nH ±0.1nH	100MHz	1770mA	0.040 Ω	35	250MHz	8.0GHz	Kit
LQW15AN5N1C80	5.1nH ±0.2nH	100MHz	1770mA	0.040 Ω	35	250MHz	8.0GHz	
LQW15AN5N1D80	5.1nH ±0.5nH	100MHz	1770mA	0.040 Ω	35	250MHz	8.0GHz	
LQW15AN5N2B80	5.2nH ±0.1nH	100MHz	1770mA	0.040 Ω	35	250MHz	8.0GHz	Kit
LQW15AN5N2C80	5.2nH ±0.2nH	100MHz	1770mA	0.040 Ω	35	250MHz	8.0GHz	
LQW15AN5N2D80	5.2nH ±0.5nH	100MHz	1770mA	0.040 Ω	35	250MHz	8.0GHz	
LQW15AN5N3B80	5.3nH ±0.1nH	100MHz	1770mA	0.040 Ω	35	250MHz	8.0GHz	New
LQW15AN5N3C80	5.3nH ±0.2nH	100MHz	1770mA	0.040 Ω	35	250MHz	8.0GHz	New
LQW15AN5N3D80	5.3nH ±0.5nH	100MHz	1770mA	0.040 Ω	35	250MHz	8.0GHz	New
LQW15AN5N4B80	5.4nH ±0.1nH	100MHz	1770mA	0.040 Ω	35	250MHz	8.0GHz	Kit
LQW15AN5N4C80	5.4nH ±0.2nH	100MHz	1770mA	0.040 Ω	35	250MHz	8.0GHz	
LQW15AN5N4D80	5.4nH ±0.5nH	100MHz	1770mA	0.040 Ω	35	250MHz	8.0GHz	
LQW15AN5N5B80	5.5nH ±0.1nH	100MHz	1770mA	0.040 Ω	35	250MHz	8.0GHz	New
LQW15AN5N5C80	5.5nH ±0.2nH	100MHz	1770mA	0.040 Ω	35	250MHz	8.0GHz	New
LQW15AN5N5D80	5.5nH ±0.5nH	100MHz	1770mA	0.040 Ω	35	250MHz	8.0GHz	New
LQW15AN5N6B80	5.6nH ±0.1nH	100MHz	1770mA	0.040 Ω	35	250MHz	8.0GHz	Kit
LQW15AN5N6C80	5.6nH ±0.2nH	100MHz	1770mA	0.040 Ω	35	250MHz	8.0GHz	
LQW15AN5N6D80	5.6nH ±0.5nH	100MHz	1770mA	0.040 Ω	35	250MHz	8.0GHz	
LQW15AN5N7B80	5.7nH ±0.1nH	100MHz	1770mA	0.040 Ω	30	250MHz	8.0GHz	Kit
LQW15AN5N7C80	5.7nH ±0.2nH	100MHz	1770mA	0.040 Ω	30	250MHz	8.0GHz	
LQW15AN5N7D80	5.7nH ±0.5nH	100MHz	1770mA	0.040 Ω	30	250MHz	8.0GHz	
LQW15AN5N8B80	5.8nH ±0.1nH	100MHz	1770mA	0.040 Ω	30	250MHz	8.0GHz	Kit
LQW15AN5N8C80	5.8nH ±0.2nH	100MHz	1770mA	0.040 Ω	30	250MHz	8.0GHz	
LQW15AN5N8D80	5.8nH ±0.5nH	100MHz	1770mA	0.040 Ω	30	250MHz	8.0GHz	
LQW15AN5N9B80	5.9nH ±0.1nH	100MHz	1770mA	0.040 Ω	30	250MHz	8.0GHz	New
LQW15AN5N9C80	5.9nH ±0.2nH	100MHz	1770mA	0.040 Ω	30	250MHz	8.0GHz	New
LQW15AN5N9D80	5.9nH ±0.5nH	100MHz	1770mA	0.040 Ω	30	250MHz	8.0GHz	New
LQW15AN6N0B80	6.0nH ±0.1nH	100MHz	1600mA	0.056 Ω	32	250MHz	8.0GHz	New
LQW15AN6N0C80	6.0nH ±0.2nH	100MHz	1600mA	0.056 Ω	32	250MHz	8.0GHz	New
LQW15AN6N0D80	6.0nH ±0.5nH	100MHz	1600mA	0.056 Ω	32	250MHz	8.0GHz	New
LQW15AN6N1B80	6.1nH ±0.1nH	100MHz	1600mA	0.056 Ω	32	250MHz	8.0GHz	New
LQW15AN6N1C80	6.1nH ±0.2nH	100MHz	1600mA	0.056 Ω	32	250MHz	8.0GHz	New
LQW15AN6N1D80	6.1nH ±0.5nH	100MHz	1600mA	0.056 Ω	32	250MHz	8.0GHz	New
LQW15AN6N2B80	6.2nH ±0.1nH	100MHz	1600mA	0.056 Ω	33	250MHz	8.0GHz	New
LQW15AN6N2C80	6.2nH ±0.2nH	100MHz	1600mA	0.056 Ω	33	250MHz	8.0GHz	New
LQW15AN6N2D80	6.2nH ±0.5nH	100MHz	1600mA	0.056 Ω	33	250MHz	8.0GHz	New
LQW15AN6N3G80	6.3nH ±2%	100MHz	1600mA	0.057 Ω	32	250MHz	7.8GHz	New
LQW15AN6N3J80	6.3nH ±5%	100MHz	1600mA	0.057 Ω	32	250MHz	7.8GHz	New
LQW15AN6N4G80	6.4nH ±2%	100MHz	1380mA	0.065 Ω	33	250MHz	7.0GHz	New
LQW15AN6N4J80	6.4nH ±5%	100MHz	1380mA	0.065 Ω	33	250MHz	7.0GHz	New

Operating Temperature Range (Self-temperature rise is not included): -55°C~+125°C
For reflow soldering only.

Continued on the following page. 

 Note • Please read rating and  CAUTION (for storage, operating, rating, soldering, mounting and handling) in this catalog to prevent smoking and/or burning, etc.
• This catalog has only typical specifications. Therefore, please approve our product specifications or transact the approval sheet for product specifications before ordering.

Part Number	Inductance	Inductance Test Frequency	Rated Current	Max. of DC Resistance	Q (min.)	Q Test Frequency	Self-Resonance Frequency (min.)	
LQW15AN6N5G80□	6.5nH ±2%	100MHz	1380mA	0.065Ω	32	250MHz	7.0GHz	New
LQW15AN6N5J80□	6.5nH ±5%	100MHz	1380mA	0.065Ω	32	250MHz	7.0GHz	New
LQW15AN6N6G80□	6.6nH ±2%	100MHz	1280mA	0.078Ω	30	250MHz	7.0GHz	New
LQW15AN6N6J80□	6.6nH ±5%	100MHz	1280mA	0.078Ω	30	250MHz	7.0GHz	New
LQW15AN6N7G80□	6.7nH ±2%	100MHz	1280mA	0.078Ω	30	250MHz	7.0GHz	New
LQW15AN6N7J80□	6.7nH ±5%	100MHz	1280mA	0.078Ω	30	250MHz	7.0GHz	New
LQW15AN6N8G80□	6.8nH ±2%	100MHz	1450mA	0.068Ω	30	250MHz	7.0GHz	New
LQW15AN6N8J80□	6.8nH ±5%	100MHz	1450mA	0.068Ω	30	250MHz	7.0GHz	New
LQW15AN6N9G80□	6.9nH ±2%	100MHz	1420mA	0.069Ω	32	250MHz	8.5GHz	New
LQW15AN6N9J80□	6.9nH ±5%	100MHz	1420mA	0.069Ω	32	250MHz	8.5GHz	New
LQW15AN7N0G80□	7.0nH ±2%	100MHz	1420mA	0.069Ω	33	250MHz	8.0GHz	New
LQW15AN7N0J80□	7.0nH ±5%	100MHz	1420mA	0.069Ω	33	250MHz	8.0GHz	New
LQW15AN7N1G80□	7.1nH ±2%	100MHz	1420mA	0.069Ω	32	250MHz	7.0GHz	New
LQW15AN7N1J80□	7.1nH ±5%	100MHz	1420mA	0.069Ω	32	250MHz	7.0GHz	New
LQW15AN7N2G80□	7.2nH ±2%	100MHz	1700mA	0.050Ω	32	250MHz	7.0GHz	New
LQW15AN7N2J80□	7.2nH ±5%	100MHz	1700mA	0.050Ω	32	250MHz	7.0GHz	New
LQW15AN7N3G80□	7.3nH ±2%	100MHz	1700mA	0.050Ω	32	250MHz	7.0GHz	New
LQW15AN7N3J80□	7.3nH ±5%	100MHz	1700mA	0.050Ω	32	250MHz	7.0GHz	New
LQW15AN7N4G80□	7.4nH ±2%	100MHz	1700mA	0.050Ω	30	250MHz	7.0GHz	Kit
LQW15AN7N4J80□	7.4nH ±5%	100MHz	1700mA	0.050Ω	30	250MHz	7.0GHz	
LQW15AN7N5G80□	7.5nH ±2%	100MHz	1700mA	0.050Ω	35	250MHz	7.0GHz	Kit
LQW15AN7N5J80□	7.5nH ±5%	100MHz	1700mA	0.050Ω	35	250MHz	7.0GHz	
LQW15AN7N6G80□	7.6nH ±2%	100MHz	1700mA	0.050Ω	30	250MHz	7.0GHz	Kit
LQW15AN7N6J80□	7.6nH ±5%	100MHz	1700mA	0.050Ω	30	250MHz	7.0GHz	
LQW15AN7N7G80□	7.7nH ±2%	100MHz	1700mA	0.050Ω	30	250MHz	7.0GHz	Kit
LQW15AN7N7J80□	7.7nH ±5%	100MHz	1700mA	0.050Ω	30	250MHz	7.0GHz	
LQW15AN7N8G80□	7.8nH ±2%	100MHz	1700mA	0.050Ω	30	250MHz	7.0GHz	Kit
LQW15AN7N8J80□	7.8nH ±5%	100MHz	1700mA	0.050Ω	30	250MHz	7.0GHz	
LQW15AN7N9G80□	7.9nH ±2%	100MHz	1700mA	0.050Ω	30	250MHz	7.0GHz	New
LQW15AN7N9J80□	7.9nH ±5%	100MHz	1700mA	0.050Ω	30	250MHz	7.0GHz	New
LQW15AN8N0G80□	8.0nH ±2%	100MHz	1700mA	0.050Ω	30	250MHz	7.0GHz	Kit
LQW15AN8N0J80□	8.0nH ±5%	100MHz	1700mA	0.050Ω	30	250MHz	7.0GHz	
LQW15AN8N1G80□	8.1nH ±2%	100MHz	1500mA	0.069Ω	32	250MHz	6.5GHz	New
LQW15AN8N1J80□	8.1nH ±5%	100MHz	1500mA	0.069Ω	32	250MHz	6.5GHz	New
LQW15AN8N2G80□	8.2nH ±2%	100MHz	1500mA	0.069Ω	32	250MHz	6.5GHz	New
LQW15AN8N2J80□	8.2nH ±5%	100MHz	1500mA	0.069Ω	32	250MHz	6.5GHz	New
LQW15AN8N3G80□	8.3nH ±2%	100MHz	1500mA	0.069Ω	32	250MHz	6.5GHz	New
LQW15AN8N3J80□	8.3nH ±5%	100MHz	1500mA	0.069Ω	32	250MHz	6.5GHz	New
LQW15AN8N4G80□	8.4nH ±2%	100MHz	1500mA	0.069Ω	32	250MHz	6.5GHz	New
LQW15AN8N4J80□	8.4nH ±5%	100MHz	1500mA	0.069Ω	32	250MHz	6.5GHz	New
LQW15AN8N5G80□	8.5nH ±2%	100MHz	1500mA	0.069Ω	32	250MHz	6.5GHz	New
LQW15AN8N5J80□	8.5nH ±5%	100MHz	1500mA	0.069Ω	32	250MHz	6.5GHz	New
LQW15AN8N6G80□	8.6nH ±2%	100MHz	1420mA	0.070Ω	31	250MHz	6.5GHz	New
LQW15AN8N6J80□	8.6nH ±5%	100MHz	1420mA	0.070Ω	31	250MHz	6.5GHz	New
LQW15AN8N7G80□	8.7nH ±2%	100MHz	1420mA	0.070Ω	31	250MHz	6.5GHz	New
LQW15AN8N7J80□	8.7nH ±5%	100MHz	1420mA	0.070Ω	31	250MHz	6.5GHz	New
LQW15AN8N8G80□	8.8nH ±2%	100MHz	1420mA	0.070Ω	31	250MHz	6.5GHz	New
LQW15AN8N8J80□	8.8nH ±5%	100MHz	1420mA	0.070Ω	31	250MHz	6.5GHz	New

Operating Temperature Range (Self-temperature rise is not included): -55°C~+125°C
For reflow soldering only.

Continued on the following page. 

△Note • Please read rating and △CAUTION (for storage, operating, rating, soldering, mounting and handling) in this catalog to prevent smoking and/or burning, etc.
• This catalog has only typical specifications. Therefore, please approve our product specifications or transact the approval sheet for product specifications before ordering.

Part Number	Inductance	Inductance Test Frequency	Rated Current	Max. of DC Resistance	Q (min.)	Q Test Frequency	Self-Resonance Frequency (min.)	
LQW15AN8N9G80□	8.9nH ±2%	100MHz	1420mA	0.070Ω	31	250MHz	6.5GHz	New
LQW15AN8N9J80□	8.9nH ±5%	100MHz	1420mA	0.070Ω	31	250MHz	6.5GHz	New
LQW15AN9N0G80□	9nH ±2%	100MHz	1420mA	0.070Ω	30	250MHz	6.5GHz	New
LQW15AN9N0J80□	9nH ±5%	100MHz	1420mA	0.070Ω	30	250MHz	6.5GHz	New
LQW15AN9N1G80□	9.1nH ±2%	100MHz	1400mA	0.080Ω	32	250MHz	6.5GHz	New
LQW15AN9N1J80□	9.1nH ±5%	100MHz	1400mA	0.080Ω	32	250MHz	6.5GHz	New
LQW15AN9N2G80□	9.2nH ±2%	100MHz	1400mA	0.081Ω	32	250MHz	6.0GHz	New
LQW15AN9N2J80□	9.2nH ±5%	100MHz	1400mA	0.081Ω	32	250MHz	6.0GHz	New
LQW15AN9N3G80□	9.3nH ±2%	100MHz	1400mA	0.081Ω	34	250MHz	6.0GHz	New
LQW15AN9N3J80□	9.3nH ±5%	100MHz	1400mA	0.081Ω	34	250MHz	6.0GHz	New
LQW15AN9N4G80□	9.4nH ±2%	100MHz	1400mA	0.081Ω	33	250MHz	6.0GHz	New
LQW15AN9N4J80□	9.4nH ±5%	100MHz	1400mA	0.081Ω	33	250MHz	6.0GHz	New
LQW15AN9N5G80□	9.5nH ±2%	100MHz	1400mA	0.081Ω	32	250MHz	6.0GHz	New
LQW15AN9N5J80□	9.5nH ±5%	100MHz	1400mA	0.081Ω	32	250MHz	6.0GHz	New
LQW15AN9N6G80□	9.6nH ±2%	100MHz	1400mA	0.081Ω	33	250MHz	6.0GHz	New
LQW15AN9N6J80□	9.6nH ±5%	100MHz	1400mA	0.081Ω	33	250MHz	6.0GHz	New
LQW15AN9N7G80□	9.7nH ±2%	100MHz	1400mA	0.081Ω	33	250MHz	6.0GHz	New
LQW15AN9N7J80□	9.7nH ±5%	100MHz	1400mA	0.081Ω	33	250MHz	6.0GHz	New
LQW15AN9N8G80□	9.8nH ±2%	100MHz	1400mA	0.081Ω	34	250MHz	6.0GHz	New
LQW15AN9N8J80□	9.8nH ±5%	100MHz	1400mA	0.081Ω	34	250MHz	6.0GHz	New
LQW15AN9N9G80□	9.9nH ±2%	100MHz	1400mA	0.081Ω	32	250MHz	6.0GHz	New
LQW15AN9N9J80□	9.9nH ±5%	100MHz	1400mA	0.081Ω	32	250MHz	6.0GHz	New
LQW15AN10NG80□	10nH ±2%	100MHz	1400mA	0.081Ω	31	250MHz	6.0GHz	New
LQW15AN10NJ80□	10nH ±5%	100MHz	1400mA	0.081Ω	31	250MHz	6.0GHz	New
LQW15AN11NG80□	11nH ±2%	100MHz	1400mA	0.083Ω	32	250MHz	6.2GHz	New
LQW15AN11NJ80□	11nH ±5%	100MHz	1400mA	0.083Ω	32	250MHz	6.2GHz	New
LQW15AN12NG80□	12nH ±2%	100MHz	1240mA	0.093Ω	30	250MHz	5.2GHz	New
LQW15AN12NJ80□	12nH ±5%	100MHz	1240mA	0.093Ω	30	250MHz	5.2GHz	New
LQW15AN13NG80□	13nH ±2%	100MHz	1240mA	0.093Ω	30	250MHz	5.2GHz	Kit
LQW15AN13NJ80□	13nH ±5%	100MHz	1240mA	0.093Ω	30	250MHz	5.2GHz	
LQW15AN14NG80□	14nH ±2%	100MHz	1150mA	0.111Ω	31	250MHz	5.2GHz	New
LQW15AN14NJ80□	14nH ±5%	100MHz	1150mA	0.111Ω	31	250MHz	5.2GHz	New
LQW15AN15NG80□	15nH ±2%	100MHz	1150mA	0.114Ω	31	250MHz	5.5GHz	New
LQW15AN15NJ80□	15nH ±5%	100MHz	1150mA	0.114Ω	31	250MHz	5.5GHz	New
LQW15AN16NG80□	16nH ±2%	100MHz	1000mA	0.126Ω	31	250MHz	5.0GHz	New
LQW15AN16NJ80□	16nH ±5%	100MHz	1000mA	0.126Ω	31	250MHz	5.0GHz	New
LQW15AN17NG80□	17nH ±2%	100MHz	1000mA	0.126Ω	30	250MHz	5.0GHz	New
LQW15AN17NJ80□	17nH ±5%	100MHz	1000mA	0.126Ω	30	250MHz	5.0GHz	New
LQW15AN18NG80□	18nH ±2%	100MHz	1050mA	0.130Ω	30	250MHz	5.2GHz	New
LQW15AN18NJ80□	18nH ±5%	100MHz	1050mA	0.130Ω	30	250MHz	5.2GHz	New
LQW15AN19NG80□	19nH ±2%	100MHz	920mA	0.156Ω	30	250MHz	5.0GHz	New
LQW15AN19NJ80□	19nH ±5%	100MHz	920mA	0.156Ω	30	250MHz	5.0GHz	New
LQW15AN20NG80□	20nH ±2%	100MHz	800mA	0.186Ω	30	250MHz	4.5GHz	New
LQW15AN20NJ80□	20nH ±5%	100MHz	800mA	0.186Ω	30	250MHz	4.5GHz	New
LQW15AN21NG80□	21nH ±2%	100MHz	780mA	0.202Ω	30	250MHz	4.5GHz	New
LQW15AN21NJ80□	21nH ±5%	100MHz	780mA	0.202Ω	30	250MHz	4.5GHz	New
LQW15AN22NG80□	22nH ±2%	100MHz	780mA	0.202Ω	30	250MHz	4.5GHz	New
LQW15AN22NJ80□	22nH ±5%	100MHz	780mA	0.202Ω	30	250MHz	4.5GHz	New

Operating Temperature Range (Self-temperature rise is not included): -55°C~+125°C
For reflow soldering only.

Continued on the following page. 

△Note • Please read rating and △CAUTION (for storage, operating, rating, soldering, mounting and handling) in this catalog to prevent smoking and/or burning, etc.
• This catalog has only typical specifications. Therefore, please approve our product specifications or transact the approval sheet for product specifications before ordering.

Part Number	Inductance	Inductance Test Frequency	Rated Current	Max. of DC Resistance	Q (min.)	Q Test Frequency	Self-Resonance Frequency (min.)	
LQW15AN23NG80	23nH ±2%	100MHz	760mA	0.201Ω	29	250MHz	4.5GHz	New
LQW15AN23NJ80	23nH ±5%	100MHz	760mA	0.201Ω	29	250MHz	4.5GHz	New
LQW15AN24NG80	24nH ±2%	100MHz	770mA	0.212Ω	31	250MHz	4.0GHz	New
LQW15AN24NJ80	24nH ±5%	100MHz	770mA	0.212Ω	31	250MHz	4.0GHz	New
LQW15AN25NG80	25nH ±2%	100MHz	750mA	0.221Ω	31	250MHz	4.1GHz	New
LQW15AN25NJ80	25nH ±5%	100MHz	750mA	0.221Ω	31	250MHz	4.1GHz	New
LQW15AN26NG80	26nH ±2%	100MHz	720mA	0.282Ω	29	250MHz	4.1GHz	New
LQW15AN26NJ80	26nH ±5%	100MHz	720mA	0.282Ω	29	250MHz	4.1GHz	New
LQW15AN27NG80	27nH ±2%	100MHz	680mA	0.288Ω	30	250MHz	4.0GHz	Kit
LQW15AN27NJ80	27nH ±5%	100MHz	680mA	0.288Ω	30	250MHz	4.0GHz	
LQW15AN30NG80	30nH ±2%	100MHz	660mA	0.309Ω	30	250MHz	3.8GHz	New
LQW15AN30NJ80	30nH ±5%	100MHz	660mA	0.309Ω	30	250MHz	3.8GHz	New
LQW15AN33NG80	33nH ±2%	100MHz	620mA	0.336Ω	30	250MHz	3.6GHz	Kit
LQW15AN33NJ80	33nH ±5%	100MHz	620mA	0.336Ω	30	250MHz	3.6GHz	
LQW15AN36NG80	36nH ±2%	100MHz	540mA	0.431Ω	30	250MHz	3.5GHz	New
LQW15AN36NJ80	36nH ±5%	100MHz	540mA	0.431Ω	30	250MHz	3.5GHz	New
LQW15AN39NG80	39nH ±2%	100MHz	530mA	0.456Ω	28	250MHz	3.4GHz	New
LQW15AN39NJ80	39nH ±5%	100MHz	530mA	0.456Ω	28	250MHz	3.4GHz	New
LQW15AN43NG80	43nH ±2%	100MHz	515mA	0.516Ω	30	250MHz	3.4GHz	Kit
LQW15AN43NJ80	43nH ±5%	100MHz	515mA	0.516Ω	30	250MHz	3.4GHz	
LQW15AN47NG80	47nH ±2%	100MHz	440mA	0.648Ω	25	200MHz	3.2GHz	New
LQW15AN47NJ80	47nH ±5%	100MHz	440mA	0.648Ω	25	200MHz	3.2GHz	New
LQW15AN51NG80	51nH ±2%	100MHz	415mA	0.696Ω	25	200MHz	2.9GHz	New
LQW15AN51NJ80	51nH ±5%	100MHz	415mA	0.696Ω	25	200MHz	2.9GHz	New
LQW15AN53NG80	53nH ±2%	100MHz	415mA	0.696Ω	25	200MHz	2.9GHz	Kit
LQW15AN53NJ80	53nH ±5%	100MHz	415mA	0.696Ω	25	200MHz	2.9GHz	
LQW15AN56NG80	56nH ±2%	100MHz	340mA	0.996Ω	25	200MHz	2.9GHz	New
LQW15AN56NJ80	56nH ±5%	100MHz	340mA	0.996Ω	25	200MHz	2.9GHz	New
LQW15AN68NG80	68nH ±2%	100MHz	320mA	1.128Ω	25	200MHz	2.5GHz	New
LQW15AN68NJ80	68nH ±5%	100MHz	320mA	1.128Ω	25	200MHz	2.5GHz	New
LQW15AN75NG80	75nH ±2%	100MHz	320mA	1.224Ω	25	200MHz	2.4GHz	Kit
LQW15AN75NJ80	75nH ±5%	100MHz	320mA	1.224Ω	25	200MHz	2.4GHz	

Operating Temperature Range (Self-temperature rise is not included): -55°C~+125°C
For reflow soldering only.

■ Q-Frequency Characteristics (Typ.)

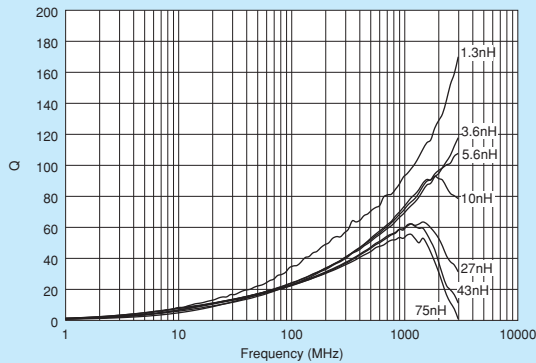

■ Inductance-Frequency Characteristics (Typ.)

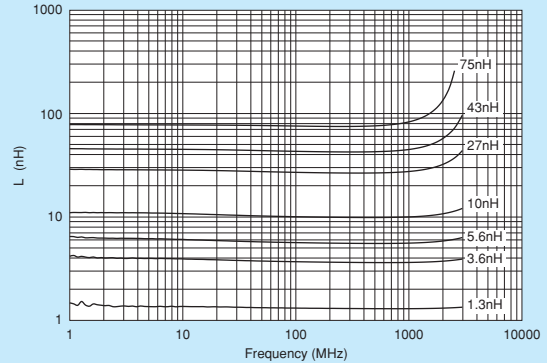

Continued on the following page.

△Note • Please read rating and △CAUTION (for storage, operating, rating, soldering, mounting and handling) in this catalog to prevent smoking and/or burning, etc.
• This catalog has only typical specifications. Therefore, please approve our product specifications or transact the approval sheet for product specifications before ordering.

Derating of Rated Current

In operating temperature exceeding +85°C, derating of current is necessary for LQW15AN_80 series. Please apply the derating curve shown in chart according to the operating temperature.

Derating of Rated Current

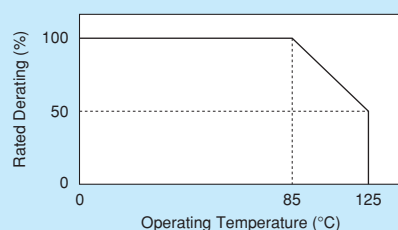

Reference Data

4991A&16197A

Part Number	Inductance (nH)	Q (Typ.)				
	Nominal	800MHz	900MHz	1.8GHz	2.0GHz	2.4GHz
LQW15AN1N3	1.3	83	88	121	128	144
LQW15AN1N6	1.6	53	57	87	93	101
LQW15AN1N7	1.7	52	57	86	92	100
LQW15AN2N3	2.3	70	74	104	108	119
LQW15AN2N4	2.4	63	67	93	97	107
LQW15AN2N5	2.5	64	68	102	109	119
LQW15AN2N6	2.6	64	68	102	107	115
LQW15AN2N7	2.7	60	64	95	102	111
LQW15AN2N8	2.8	61	66	99	104	110
LQW15AN2N9	2.9	61	65	97	102	108
LQW15AN3N4	3.4	66	70	96	99	108
LQW15AN3N5	3.5	74	77	107	110	119
LQW15AN3N6	3.6	62	66	91	94	103
LQW15AN3N7	3.7	74	78	104	108	117
LQW15AN3N8	3.8	68	72	99	103	111
LQW15AN3N9	3.9	75	80	110	114	121
LQW15AN4N0	4.0	68	71	97	101	108
LQW15AN4N2	4.2	70	75	107	112	120
LQW15AN4N4	4.4	65	69	99	103	105
LQW15AN4N5	4.5	66	70	99	103	105
LQW15AN4N7	4.7	58	61	85	90	95
LQW15AN4N8	4.8	58	61	83	87	93
LQW15AN5N1	5.1	64	68	94	97	104
LQW15AN5N2	5.2	66	70	96	100	107
LQW15AN5N3	5.3	71	75	103	106	114
LQW15AN5N4	5.4	62	66	88	92	95
LQW15AN5N5	5.5	70	74	99	102	107
LQW15AN5N6	5.6	64	68	93	96	100
LQW15AN5N7	5.7	68	73	97	101	107
LQW15AN5N8	5.8	65	69	92	94	97
LQW15AN5N9	5.9	69	73	96	98	103
LQW15AN6N0	6.0	63	67	94	96	96

Continued on the following page.

Note • Please read rating and CAUTION (for storage, operating, rating, soldering, mounting and handling) in this catalog to prevent smoking and/or burning, etc.
• This catalog has only typical specifications. Therefore, please approve our product specifications or transact the approval sheet for product specifications before ordering.

Part Number	Inductance (nH)	Q (Typ.)				
	Nominal	800MHz	900MHz	1.8GHz	2.0GHz	2.4GHz
LQW15AN6N2	6.2	70	74	102	104	102
LQW15AN6N4	6.4	59	64	89	91	90
LQW15AN6N5	6.5	62	66	84	83	76
LQW15AN6N6	6.6	64	68	92	94	93
LQW15AN6N7	6.7	62	66	90	92	91
LQW15AN6N9	6.9	65	70	96	97	93
LQW15AN7N0	7.0	66	71	101	104	105
LQW15AN7N4	7.4	63	67	91	93	97
LQW15AN7N5	7.5	65	69	89	92	98
LQW15AN7N6	7.6	64	68	90	92	93
LQW15AN7N7	7.7	62	66	86	88	88
LQW15AN7N8	7.8	66	71	89	90	87
LQW15AN7N9	7.9	69	72	92	94	96
LQW15AN8N0	8.0	64	67	84	84	81
LQW15AN8N2	8.2	63	67	89	92	95
LQW15AN8N4	8.4	68	72	96	96	91
LQW15AN9N1	9.1	62	66	87	87	82
LQW15AN9N2	9.2	61	65	89	90	87
LQW15AN9N4	9.4	65	70	96	97	93
LQW15AN9N5	9.5	63	67	89	90	85
LQW15AN9N6	9.6	65	69	92	92	87
LQW15AN9N8	9.8	63	67	92	93	89
LQW15AN10N	10	65	70	92	91	85
LQW15AN12N	12	60	64	82	85	86
LQW15AN13N	13	60	63	74	73	65
LQW15AN16N	16	61	64	80	78	68
LQW15AN20N	20	58	61	70	67	57
LQW15AN21N	21	59	63	72	69	57
LQW15AN24N	24	56	59	67	63	51
LQW15AN25N	25	57	60	70	66	54
LQW15AN27N	27	55	58	58	53	40
LQW15AN33N	33	54	56	50	45	32
LQW15AN43N	43	56	59	48	38	21
LQW15AN51N	51	55	59	37	30	32
LQW15AN53N	53	53	55	50	43	26
LQW15AN68N	68	49	50	37	31	16
LQW15AN75N	75	52	53	40	31	15

△Note • Please read rating and △CAUTION (for storage, operating, rating, soldering, mounting and handling) in this catalog to prevent smoking and/or burning, etc.
 • This catalog has only typical specifications. Therefore, please approve our product specifications or transact the approval sheet for product specifications before ordering.

LQW18AN_00 Series 0603/1608 (inch/mm)

Size Code 0603 (1608) in inch (in mm), Wound Type

■ Appearance/Dimensions

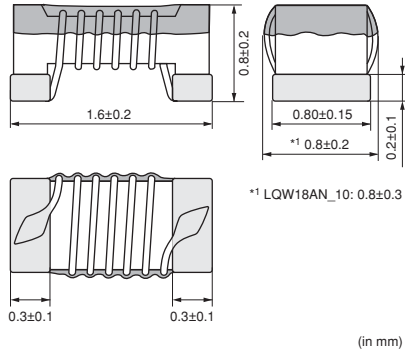

■ Packaging

Code	Packaging	Minimum Quantity
D	ø180mm Paper Taping	4000
J	ø330mm Paper Taping	10000
B	Packing in Bulk	500



Refer to pages 227 to 230 for mounting information.

■ Rated Value (□: packaging code)

Part Number	Inductance	Inductance Test Frequency	Rated Current	Max. of DC Resistance	Q (min.)	Q Test Frequency	Self-Resonance Frequency (min.)	
LQW18AN2N2D00□	2.2nH ±0.5nH	100MHz	700mA	0.049Ω	16	250MHz	6000MHz	
LQW18AN3N6C00□	3.6nH ±0.2nH	100MHz	850mA	0.059Ω	25	250MHz	6000MHz	Kit
LQW18AN3N6D00□	3.6nH ±0.5nH	100MHz	850mA	0.059Ω	25	250MHz	6000MHz	
LQW18AN3N9C00□	3.9nH ±0.2nH	100MHz	850mA	0.059Ω	35	250MHz	6000MHz	Kit
LQW18AN3N9D00□	3.9nH ±0.5nH	100MHz	850mA	0.059Ω	35	250MHz	6000MHz	
LQW18AN4N3C00□	4.3nH ±0.2nH	100MHz	850mA	0.059Ω	35	250MHz	6000MHz	Kit
LQW18AN4N3D00□	4.3nH ±0.5nH	100MHz	850mA	0.059Ω	35	250MHz	6000MHz	
LQW18AN4N7D00□	4.7nH ±0.5nH	100MHz	850mA	0.059Ω	35	250MHz	6000MHz	
LQW18AN5N6C00□	5.6nH ±0.2nH	100MHz	750mA	0.082Ω	35	250MHz	6000MHz	Kit
LQW18AN5N6D00□	5.6nH ±0.5nH	100MHz	750mA	0.082Ω	35	250MHz	6000MHz	
LQW18AN6N2C00□	6.2nH ±0.2nH	100MHz	750mA	0.082Ω	35	250MHz	6000MHz	Kit
LQW18AN6N2D00□	6.2nH ±0.5nH	100MHz	750mA	0.082Ω	35	250MHz	6000MHz	
LQW18AN6N8C00□	6.8nH ±0.2nH	100MHz	750mA	0.082Ω	35	250MHz	6000MHz	Kit
LQW18AN6N8D00□	6.8nH ±0.5nH	100MHz	750mA	0.082Ω	35	250MHz	6000MHz	
LQW18AN7N5C00□	7.5nH ±0.2nH	100MHz	750mA	0.082Ω	35	250MHz	6000MHz	
LQW18AN7N5D00□	7.5nH ±0.5nH	100MHz	750mA	0.082Ω	35	250MHz	6000MHz	
LQW18AN8N2C00□	8.2nH ±0.2nH	100MHz	650mA	0.11Ω	35	250MHz	6000MHz	
LQW18AN8N2D00□	8.2nH ±0.5nH	100MHz	650mA	0.11Ω	35	250MHz	6000MHz	
LQW18AN8N7C00□	8.7nH ±0.2nH	100MHz	650mA	0.11Ω	35	250MHz	6000MHz	
LQW18AN8N7D00□	8.7nH ±0.5nH	100MHz	650mA	0.11Ω	35	250MHz	6000MHz	
LQW18AN9N1C00□	9.1nH ±0.2nH	100MHz	650mA	0.11Ω	35	250MHz	6000MHz	
LQW18AN9N1D00□	9.1nH ±0.5nH	100MHz	650mA	0.11Ω	35	250MHz	6000MHz	
LQW18AN9N5D00□	9.5nH ±0.5nH	100MHz	650mA	0.11Ω	35	250MHz	6000MHz	
LQW18AN10NG00□	10nH ±2%	100MHz	650mA	0.11Ω	35	250MHz	6000MHz	Kit
LQW18AN10NJ00□	10nH ±5%	100MHz	650mA	0.11Ω	35	250MHz	6000MHz	
LQW18AN11NG00□	11nH ±2%	100MHz	650mA	0.11Ω	35	250MHz	6000MHz	Kit
LQW18AN11NJ00□	11nH ±5%	100MHz	650mA	0.11Ω	35	250MHz	6000MHz	
LQW18AN12NG00□	12nH ±2%	100MHz	600mA	0.13Ω	35	250MHz	6000MHz	Kit
LQW18AN12NJ00□	12nH ±5%	100MHz	600mA	0.13Ω	35	250MHz	6000MHz	
LQW18AN13NG00□	13nH ±2%	100MHz	600mA	0.13Ω	35	250MHz	6000MHz	Kit
LQW18AN13NJ00□	13nH ±5%	100MHz	600mA	0.13Ω	35	250MHz	6000MHz	
LQW18AN15NG00□	15nH ±2%	100MHz	600mA	0.13Ω	40	250MHz	6000MHz	Kit

Operating Temperature Range (Self-temperature rise is not included): -55°C~+125°C
For reflow soldering only.

Continued on the following page.

△Note • Please read rating and △CAUTION (for storage, operating, rating, soldering, mounting and handling) in this catalog to prevent smoking and/or burning, etc.
• This catalog has only typical specifications. Therefore, please approve our product specifications or transact the approval sheet for product specifications before ordering.

Part Number	Inductance	Inductance Test Frequency	Rated Current	Max. of DC Resistance	Q (min.)	Q Test Frequency	Self-Resonance Frequency (min.)	
LQW18AN15NJ00□	15nH ±5%	100MHz	600mA	0.13Ω	40	250MHz	6000MHz	
LQW18AN16NG00□	16nH ±2%	100MHz	550mA	0.16Ω	40	250MHz	5500MHz	Kit
LQW18AN16NJ00□	16nH ±5%	100MHz	550mA	0.16Ω	40	250MHz	5500MHz	
LQW18AN18NG00□	18nH ±2%	100MHz	550mA	0.16Ω	40	250MHz	5500MHz	Kit
LQW18AN18NJ00□	18nH ±5%	100MHz	550mA	0.16Ω	40	250MHz	5500MHz	
LQW18AN20NG00□	20nH ±2%	100MHz	550mA	0.16Ω	40	250MHz	4900MHz	Kit
LQW18AN20NJ00□	20nH ±5%	100MHz	550mA	0.16Ω	40	250MHz	4900MHz	
LQW18AN22NG00□	22nH ±2%	100MHz	500mA	0.17Ω	40	250MHz	4600MHz	Kit
LQW18AN22NJ00□	22nH ±5%	100MHz	500mA	0.17Ω	40	250MHz	4600MHz	
LQW18AN24NG00□	24nH ±2%	100MHz	500mA	0.21Ω	40	250MHz	3800MHz	Kit
LQW18AN24NJ00□	24nH ±5%	100MHz	500mA	0.21Ω	40	250MHz	3800MHz	
LQW18AN27NG00□	27nH ±2%	100MHz	440mA	0.21Ω	40	250MHz	3700MHz	Kit
LQW18AN27NJ00□	27nH ±5%	100MHz	440mA	0.21Ω	40	250MHz	3700MHz	
LQW18AN30NG00□	30nH ±2%	100MHz	420mA	0.23Ω	40	250MHz	3300MHz	Kit
LQW18AN30NJ00□	30nH ±5%	100MHz	420mA	0.23Ω	40	250MHz	3300MHz	
LQW18AN33NG00□	33nH ±2%	100MHz	420mA	0.23Ω	40	250MHz	3200MHz	Kit
LQW18AN33NJ00□	33nH ±5%	100MHz	420mA	0.23Ω	40	250MHz	3200MHz	
LQW18AN36NG00□	36nH ±2%	100MHz	400mA	0.26Ω	40	250MHz	2900MHz	Kit
LQW18AN36NJ00□	36nH ±5%	100MHz	400mA	0.26Ω	40	250MHz	2900MHz	
LQW18AN39NG00□	39nH ±2%	100MHz	400mA	0.26Ω	40	250MHz	2800MHz	Kit
LQW18AN39NJ00□	39nH ±5%	100MHz	400mA	0.26Ω	40	250MHz	2800MHz	
LQW18AN43NG00□	43nH ±2%	100MHz	380mA	0.29Ω	40	200MHz	2700MHz	Kit
LQW18AN43NJ00□	43nH ±5%	100MHz	380mA	0.29Ω	40	200MHz	2700MHz	
LQW18AN47NG00□	47nH ±2%	100MHz	380mA	0.29Ω	38	200MHz	2600MHz	Kit
LQW18AN47NJ00□	47nH ±5%	100MHz	380mA	0.29Ω	38	200MHz	2600MHz	
LQW18AN51NG00□	51nH ±2%	100MHz	370mA	0.33Ω	38	200MHz	2500MHz	Kit
LQW18AN51NJ00□	51nH ±5%	100MHz	370mA	0.33Ω	38	200MHz	2500MHz	
LQW18AN56NG00□	56nH ±2%	100MHz	360mA	0.35Ω	38	200MHz	2400MHz	Kit
LQW18AN56NJ00□	56nH ±5%	100MHz	360mA	0.35Ω	38	200MHz	2400MHz	
LQW18AN62NG00□	62nH ±2%	100MHz	280mA	0.51Ω	38	200MHz	2300MHz	Kit
LQW18AN62NJ00□	62nH ±5%	100MHz	280mA	0.51Ω	38	200MHz	2300MHz	
LQW18AN68NG00□	68nH ±2%	100MHz	340mA	0.38Ω	38	200MHz	2200MHz	Kit
LQW18AN68NJ00□	68nH ±5%	100MHz	340mA	0.38Ω	38	200MHz	2200MHz	
LQW18AN72NG00□	72nH ±2%	100MHz	270mA	0.56Ω	34	150MHz	2100MHz	Kit
LQW18AN72NJ00□	72nH ±5%	100MHz	270mA	0.56Ω	34	150MHz	2100MHz	
LQW18AN75NG00□	75nH ±2%	100MHz	270mA	0.56Ω	34	150MHz	2050MHz	Kit
LQW18AN75NJ00□	75nH ±5%	100MHz	270mA	0.56Ω	34	150MHz	2050MHz	
LQW18AN82NG00□	82nH ±2%	100MHz	250mA	0.60Ω	34	150MHz	2000MHz	Kit
LQW18AN82NJ00□	82nH ±5%	100MHz	250mA	0.60Ω	34	150MHz	2000MHz	
LQW18AN91NG00□	91nH ±2%	100MHz	230mA	0.64Ω	34	150MHz	1900MHz	Kit
LQW18AN91NJ00□	91nH ±5%	100MHz	230mA	0.64Ω	34	150MHz	1900MHz	
LQW18ANR10G00□	100nH ±2%	100MHz	220mA	0.68Ω	34	150MHz	1800MHz	Kit
LQW18ANR10J00□	100nH ±5%	100MHz	220mA	0.68Ω	34	150MHz	1800MHz	
LQW18ANR11G00□	110nH ±2%	100MHz	200mA	1.2Ω	32	150MHz	1700MHz	Kit
LQW18ANR11J00□	110nH ±5%	100MHz	200mA	1.2Ω	32	150MHz	1700MHz	
LQW18ANR12G00□	120nH ±2%	100MHz	180mA	1.3Ω	32	150MHz	1600MHz	Kit
LQW18ANR12J00□	120nH ±5%	100MHz	180mA	1.3Ω	32	150MHz	1600MHz	

Operating Temperature Range (Self-temperature rise is not included): -55°C~+125°C
For reflow soldering only.

Continued on the following page. 

△Note • Please read rating and △CAUTION (for storage, operating, rating, soldering, mounting and handling) in this catalog to prevent smoking and/or burning, etc.
• This catalog has only typical specifications. Therefore, please approve our product specifications or transact the approval sheet for product specifications before ordering.

Part Number	Inductance	Inductance Test Frequency	Rated Current	Max. of DC Resistance	Q (min.)	Q Test Frequency	Self-Resonance Frequency (min.)	
LQW18ANR13G00	130nH ±2%	100MHz	170mA	1.4Ω	32	150MHz	1450MHz	Kit
LQW18ANR13J00	130nH ±5%	100MHz	170mA	1.4Ω	32	150MHz	1450MHz	
LQW18ANR15G00	150nH ±2%	100MHz	160mA	1.5Ω	32	150MHz	1400MHz	Kit
LQW18ANR15J00	150nH ±5%	100MHz	160mA	1.5Ω	32	150MHz	1400MHz	
LQW18ANR16G00	160nH ±2%	100MHz	150mA	2.1Ω	32	150MHz	1350MHz	Kit
LQW18ANR16J00	160nH ±5%	100MHz	150mA	2.1Ω	32	150MHz	1350MHz	
LQW18ANR18G00	180nH ±2%	100MHz	140mA	2.2Ω	25	100MHz	1300MHz	Kit
LQW18ANR18J00	180nH ±5%	100MHz	140mA	2.2Ω	25	100MHz	1300MHz	
LQW18ANR20G00	200nH ±2%	100MHz	120mA	2.4Ω	25	100MHz	1250MHz	Kit
LQW18ANR20J00	200nH ±5%	100MHz	120mA	2.4Ω	25	100MHz	1250MHz	
LQW18ANR22G00	220nH ±2%	100MHz	120mA	2.5Ω	25	100MHz	1200MHz	Kit
LQW18ANR22J00	220nH ±5%	100MHz	120mA	2.5Ω	25	100MHz	1200MHz	
LQW18ANR27G00	270nH ±2%	100MHz	110mA	3.4Ω	30	100MHz	960MHz	Kit
LQW18ANR27J00	270nH ±5%	100MHz	110mA	3.4Ω	30	100MHz	960MHz	
LQW18ANR33G00	330nH ±2%	100MHz	85mA	5.5Ω	30	100MHz	800MHz	Kit
LQW18ANR33J00	330nH ±5%	100MHz	85mA	5.5Ω	30	100MHz	800MHz	
LQW18ANR39G00	390nH ±2%	100MHz	80mA	6.2Ω	30	100MHz	800MHz	Kit
LQW18ANR39J00	390nH ±5%	100MHz	80mA	6.2Ω	30	100MHz	800MHz	
LQW18ANR47G00	470nH ±2%	100MHz	75mA	7.0Ω	30	100MHz	700MHz	Kit
LQW18ANR47J00	470nH ±5%	100MHz	75mA	7.0Ω	30	100MHz	700MHz	

Operating Temperature Range (Self-temperature rise is not included): -55°C~+125°C
 For reflow soldering only.

■ Q-Frequency Characteristics (Typ.)

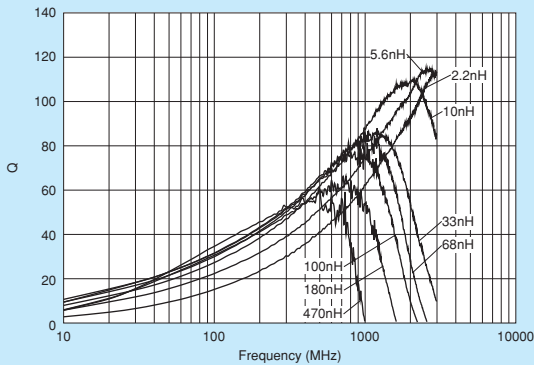

■ Inductance-Frequency Characteristics (Typ.)

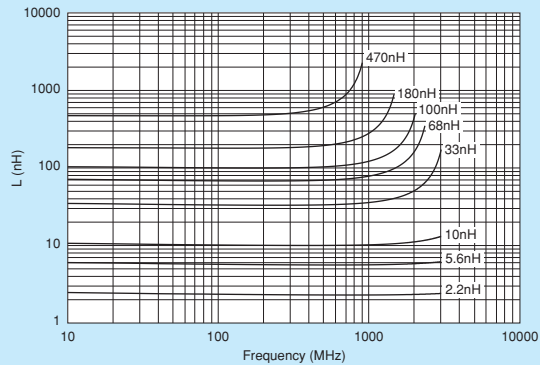

Continued on the following page.

⚠Note • Please read rating and ⚠CAUTION (for storage, operating, rating, soldering, mounting and handling) in this catalog to prevent smoking and/or burning, etc.
 • This catalog has only typical specifications. Therefore, please approve our product specifications or transact the approval sheet for product specifications before ordering.

■ Reference Data

LQW18AN_00

4991A&16197A

Part Number	Inductance (nH)	Q (Typ.)				
	Nominal	800MHz	900MHz	1.8GHz	2.0GHz	2.4GHz
LQW18AN2N2□00	2.2	74	77	113	124	134
LQW18AN3N6□00	3.6	60	63	92	94	103
LQW18AN3N9□00	3.9	65	68	97	99	109
LQW18AN4N3□00	4.3	71	74	105	107	118
LQW18AN4N7□00	4.7	72	75	108	120	130
LQW18AN5N6□00	5.6	67	70	100	103	113
LQW18AN6N2□00	6.2	70	73	105	107	118
LQW18AN6N8□00	6.8	78	82	115	117	127
LQW18AN7N5□00	7.5	85	86	117	132	140
LQW18AN8N2□00	8.2	73	78	112	116	130
LQW18AN8N7□00	8.7	80	82	115	132	143
LQW18AN9N1□00	9.1	86	88	124	142	155
LQW18AN9N5□00	9.5	79	84	119	119	132
LQW18AN10N□00	10	75	78	103	102	105
LQW18AN11N□00	11	82	85	110	108	110
LQW18AN12N□00	12	80	84	114	114	120
LQW18AN13N□00	13	79	82	108	105	107
LQW18AN15N□00	15	81	84	102	97	92
LQW18AN16N□00	16	86	90	119	116	119
LQW18AN18N□00	18	82	85	101	96	89
LQW18AN20N□00	20	81	83	95	90	78
LQW18AN22N□00	22	84	88	104	101	95
LQW18AN24N□00	24	80	82	92	86	75
LQW18AN27N□00	27	79	81	80	72	57
LQW18AN30N□00	30	81	82	84	75	59
LQW18AN33N□00	33	78	79	71	60	43
LQW18AN36N□00	36	79	81	73	62	44
LQW18AN39N□00	39	78	78	66	55	37
LQW18AN43N□00	43	79	81	73	61	43
LQW18AN47N□00	47	75	74	55	42	24
LQW18AN51N□00	51	77	78	60	46	26
LQW18AN56N□00	56	80	82	66	51	31
LQW18AN62N□00	62	71	71	40	26	7
LQW18AN68N□00	68	75	77	46	31	11
LQW18AN72N□00	72	69	69	37	23	4
LQW18AN75N□00	75	68	66	32	18	-
LQW18AN82N□00	82	66	64	26	12	-
LQW18AN91N□00	91	66	65	22	8	-
LQW18ANR10□00	100	68	67	24	9	-
LQW18ANR11□00	110	65	63	15	1	-
LQW18ANR12□00	120	64	62	11	-	-
LQW18ANR13□00	130	62	59	7	-	-
LQW18ANR15□00	150	60	57	3	-	-
LQW18ANR16□00	160	59	54	-	-	-
LQW18ANR18□00	180	60	55	-	-	-
LQW18ANR20□00	200	57	54	-	-	-
LQW18ANR22□00	220	54	47	-	-	-
LQW18ANR27□00	270	52	46	-	-	-
LQW18ANR33□00	330	47	35	-	-	-
LQW18ANR39□00	390	33	23	-	-	-
LQW18ANR47□00	470	22	13	-	-	-

△Note • Please read rating and △CAUTION (for storage, operating, rating, soldering, mounting and handling) in this catalog to prevent smoking and/or burning, etc.
 • This catalog has only typical specifications. Therefore, please approve our product specifications or transact the approval sheet for product specifications before ordering.

LQW18AN_10

Series 0603/1608 (inch/mm)

Size Code 0603 (1608) in inch (in mm), High Q, Low DC Resistance Type

■ Appearance/ Dimensions

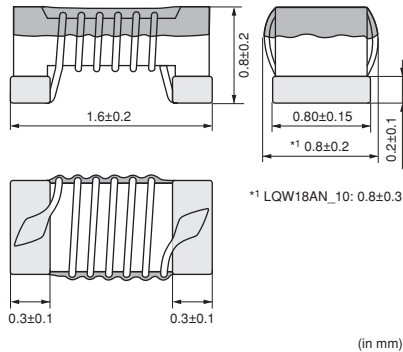

■ Packaging

Code	Packaging	Minimum Quantity
D	ø180mm Paper Taping	4000
J	ø330mm Paper Taping	10000
B	Packing in Bulk	500



Refer to pages 227 to 230 for mounting information.

■ Rated Value (□: packaging code)

Part Number	Inductance	Inductance Test Frequency	Rated Current	Max. of DC Resistance	Q (min.)	Q Test Frequency	Self-Resonance Frequency (min.)	
LQW18AN2N2D10□	2.2nH ±0.5nH	100MHz	1400mA	0.018Ω	25	250MHz	18000MHz	
LQW18AN3N9C10□	3.9nH ±0.2nH	100MHz	1000mA	0.032Ω	38	250MHz	11000MHz	Kit
LQW18AN3N9D10□	3.9nH ±0.5nH	100MHz	1000mA	0.032Ω	38	250MHz	11000MHz	
LQW18AN5N6D10□	5.6nH ±0.5nH	100MHz	900mA	0.045Ω	38	250MHz	10000MHz	
LQW18AN6N8C10□	6.8nH ±0.2nH	100MHz	900mA	0.045Ω	38	250MHz	7000MHz	Kit
LQW18AN6N8D10□	6.8nH ±0.5nH	100MHz	900mA	0.045Ω	38	250MHz	7000MHz	
LQW18AN8N2D10□	8.2nH ±0.5nH	100MHz	800mA	0.058Ω	38	250MHz	7000MHz	
LQW18AN10NG10□	10nH ±2%	100MHz	800mA	0.058Ω	38	250MHz	5000MHz	Kit
LQW18AN10NJ10□	10nH ±5%	100MHz	800mA	0.058Ω	38	250MHz	5000MHz	
LQW18AN12NG10□	12nH ±2%	100MHz	750mA	0.071Ω	38	250MHz	5000MHz	Kit
LQW18AN12NJ10□	12nH ±5%	100MHz	750mA	0.071Ω	38	250MHz	5000MHz	
LQW18AN15NJ10□	15nH ±5%	100MHz	700mA	0.085Ω	42	250MHz	4500MHz	
LQW18AN18NG10□	18nH ±2%	100MHz	700mA	0.085Ω	42	250MHz	3500MHz	Kit
LQW18AN18NJ10□	18nH ±5%	100MHz	700mA	0.085Ω	42	250MHz	3500MHz	
LQW18AN22NG10□	22nH ±2%	100MHz	640mA	0.099Ω	42	250MHz	3200MHz	Kit
LQW18AN22NJ10□	22nH ±5%	100MHz	640mA	0.099Ω	42	250MHz	3200MHz	
LQW18AN27NG10□	27nH ±2%	100MHz	590mA	0.116Ω	42	250MHz	2800MHz	Kit
LQW18AN27NJ10□	27nH ±5%	100MHz	590mA	0.116Ω	42	250MHz	2800MHz	
LQW18AN33NJ10□	33nH ±5%	100MHz	550mA	0.132Ω	42	250MHz	2500MHz	

Operating Temperature Range (Self-temperature rise is not included): -55°C~+125°C
For reflow soldering only.

Continued on the following page.

△Note • Please read rating and △CAUTION (for storage, operating, rating, soldering, mounting and handling) in this catalog to prevent smoking and/or burning, etc.
• This catalog has only typical specifications. Therefore, please approve our product specifications or transact the approval sheet for product specifications before ordering.

■ Q-Frequency Characteristics (Typ.)

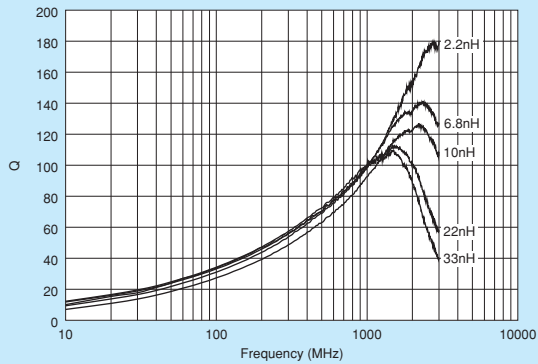

■ Inductance-Frequency Characteristics (Typ.)

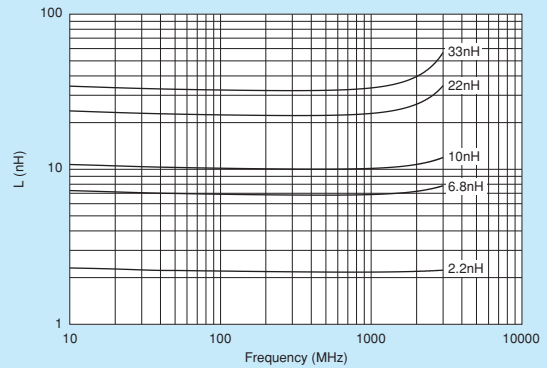

■ Reference Data

LQW18AN_10

4991A&16197A

Part Number	Inductance (nH)	Q (Typ.)				
	Nominal	800MHz	900MHz	1.8GHz	2.0GHz	2.4GHz
LQW18AN2N2□10	2.2	72	75	114	125	134
LQW18AN3N9□10	3.9	75	81	117	120	130
LQW18AN5N6□10	5.6	73	76	109	124	136
LQW18AN6N8□10	6.8	85	91	124	124	131
LQW18AN8N2□10	8.2	86	89	130	152	171
LQW18AN10N□10	10	84	89	117	115	119
LQW18AN12N□10	12	88	95	125	123	128
LQW18AN15N□10	15	81	85	125	149	169
LQW18AN18N□10	18	90	96	112	106	101
LQW18AN22N□10	22	88	93	97	90	80
LQW18AN27N□10	27	83	88	85	77	63
LQW18AN33N□10	33	94	93	107	121	121

△Note • Please read rating and △CAUTION (for storage, operating, rating, soldering, mounting and handling) in this catalog to prevent smoking and/or burning, etc.
 • This catalog has only typical specifications. Therefore, please approve our product specifications or transact the approval sheet for product specifications before ordering.

LQW18AN_80 Series 0603/1608 (inch/mm)

High Frequency Inductors with Low DC Resistance and High Current Capability

■ Appearance/Dimensions

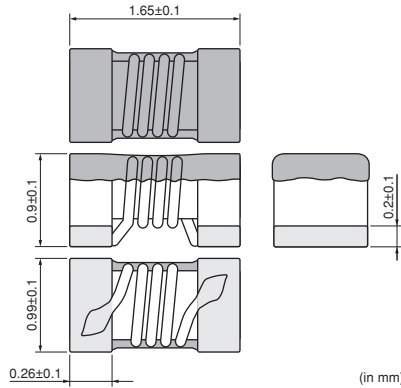

■ Packaging

Code	Packaging	Minimum Quantity
D	ø180mm Paper Taping	4000
J	ø330mm Paper Taping	10000
B	Packing in Bulk	500



Refer to pages 227 to 230 for mounting information.

■ Rated Value (□: packaging code)

Part Number	Inductance	Inductance Test Frequency	Rated Current	Max. of DC Resistance	Q (min.)	Q Test Frequency	Self-Resonance Frequency (min.)	
LQW18AN2N2C80□	2.2nH ±0.2nH	100MHz	3200mA	0.018Ω	24	250MHz	15000MHz	New
LQW18AN2N4C80□	2.4nH ±0.2nH	100MHz	2400mA	0.026Ω	18	250MHz	15000MHz	New
LQW18AN3N0C80□	3.0nH ±0.2nH	100MHz	670mA	0.17Ω	13	250MHz	15000MHz	New
LQW18AN3N9B80□	3.9nH ±0.1nH	100MHz	2200mA	0.028Ω	30	250MHz	10000MHz	New
LQW18AN3N9C80□	3.9nH ±0.2nH	100MHz	2200mA	0.028Ω	30	250MHz	10000MHz	New
LQW18AN4N1B80□	4.1nH ±0.1nH	100MHz	2200mA	0.028Ω	30	250MHz	10000MHz	New
LQW18AN4N1C80□	4.1nH ±0.2nH	100MHz	2200mA	0.028Ω	30	250MHz	10000MHz	New
LQW18AN4N2B80□	4.2nH ±0.1nH	100MHz	2200mA	0.028Ω	30	250MHz	10000MHz	New
LQW18AN4N2C80□	4.2nH ±0.2nH	100MHz	2200mA	0.028Ω	30	250MHz	10000MHz	New
LQW18AN4N3B80□	4.3nH ±0.1nH	100MHz	2100mA	0.036Ω	35	250MHz	11600MHz	New Kit
LQW18AN4N3C80□	4.3nH ±0.2nH	100MHz	2100mA	0.036Ω	35	250MHz	11600MHz	New
LQW18AN4N7B80□	4.7nH ±0.1nH	100MHz	1500mA	0.054Ω	25	250MHz	10400MHz	New Kit
LQW18AN4N7C80□	4.7nH ±0.2nH	100MHz	1500mA	0.054Ω	25	250MHz	10400MHz	New
LQW18AN4N9B80□	4.9nH ±0.1nH	100MHz	1200mA	0.081Ω	23	250MHz	7300MHz	New Kit
LQW18AN4N9C80□	4.9nH ±0.2nH	100MHz	1200mA	0.081Ω	23	250MHz	7300MHz	New
LQW18AN5N6C80□	5.6nH ±0.2nH	100MHz	1900mA	0.04Ω	38	250MHz	6650MHz	New
LQW18AN6N0C80□	6.0nH ±0.2nH	100MHz	1900mA	0.04Ω	40	250MHz	6650MHz	New
LQW18AN6N5C80□	6.5nH ±0.2nH	100MHz	1900mA	0.04Ω	40	250MHz	6650MHz	New
LQW18AN6N8C80□	6.8nH ±0.2nH	100MHz	1900mA	0.04Ω	40	250MHz	6650MHz	New
LQW18AN7N2C80□	7.2nH ±0.2nH	100MHz	1900mA	0.04Ω	38	250MHz	6650MHz	New
LQW18AN7N5C80□	7.5nH ±0.2nH	100MHz	1500mA	0.048Ω	35	250MHz	7000MHz	New
LQW18AN8N2C80□	8.2nH ±0.2nH	100MHz	1600mA	0.052Ω	38	250MHz	4750MHz	New
LQW18AN8N4C80□	8.4nH ±0.2nH	100MHz	1600mA	0.052Ω	38	250MHz	4750MHz	New
LQW18AN8N7C80□	8.7nH ±0.2nH	100MHz	1600mA	0.052Ω	38	250MHz	4750MHz	New
LQW18AN9N1C80□	9.1nH ±0.2nH	100MHz	1600mA	0.052Ω	38	250MHz	4750MHz	New
LQW18AN9N5C80□	9.5nH ±0.2nH	100MHz	1600mA	0.052Ω	38	250MHz	4750MHz	New
LQW18AN9N9C80□	9.9nH ±0.2nH	100MHz	1600mA	0.052Ω	38	250MHz	4750MHz	New
LQW18AN10NG80□	10nH ±2%	100MHz	1600mA	0.052Ω	38	250MHz	4750MHz	New
LQW18AN10NJ80□	10nH ±5%	100MHz	1600mA	0.052Ω	38	250MHz	4750MHz	New
LQW18AN11NG80□	11nH ±2%	100MHz	1600mA	0.052Ω	40	250MHz	4750MHz	New
LQW18AN11NJ80□	11nH ±5%	100MHz	1600mA	0.052Ω	40	250MHz	4750MHz	New
LQW18AN12NG80□	12nH ±2%	100MHz	1500mA	0.064Ω	37	250MHz	5000MHz	New

Operating Temperature Range (Self-temperature rise is not included): -55°C~+125°C
For reflow soldering only.

Continued on the following page.

△Note • Please read rating and △CAUTION (for storage, operating, rating, soldering, mounting and handling) in this catalog to prevent smoking and/or burning, etc.
• This catalog has only typical specifications. Therefore, please approve our product specifications or transact the approval sheet for product specifications before ordering.

Part Number	Inductance	Inductance Test Frequency	Rated Current	Max. of DC Resistance	Q (min.)	Q Test Frequency	Self-Resonance Frequency (min.)	
LQW18AN12NJ80□	12nH ±5%	100MHz	1500mA	0.064Ω	37	250MHz	5000MHz	New
LQW18AN13NG80□	13nH ±2%	100MHz	1500mA	0.064Ω	37	250MHz	5000MHz	New
LQW18AN13NJ80□	13nH ±5%	100MHz	1500mA	0.064Ω	37	250MHz	5000MHz	New
LQW18AN15NG80□	15nH ±2%	100MHz	1400mA	0.075Ω	38	250MHz	4600MHz	New
LQW18AN15NJ80□	15nH ±5%	100MHz	1400mA	0.075Ω	38	250MHz	4600MHz	New
LQW18AN16NG80□	16nH ±2%	100MHz	1400mA	0.075Ω	40	250MHz	4600MHz	New
LQW18AN16NJ80□	16nH ±5%	100MHz	1400mA	0.075Ω	40	250MHz	4600MHz	New
LQW18AN17NG80□	17nH ±2%	100MHz	1400mA	0.075Ω	40	250MHz	4600MHz	New
LQW18AN17NJ80□	17nH ±5%	100MHz	1400mA	0.075Ω	40	250MHz	4600MHz	New
LQW18AN18NG80□	18nH ±2%	100MHz	1400mA	0.075Ω	40	250MHz	4600MHz	New
LQW18AN18NJ80□	18nH ±5%	100MHz	1400mA	0.075Ω	40	250MHz	4600MHz	New
LQW18AN19NG80□	19nH ±2%	100MHz	1400mA	0.075Ω	40	250MHz	4600MHz	New
LQW18AN19NJ80□	19nH ±5%	100MHz	1400mA	0.075Ω	40	250MHz	4600MHz	New
LQW18AN22NG80□	22nH ±2%	100MHz	1300mA	0.086Ω	40	250MHz	3450MHz	New
LQW18AN22NJ80□	22nH ±5%	100MHz	1300mA	0.086Ω	40	250MHz	3450MHz	New
LQW18AN23NG80□	23nH ±2%	100MHz	1300mA	0.086Ω	40	250MHz	3450MHz	New
LQW18AN23NJ80□	23nH ±5%	100MHz	1300mA	0.086Ω	40	250MHz	3450MHz	New
LQW18AN24NG80□	24nH ±2%	100MHz	1300mA	0.086Ω	40	250MHz	3450MHz	New
LQW18AN24NJ80□	24nH ±5%	100MHz	1300mA	0.086Ω	40	250MHz	3450MHz	New
LQW18AN25NG80□	25nH ±2%	100MHz	1200mA	0.098Ω	40	250MHz	3600MHz	New
LQW18AN25NJ80□	25nH ±5%	100MHz	1200mA	0.098Ω	40	250MHz	3600MHz	New
LQW18AN27NG80□	27nH ±2%	100MHz	1200mA	0.098Ω	40	250MHz	3600MHz	New
LQW18AN27NJ80□	27nH ±5%	100MHz	1200mA	0.098Ω	40	250MHz	3600MHz	New
LQW18AN28NG80□	28nH ±2%	100MHz	1200mA	0.098Ω	40	250MHz	3600MHz	New
LQW18AN28NJ80□	28nH ±5%	100MHz	1200mA	0.098Ω	40	250MHz	3600MHz	New
LQW18AN30NG80□	30nH ±2%	100MHz	1100mA	0.12Ω	40	250MHz	2880MHz	New Kit
LQW18AN30NJ80□	30nH ±5%	100MHz	1100mA	0.12Ω	40	250MHz	2880MHz	New
LQW18AN31NG80□	31nH ±2%	100MHz	1100mA	0.11Ω	40	250MHz	3150MHz	New
LQW18AN31NJ80□	31nH ±5%	100MHz	1100mA	0.11Ω	40	250MHz	3150MHz	New
LQW18AN33NG80□	33nH ±2%	100MHz	1100mA	0.11Ω	40	250MHz	3150MHz	New
LQW18AN33NJ80□	33nH ±5%	100MHz	1100mA	0.11Ω	40	250MHz	3150MHz	New
LQW18AN34NG80□	34nH ±2%	100MHz	1050mA	0.15Ω	40	250MHz	3000MHz	New
LQW18AN34NJ80□	34nH ±5%	100MHz	1050mA	0.15Ω	40	250MHz	3000MHz	New
LQW18AN36NG80□	36nH ±2%	100MHz	910mA	0.20Ω	37	250MHz	3000MHz	New Kit
LQW18AN36NJ80□	36nH ±5%	100MHz	910mA	0.20Ω	37	250MHz	3000MHz	New
LQW18AN37NG80□	37nH ±2%	100MHz	910mA	0.20Ω	37	250MHz	3000MHz	New
LQW18AN37NJ80□	37nH ±5%	100MHz	910mA	0.20Ω	37	250MHz	3000MHz	New
LQW18AN39NG80□	39nH ±2%	100MHz	1000mA	0.16Ω	40	250MHz	3280MHz	New Kit
LQW18AN39NJ80□	39nH ±5%	100MHz	1000mA	0.16Ω	40	250MHz	3280MHz	New
LQW18AN41NG80□	41nH ±2%	100MHz	1000mA	0.16Ω	40	250MHz	3280MHz	New
LQW18AN41NJ80□	41nH ±5%	100MHz	1000mA	0.16Ω	40	250MHz	3280MHz	New
LQW18AN43NG80□	43nH ±2%	100MHz	840mA	0.21Ω	40	250MHz	2780MHz	New Kit
LQW18AN43NJ80□	43nH ±5%	100MHz	840mA	0.21Ω	40	250MHz	2780MHz	New
LQW18AN44NG80□	44nH ±2%	100MHz	840mA	0.21Ω	40	250MHz	2780MHz	New
LQW18AN44NJ80□	44nH ±5%	100MHz	840mA	0.21Ω	40	250MHz	2780MHz	New
LQW18AN47NG80□	47nH ±2%	100MHz	830mA	0.23Ω	32	200MHz	2700MHz	New Kit
LQW18AN47NJ80□	47nH ±5%	100MHz	830mA	0.23Ω	32	200MHz	2700MHz	New

Operating Temperature Range (Self-temperature rise is not included): -55°C~+125°C
For reflow soldering only.

Continued on the following page. 

△Note • Please read rating and △CAUTION (for storage, operating, rating, soldering, mounting and handling) in this catalog to prevent smoking and/or burning, etc.
• This catalog has only typical specifications. Therefore, please approve our product specifications or transact the approval sheet for product specifications before ordering.

Part Number	Inductance	Inductance Test Frequency	Rated Current	Max. of DC Resistance	Q (min.)	Q Test Frequency	Self-Resonance Frequency (min.)	
LQW18AN48NG80□	48nH ±2%	100MHz	830mA	0.23Ω	32	200MHz	2700MHz	New
LQW18AN48NJ80□	48nH ±5%	100MHz	830mA	0.23Ω	32	200MHz	2700MHz	New
LQW18AN51NG80□	51nH ±2%	100MHz	830mA	0.23Ω	32	200MHz	2700MHz	New Kit
LQW18AN51NJ80□	51nH ±5%	100MHz	830mA	0.23Ω	32	200MHz	2700MHz	New
LQW18AN52NG80□	52nH ±2%	100MHz	750mA	0.27Ω	35	200MHz	2750MHz	New
LQW18AN52NJ80□	52nH ±5%	100MHz	750mA	0.27Ω	35	200MHz	2750MHz	New
LQW18AN56NG80□	56nH ±2%	100MHz	770mA	0.26Ω	38	200MHz	2600MHz	New Kit
LQW18AN56NJ80□	56nH ±5%	100MHz	770mA	0.26Ω	38	200MHz	2600MHz	New
LQW18AN58NG80□	58nH ±2%	100MHz	700mA	0.30Ω	35	200MHz	2400MHz	New
LQW18AN58NJ80□	58nH ±5%	100MHz	700mA	0.30Ω	35	200MHz	2400MHz	New
LQW18AN68NG80□	68nH ±2%	100MHz	630mA	0.38Ω	37	200MHz	2380MHz	New Kit
LQW18AN68NJ80□	68nH ±5%	100MHz	630mA	0.38Ω	37	200MHz	2380MHz	New
LQW18AN69NG80□	69nH ±2%	100MHz	630mA	0.38Ω	37	200MHz	2380MHz	New
LQW18AN69NJ80□	69nH ±5%	100MHz	630mA	0.38Ω	37	200MHz	2380MHz	New
LQW18AN72NG80□	72nH ±2%	100MHz	560mA	0.47Ω	34	150MHz	2330MHz	New Kit
LQW18AN72NJ80□	72nH ±5%	100MHz	560mA	0.47Ω	34	150MHz	2330MHz	New
LQW18AN73NG80□	73nH ±2%	100MHz	590mA	0.41Ω	28	150MHz	2280MHz	New
LQW18AN73NJ80□	73nH ±5%	100MHz	590mA	0.41Ω	28	150MHz	2280MHz	New
LQW18AN75NG80□	75nH ±2%	100MHz	590mA	0.41Ω	28	150MHz	2280MHz	New Kit
LQW18AN75NJ80□	75nH ±5%	100MHz	590mA	0.41Ω	28	150MHz	2280MHz	New
LQW18AN78NG80□	78nH ±2%	100MHz	590mA	0.41Ω	28	150MHz	2280MHz	New
LQW18AN78NJ80□	78nH ±5%	100MHz	590mA	0.41Ω	28	150MHz	2280MHz	New
LQW18AN82NG80□	82nH ±2%	100MHz	550mA	0.5Ω	34	150MHz	2230MHz	New Kit
LQW18AN82NJ80□	82nH ±5%	100MHz	550mA	0.5Ω	34	150MHz	2230MHz	New
LQW18AN83NG80□	83nH ±2%	100MHz	550mA	0.5Ω	34	150MHz	2230MHz	New
LQW18AN83NJ80□	83nH ±5%	100MHz	550mA	0.5Ω	34	150MHz	2230MHz	New
LQW18AN91NG80□	91nH ±2%	100MHz	520mA	0.54Ω	33	150MHz	1900MHz	New Kit
LQW18AN91NJ80□	91nH ±5%	100MHz	520mA	0.54Ω	33	150MHz	1900MHz	New
LQW18AN94NG80□	94nH ±2%	100MHz	490mA	0.63Ω	34	150MHz	1750MHz	New
LQW18AN94NJ80□	94nH ±5%	100MHz	490mA	0.63Ω	34	150MHz	1750MHz	New
LQW18ANR10G80□	100nH ±2%	100MHz	490mA	0.63Ω	34	150MHz	1750MHz	New Kit
LQW18ANR10J80□	100nH ±5%	100MHz	490mA	0.63Ω	34	150MHz	1750MHz	New
LQW18ANR11G80□	110nH ±2%	100MHz	450mA	0.7Ω	32	150MHz	1730MHz	New Kit
LQW18ANR11J80□	110nH ±5%	100MHz	450mA	0.7Ω	32	150MHz	1730MHz	New
LQW18ANR12G80□	120nH ±2%	100MHz	450mA	0.72Ω	32	150MHz	1650MHz	New Kit
LQW18ANR12J80□	120nH ±5%	100MHz	450mA	0.72Ω	32	150MHz	1650MHz	New
LQW18ANR15G80□	150nH ±2%	100MHz	420mA	0.87Ω	28	150MHz	1580MHz	New Kit
LQW18ANR15J80□	150nH ±5%	100MHz	420mA	0.87Ω	28	150MHz	1580MHz	New
LQW18ANR18G80□	180nH ±2%	100MHz	310mA	1.65Ω	25	100MHz	1380MHz	New Kit
LQW18ANR18J80□	180nH ±5%	100MHz	310mA	1.65Ω	25	100MHz	1380MHz	New
LQW18ANR20G80□	200nH ±2%	100MHz	290mA	1.74Ω	25	100MHz	1350MHz	New Kit
LQW18ANR20J80□	200nH ±5%	100MHz	290mA	1.74Ω	25	100MHz	1350MHz	New
LQW18ANR21G80□	210nH ±2%	100MHz	280mA	1.98Ω	27	100MHz	1330MHz	New Kit
LQW18ANR21J80□	210nH ±5%	100MHz	280mA	1.98Ω	27	100MHz	1330MHz	New
LQW18ANR22G80□	220nH ±2%	100MHz	280mA	2.08Ω	25	100MHz	1330MHz	New Kit
LQW18ANR22J80□	220nH ±5%	100MHz	280mA	2.08Ω	25	100MHz	1330MHz	New
LQW18ANR25G80□	250nH ±2%	100MHz	250mA	2.28Ω	24	100MHz	1330MHz	New Kit

Operating Temperature Range (Self-temperature rise is not included): -55°C~+125°C
For reflow soldering only.

Continued on the following page. 

△Note • Please read rating and △CAUTION (for storage, operating, rating, soldering, mounting and handling) in this catalog to prevent smoking and/or burning, etc.
• This catalog has only typical specifications. Therefore, please approve our product specifications or transact the approval sheet for product specifications before ordering.

Part Number	Inductance	Inductance Test Frequency	Rated Current	Max. of DC Resistance	Q (min.)	Q Test Frequency	Self-Resonance Frequency (min.)	
LQW18ANR25J80□	250nH ±5%	100MHz	250mA	2.28Ω	24	100MHz	1330MHz	New
LQW18ANR27G80□	270nH ±2%	100MHz	260mA	2.42Ω	24	100MHz	1250MHz	New Kit
LQW18ANR27J80□	270nH ±5%	100MHz	260mA	2.42Ω	24	100MHz	1250MHz	New
LQW18ANR30G80□	300nH ±2%	100MHz	220mA	3.12Ω	25	100MHz	1200MHz	New Kit
LQW18ANR30J80□	300nH ±5%	100MHz	220mA	3.12Ω	25	100MHz	1200MHz	New
LQW18ANR33G80□	330nH ±2%	100MHz	190mA	3.84Ω	25	100MHz	1100MHz	New Kit
LQW18ANR33J80□	330nH ±5%	100MHz	190mA	3.84Ω	25	100MHz	1100MHz	New
LQW18ANR36G80□	360nH ±2%	100MHz	190mA	3.98Ω	25	100MHz	1050MHz	New Kit
LQW18ANR36J80□	360nH ±5%	100MHz	190mA	3.98Ω	25	100MHz	1050MHz	New
LQW18ANR39G80□	390nH ±2%	100MHz	190mA	4.23Ω	25	100MHz	1100MHz	New Kit
LQW18ANR39J80□	390nH ±5%	100MHz	190mA	4.23Ω	25	100MHz	1100MHz	New

Operating Temperature Range (Self-temperature rise is not included): -55°C~+125°C
For reflow soldering only.

■ Q-Frequency Characteristics (Typ.)

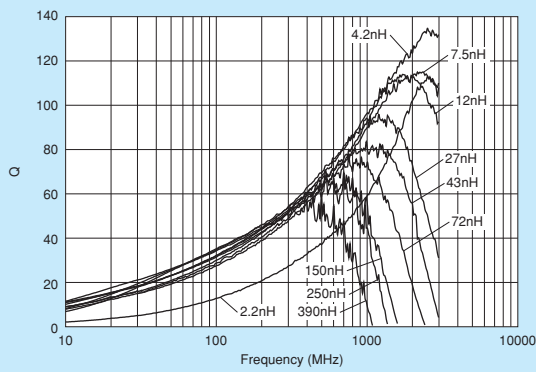

■ Inductance-Frequency Characteristics (Typ.)

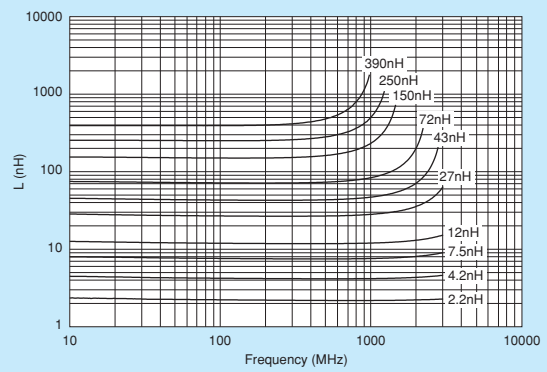

■ Derating of Rated Current

In operating temperature exceeding +85°C, derating of current is necessary for LQW18AN_80 series. Please apply the derating curve shown in chart according to the operating temperature.

Derating of Rated Current

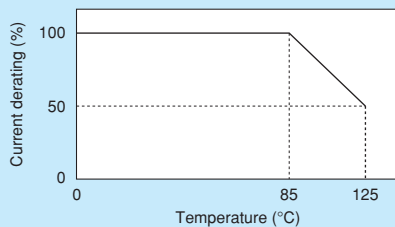

△Note • Please read rating and △CAUTION (for storage, operating, rating, soldering, mounting and handling) in this catalog to prevent smoking and/or burning, etc.
• This catalog has only typical specifications. Therefore, please approve our product specifications or transact the approval sheet for product specifications before ordering.

Wire Wound Type (Non-Magnetic Core)

LQW2BHN_03 Series 0805/2015 (inch/mm)

Size Code 0805 (2015) in inch (in mm), Wound Type

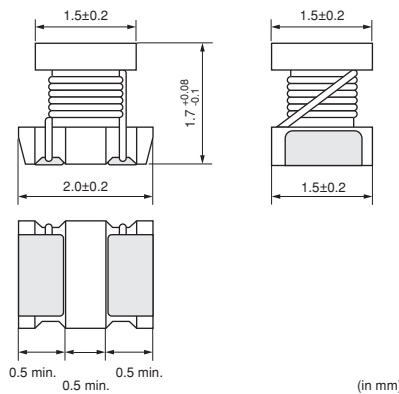
■ Appearance/
Dimensions

■ Packaging

Code	Packaging	Minimum Quantity
L	ø180mm Embossed Taping	2000
K	ø330mm Embossed Taping	7500



Refer to pages 227 to 230 for mounting information.

■ Rated Value (□: packaging code)

Part Number	Inductance	Inductance Test Frequency	Rated Current	Max. of DC Resistance	Q (min.)	Q Test Frequency	Self-Resonance Frequency (min.)	
LQW2BHN3N3D03□	3.3nH ±0.5nH	100MHz	910mA	0.05Ω	10	250MHz	6000MHz	
LQW2BHN6N8D03□	6.8nH ±0.5nH	100MHz	680mA	0.11Ω	20	250MHz	5400MHz	
LQW2BHN8N2D03□	8.2nH ±0.5nH	100MHz	630mA	0.12Ω	20	250MHz	3900MHz	
LQW2BHN10NJ03□	10nH ±5%	100MHz	1320mA	0.03Ω	30	250MHz	3300MHz	
LQW2BHN12NJ03□	12nH ±5%	100MHz	680mA	0.11Ω	30	250MHz	3200MHz	
LQW2BHN15NJ03□	15nH ±5%	100MHz	630mA	0.12Ω	30	250MHz	2700MHz	
LQW2BHN18NJ03□	18nH ±5%	100MHz	690mA	0.10Ω	30	250MHz	2600MHz	
LQW2BHN22NJ03□	22nH ±5%	100MHz	720mA	0.09Ω	30	250MHz	2100MHz	
LQW2BHN27NJ03□	27nH ±5%	100MHz	540mA	0.17Ω	40	250MHz	2300MHz	
LQW2BHN33NG03□	33nH ±2%	100MHz	570mA	0.15Ω	40	250MHz	1900MHz	Kit
LQW2BHN33NJ03□	33nH ±5%	100MHz	570mA	0.15Ω	40	250MHz	1900MHz	
LQW2BHN39NG03□	39nH ±2%	100MHz	730mA	0.09Ω	40	250MHz	1700MHz	Kit
LQW2BHN39NJ03□	39nH ±5%	100MHz	730mA	0.09Ω	40	250MHz	1700MHz	
LQW2BHN47NG03□	47nH ±2%	100MHz	450mA	0.23Ω	40	200MHz	1600MHz	Kit
LQW2BHN47NJ03□	47nH ±5%	100MHz	450mA	0.23Ω	40	200MHz	1600MHz	
LQW2BHN56NG03□	56nH ±2%	100MHz	430mA	0.26Ω	40	200MHz	1500MHz	Kit
LQW2BHN56NJ03□	56nH ±5%	100MHz	430mA	0.26Ω	40	200MHz	1500MHz	
LQW2BHN68NG03□	68nH ±2%	100MHz	460mA	0.23Ω	40	200MHz	1200MHz	Kit
LQW2BHN68NJ03□	68nH ±5%	100MHz	460mA	0.23Ω	40	200MHz	1200MHz	
LQW2BHN82NG03□	82nH ±2%	100MHz	320mA	0.42Ω	40	150MHz	1100MHz	Kit
LQW2BHN82NJ03□	82nH ±5%	100MHz	320mA	0.42Ω	40	150MHz	1100MHz	
LQW2BHNR10G03□	100nH ±2%	100MHz	270mA	0.55Ω	35	150MHz	900MHz	Kit
LQW2BHNR10J03□	100nH ±5%	100MHz	350mA	0.38Ω	40	150MHz	900MHz	
LQW2BHNR12G03□	120nH ±2%	100MHz	320mA	0.40Ω	40	150MHz	750MHz	Kit
LQW2BHNR12J03□	120nH ±5%	100MHz	320mA	0.40Ω	40	150MHz	750MHz	
LQW2BHNR15G03□	150nH ±2%	100MHz	260mA	0.68Ω	30	150MHz	350MHz	Kit
LQW2BHNR15J03□	150nH ±5%	100MHz	390mA	0.47Ω	30	150MHz	350MHz	
LQW2BHNR18G03□	180nH ±2%	100MHz	250mA	0.71Ω	35	100MHz	700MHz	Kit
LQW2BHNR18J03□	180nH ±5%	100MHz	250mA	0.71Ω	35	100MHz	700MHz	
LQW2BHNR22G03□	220nH ±2%	100MHz	240mA	0.70Ω	35	100MHz	500MHz	Kit
LQW2BHNR22J03□	220nH ±5%	100MHz	240mA	0.70Ω	35	100MHz	500MHz	
LQW2BHNR27J03□	270nH ±5%	10MHz	190mA	2.00Ω	15	25.2MHz	550MHz	
LQW2BHNR27K03□	270nH ±10%	10MHz	190mA	2.00Ω	15	25.2MHz	550MHz	Kit

Operating Temperature Range (Self-temperature rise is not included): -40°C~+85°C

Continued on the following page.

△Note • Please read rating and △CAUTION (for storage, operating, rating, soldering, mounting and handling) in this catalog to prevent smoking and/or burning, etc.
• This catalog has only typical specifications. Therefore, please approve our product specifications or transact the approval sheet for product specifications before ordering.

Part Number	Inductance	Inductance Test Frequency	Rated Current	Max. of DC Resistance	Q (min.)	Q Test Frequency	Self-Resonance Frequency (min.)	
LQW2BHNR33J03□	330nH ±5%	10MHz	180mA	2.20Ω	15	25.2MHz	500MHz	
LQW2BHNR33K03□	330nH ±10%	10MHz	180mA	2.20Ω	15	25.2MHz	500MHz	Kit
LQW2BHNR39J03□	390nH ±5%	10MHz	170mA	2.50Ω	15	25.2MHz	400MHz	
LQW2BHNR39K03□	390nH ±10%	10MHz	170mA	2.50Ω	15	25.2MHz	400MHz	Kit
LQW2BHNR47J03□	470nH ±5%	10MHz	160mA	2.80Ω	15	25.2MHz	350MHz	
LQW2BHNR47K03□	470nH ±10%	10MHz	160mA	2.80Ω	15	25.2MHz	350MHz	Kit

Operating Temperature Range (Self-temperature rise is not included): -40°C~+85°C

■ Q-Frequency Characteristics (Typ.)

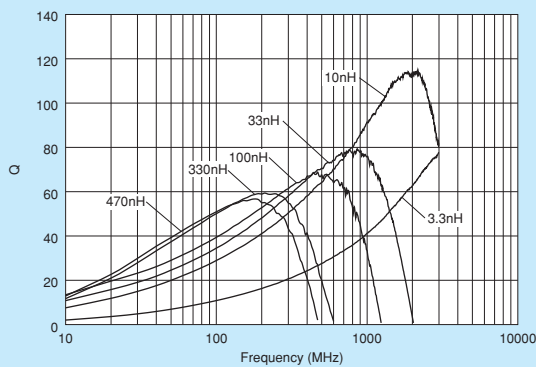

■ Inductance-Frequency Characteristics (Typ.)

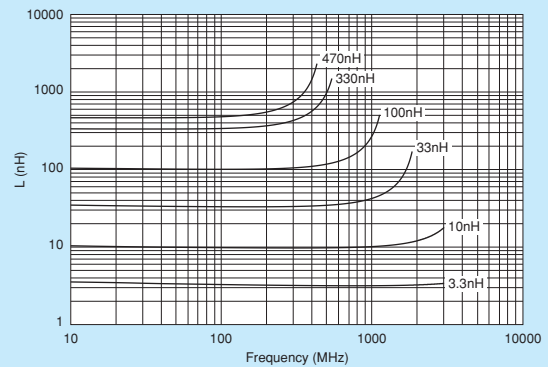

■ Reference Data

LQW2BHN_03

4991A&16197A

Part Number	Inductance (nH)		Q (Typ.)			
	100MHz	800MHz	900MHz	1.8GHz	2.0GHz	2.4GHz
LQW2BHN3N3□03	3.3	55	58	85	88	98
LQW2BHN6N8□03	6.8	51	55	77	78	80
LQW2BHN8N2□03	8.2	60	64	88	88	88
LQW2BHN10N□03	10	81	86	114	110	100
LQW2BHN12N□03	12	77	81	88	83	77
LQW2BHN15N□03	15	76	80	75	66	50
LQW2BHN18N□03	18	81	83	70	58	39
LQW2BHN22N□03	22	85	87	47	31	8
LQW2BHN27N□03	27	77	79	43	28	6
LQW2BHN33N□03	33	76	77	15	1	-
LQW2BHN39N□03	39	83	76	-	-	-
LQW2BHN47N□03	47	70	64	-	-	-
LQW2BHN56N□03	56	73	67	-	-	-
LQW2BHN68N□03	68	62	51	-	-	-
LQW2BHN82N□03	82	64	56	-	-	-
LQW2BHNR10□03	100	50	37	-	-	-
LQW2BHNR12□03	120	31	15	-	-	-
LQW2BHNR15□03	150	21	4	-	-	-
LQW2BHNR18□03	180	1	-	-	-	-
LQW2BHNR22□03	220	-	-	-	-	-
LQW2BHNR27□03	270	-	-	-	-	-
LQW2BHNR33□03	330	-	-	-	-	-
LQW2BHNR39□03	390	-	-	-	-	-
LQW2BHNR47□03	470	-	-	-	-	-

△Note • Please read rating and △CAUTION (for storage, operating, rating, soldering, mounting and handling) in this catalog to prevent smoking and/or burning, etc.
• This catalog has only typical specifications. Therefore, please approve our product specifications or transact the approval sheet for product specifications before ordering.

LQW2BHN_13 Series 0805/2015 (inch/mm)

Size Code 0805 (2015) in inch (in mm), High Q Wound, Low DC Resistance Type

■ Appearance/Dimensions

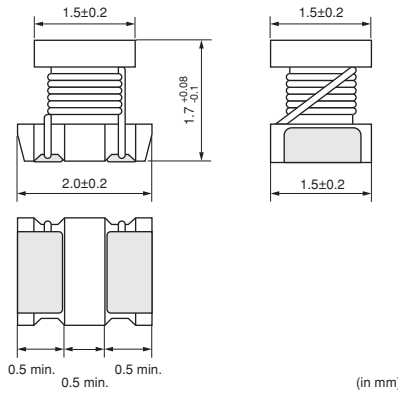

■ Packaging

Code	Packaging	Minimum Quantity
L	ø180mm Embossed Taping	2000
K	ø330mm Embossed Taping	7500



Refer to pages 227 to 230 for mounting information.

■ Rated Value (□: packaging code)

Part Number	Inductance	Inductance Test Frequency	Rated Current	Max. of DC Resistance	Q (min.)	Q Test Frequency	Self-Resonance Frequency (min.)	
LQW2BHN2N7D13□	2.7nH ±0.5nH	100MHz	1900mA	0.02Ω	20	250MHz	6000MHz	Kit
LQW2BHN3N1D13□	3.1nH ±0.5nH	100MHz	1800mA	0.02Ω	20	250MHz	6000MHz	Kit
LQW2BHN3N3D13□	3.3nH ±0.5nH	100MHz	1700mA	0.02Ω	20	250MHz	6000MHz	Kit
LQW2BHN5N6D13□	5.6nH ±0.5nH	100MHz	1500mA	0.02Ω	35	250MHz	6000MHz	Kit
LQW2BHN6N8D13□	6.8nH ±0.5nH	100MHz	1400mA	0.02Ω	35	250MHz	5400MHz	Kit
LQW2BHN8N6D13□	8.6nH ±0.5nH	100MHz	1300mA	0.03Ω	35	250MHz	3900MHz	Kit
LQW2BHN10NJ13□	10nH ±5%	100MHz	1320mA	0.03Ω	35	250MHz	3300MHz	Kit
LQW2BHN12NK13□	12nH ±10%	100MHz	1100mA	0.04Ω	40	250MHz	3200MHz	Kit
LQW2BHN15NK13□	15nH ±10%	100MHz	1000mA	0.04Ω	40	250MHz	3100MHz	Kit
LQW2BHN18NK13□	18.8nH ±10%	100MHz	1000mA	0.05Ω	40	250MHz	2600MHz	Kit
LQW2BHN21NK13□	21nH ±10%	100MHz	950mA	0.05Ω	40	250MHz	2200MHz	Kit
LQW2BHN27NK13□	27nH ±10%	100MHz	900mA	0.06Ω	40	250MHz	1800MHz	Kit

Operating Temperature Range (Self-temperature rise is not included): -40°C~+85°C

■ Q-Frequency Characteristics (Typ.)

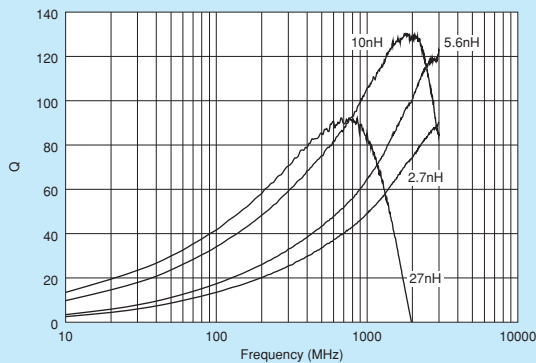

■ Inductance-Frequency Characteristics (Typ.)

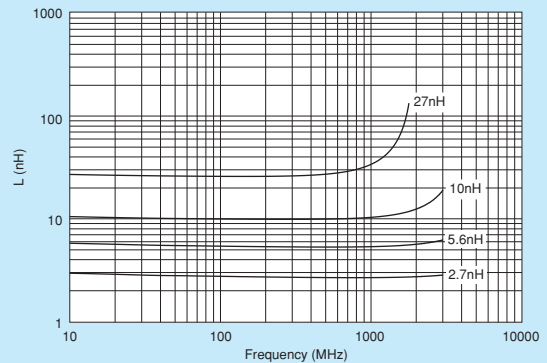

Continued on the following page.

△Note • Please read rating and △CAUTION (for storage, operating, rating, soldering, mounting and handling) in this catalog to prevent smoking and/or burning, etc.
• This catalog has only typical specifications. Therefore, please approve our product specifications or transact the approval sheet for product specifications before ordering.

■ Reference Data

LQW2BHN_13

4991A&16197A

Part Number	Inductance (nH)	Q (Typ.)				
	100MHz	800MHz	900MHz	1.8GHz	2.0GHz	2.4GHz
LQW2BHN2N7□13	2.7	73	77	113	119	128
LQW2BHN3N1□13	3.1	67	72	111	115	126
LQW2BHN3N3□13	3.3	83	90	120	121	138
LQW2BHN5N6□13	5.6	60	82	127	130	142
LQW2BHN6N8□13	6.8	68	72	110	113	120
LQW2BHN8N6□13	8.6	90	100	140	142	135
LQW2BHN10N□13	10	90	95	124	118	106
LQW2BHN12N□13	12	103	107	115	101	76
LQW2BHN15N□13	15	91	94	91	75	49
LQW2BHN18N□13	18.8	105	109	65	44	15
LQW2BHN21N□13	21	98	98	52	31	-
LQW2BHN27N□13	27	87	83	10	-	-

△Note • Please read rating and △CAUTION (for storage, operating, rating, soldering, mounting and handling) in this catalog to prevent smoking and/or burning, etc.
 • This catalog has only typical specifications. Therefore, please approve our product specifications or transact the approval sheet for product specifications before ordering.

LQW2BAS_00 Series 0805/2015 (inch/mm)

Size Code 0805 (2015) in inch (in mm), Horizontal Wound Type

■ Appearance/Dimensions

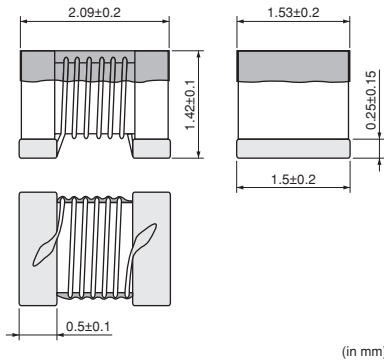

■ Packaging

Code	Packaging	Minimum Quantity
L	ø180mm Embossed Taping	2000



Refer to pages 227 to 230 for mounting information.

■ Rated Value (□: packaging code)

Part Number	Inductance	Inductance Test Frequency	Rated Current	Max. of DC Resistance	Q (min.)	Q Test Frequency	Self-Resonance Frequency (min.)	
LQW2BAS2N8J00□	2.8nH ±5%	250MHz	800mA	0.06Ω	80	1500MHz	12200MHz	Kit
LQW2BAS3N0J00□	3.0nH ±5%	250MHz	800mA	0.06Ω	65	1500MHz	12200MHz	Kit
LQW2BAS5N6J00□	5.6nH ±5%	250MHz	600mA	0.08Ω	65	1000MHz	5900MHz	Kit
LQW2BAS6N8J00□	6.8nH ±5%	250MHz	600mA	0.11Ω	50	1000MHz	5600MHz	Kit
LQW2BAS7N5J00□	7.5nH ±5%	250MHz	600mA	0.14Ω	50	1000MHz	4800MHz	Kit
LQW2BAS8N2J00□	8.2nH ±5%	250MHz	600mA	0.12Ω	50	1000MHz	4400MHz	Kit
LQW2BAS10NJ00□	10nH ±5%	250MHz	600mA	0.10Ω	60	500MHz	4300MHz	Kit
LQW2BAS12NJ00□	12nH ±5%	250MHz	600mA	0.15Ω	50	500MHz	4000MHz	Kit
LQW2BAS15NJ00□	15nH ±5%	250MHz	600mA	0.17Ω	50	500MHz	3200MHz	Kit
LQW2BAS18NJ00□	18nH ±5%	250MHz	600mA	0.20Ω	50	500MHz	3100MHz	Kit
LQW2BAS22NJ00□	22nH ±5%	250MHz	500mA	0.22Ω	55	500MHz	2600MHz	Kit
LQW2BAS24NJ00□	24nH ±5%	250MHz	500mA	0.22Ω	50	500MHz	2400MHz	Kit
LQW2BAS27NJ00□	27nH ±5%	250MHz	500mA	0.25Ω	55	500MHz	2580MHz	Kit
LQW2BAS33NG00□	33nH ±2%	250MHz	500mA	0.27Ω	60	500MHz	2150MHz	Kit
LQW2BAS33NJ00□	33nH ±5%	250MHz	500mA	0.27Ω	60	500MHz	2150MHz	
LQW2BAS36NG00□	36nH ±2%	250MHz	500mA	0.27Ω	55	500MHz	1900MHz	Kit
LQW2BAS36NJ00□	36nH ±5%	250MHz	500mA	0.27Ω	55	500MHz	1900MHz	
LQW2BAS39NG00□	39nH ±2%	250MHz	500mA	0.29Ω	60	500MHz	2000MHz	Kit
LQW2BAS39NJ00□	39nH ±5%	250MHz	500mA	0.29Ω	60	500MHz	2000MHz	
LQW2BAS43NG00□	43nH ±2%	200MHz	500mA	0.34Ω	60	500MHz	1800MHz	Kit
LQW2BAS43NJ00□	43nH ±5%	200MHz	500mA	0.34Ω	60	500MHz	1800MHz	
LQW2BAS47NG00□	47nH ±2%	200MHz	500mA	0.31Ω	60	500MHz	1700MHz	Kit
LQW2BAS47NJ00□	47nH ±5%	200MHz	500mA	0.31Ω	60	500MHz	1700MHz	
LQW2BAS56NG00□	56nH ±2%	200MHz	500mA	0.34Ω	60	500MHz	1600MHz	Kit
LQW2BAS56NJ00□	56nH ±5%	200MHz	500mA	0.34Ω	60	500MHz	1600MHz	
LQW2BAS68NG00□	68nH ±2%	200MHz	500mA	0.38Ω	60	500MHz	1500MHz	Kit
LQW2BAS68NJ00□	68nH ±5%	200MHz	500mA	0.38Ω	60	500MHz	1500MHz	
LQW2BAS82NG00□	82nH ±2%	150MHz	400mA	0.42Ω	65	500MHz	1330MHz	Kit
LQW2BAS82NJ00□	82nH ±5%	150MHz	400mA	0.42Ω	65	500MHz	1330MHz	
LQW2BAS91NG00□	91nH ±2%	150MHz	400mA	0.48Ω	65	500MHz	1330MHz	Kit
LQW2BAS91NJ00□	91nH ±5%	150MHz	400mA	0.48Ω	65	500MHz	1330MHz	
LQW2BASR10G00□	100nH ±2%	150MHz	400mA	0.46Ω	65	500MHz	1250MHz	Kit

Operating Temperature Range (Self-temperature rise is not included): -55°C~+125°C
For reflow soldering only.

Continued on the following page.

△Note • Please read rating and △CAUTION (for storage, operating, rating, soldering, mounting and handling) in this catalog to prevent smoking and/or burning, etc.
• This catalog has only typical specifications. Therefore, please approve our product specifications or transact the approval sheet for product specifications before ordering.

Part Number	Inductance	Inductance Test Frequency	Rated Current	Max. of DC Resistance	Q (min.)	Q Test Frequency	Self-Resonance Frequency (min.)	
LQW2BASR10J00□	100nH ±5%	150MHz	400mA	0.46Ω	65	500MHz	1250MHz	
LQW2BASR11G00□	110nH ±2%	150MHz	400mA	0.48Ω	50	250MHz	1100MHz	Kit
LQW2BASR11J00□	110nH ±5%	150MHz	400mA	0.48Ω	50	250MHz	1100MHz	
LQW2BASR12G00□	120nH ±2%	150MHz	400mA	0.51Ω	50	250MHz	1100MHz	Kit
LQW2BASR12J00□	120nH ±5%	150MHz	400mA	0.51Ω	50	250MHz	1100MHz	
LQW2BASR15G00□	150nH ±2%	100MHz	400mA	0.56Ω	50	250MHz	920MHz	Kit
LQW2BASR15J00□	150nH ±5%	100MHz	400mA	0.56Ω	50	250MHz	920MHz	
LQW2BASR18G00□	180nH ±2%	100MHz	400mA	0.64Ω	50	250MHz	920MHz	Kit
LQW2BASR18J00□	180nH ±5%	100MHz	400mA	0.64Ω	50	250MHz	920MHz	
LQW2BASR22G00□	220nH ±2%	100MHz	400mA	0.70Ω	50	250MHz	820MHz	Kit
LQW2BASR22J00□	220nH ±5%	100MHz	400mA	0.70Ω	50	250MHz	820MHz	
LQW2BASR24G00□	240nH ±2%	100MHz	350mA	1.00Ω	44	250MHz	770MHz	Kit
LQW2BASR24J00□	240nH ±5%	100MHz	350mA	1.00Ω	44	250MHz	770MHz	
LQW2BASR27G00□	270nH ±2%	100MHz	350mA	1.00Ω	48	250MHz	730MHz	Kit
LQW2BASR27J00□	270nH ±5%	100MHz	350mA	1.00Ω	48	250MHz	730MHz	
LQW2BASR33G00□	330nH ±2%	100MHz	310mA	1.40Ω	48	250MHz	650MHz	Kit
LQW2BASR33J00□	330nH ±5%	100MHz	310mA	1.40Ω	48	250MHz	650MHz	
LQW2BASR39J00□	390nH ±5%	100MHz	290mA	1.50Ω	48	250MHz	600MHz	Kit
LQW2BASR47J00□	470nH ±5%	50MHz	250mA	1.76Ω	33	100MHz	300MHz	Kit
LQW2BASR56J00□	560nH ±5%	25MHz	230mA	1.90Ω	23	50MHz	270MHz	Kit
LQW2BASR68J00□	680nH ±5%	25MHz	190mA	2.20Ω	23	50MHz	250MHz	Kit
LQW2BASR82J00□	820nH ±5%	25MHz	180mA	2.35Ω	23	50MHz	230MHz	Kit

Operating Temperature Range (Self-temperature rise is not included): -55°C~+125°C
For reflow soldering only.

■ Q-Frequency Characteristics (Typ.)

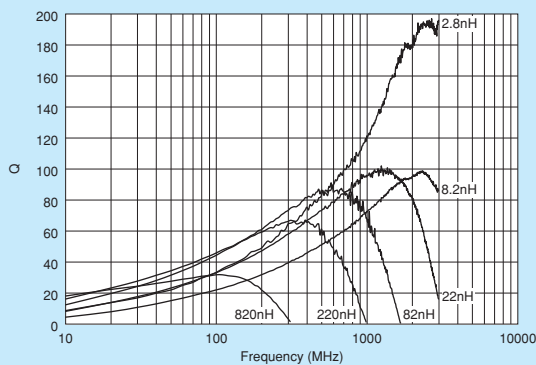

■ Inductance-Frequency Characteristics (Typ.)

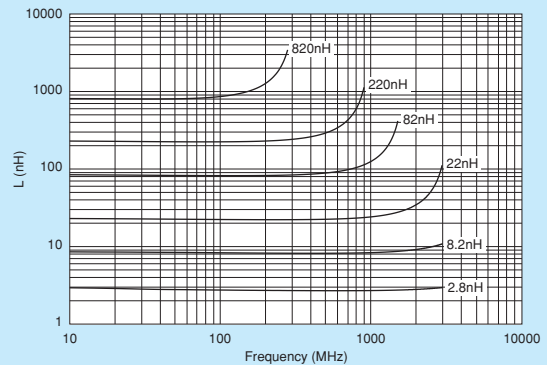

Continued on the following page.

△Note • Please read rating and △CAUTION (for storage, operating, rating, soldering, mounting and handling) in this catalog to prevent smoking and/or burning, etc.
• This catalog has only typical specifications. Therefore, please approve our product specifications or transact the approval sheet for product specifications before ordering.

Reference Data

LQW2BAS_00

4991A&16197A

Part Number	Inductance (nH)			Q (Typ.)		
	100MHz	800MHz	900MHz	1.8GHz	2.0GHz	2.4GHz
LQW2BAS2N8□00	2.8	100	95	170	175	190
LQW2BAS3N0□00	3	63	67	100	104	110
LQW2BAS5N6□00	5.6	96	100	150	153	160
LQW2BAS6N8□00	6.8	77	70	97	100	106
LQW2BAS7N5□00	7.5	66	70	91	90	94
LQW2BAS8N2□00	8.2	64	70	94	94	96
LQW2BAS10N□00	10	96	100	138	140	138
LQW2BAS12N□00	12	73	77	120	103	101
LQW2BAS15N□00	15	78	80	92	80	76
LQW2BAS18N□00	18	84	89	104	100	86
LQW2BAS22N□00	22	91	90	89	80	56
LQW2BAS24N□00	24	87	87	63	51	36
LQW2BAS27N□00	27	90	92	93	89	65
LQW2BAS33N□00	33	92	93	60	45	13
LQW2BAS36N□00	36	92	93	43	26	2
LQW2BAS39N□00	39	96	95	61	41	15
LQW2BAS43N□00	43	95	96	37	17	-
LQW2BAS47N□00	47	91	88	24	5	-
LQW2BAS56N□00	56	92	90	17	-	-
LQW2BAS68N□00	68	91	87	4	-	-
LQW2BAS82N□00	82	85	75	-	-	-
LQW2BAS91N□00	91	83	74	-	-	-
LQW2BASR10□00	100	78	64	-	-	-
LQW2BASR11□00	110	68	50	-	-	-
LQW2BASR12□00	120	48	28	-	-	-
LQW2BASR15□00	150	48	32	-	-	-
LQW2BASR18□00	180	34	20	-	-	-
LQW2BASR22□00	220	29	11	-	-	-
LQW2BASR24□00	240	22	5	-	-	-
LQW2BASR27□00	270	11	-	-	-	-
LQW2BASR33□00	330	4	-	-	-	-
LQW2BASR39□00	390	-	-	-	-	-
LQW2BASR47□00	470	-	-	-	-	-
LQW2BASR56□00	560	-	-	-	-	-
LQW2BASR68□00	680	-	-	-	-	-
LQW2BASR82□00	820	-	-	-	-	-

△Note • Please read rating and △CAUTION (for storage, operating, rating, soldering, mounting and handling) in this catalog to prevent smoking and/or burning, etc.
 • This catalog has only typical specifications. Therefore, please approve our product specifications or transact the approval sheet for product specifications before ordering.

Wire Wound Type (Non-Magnetic Core)

LQW2UAS_00 Series 1008/2520 (inch/mm)

Size Code 1008 (2520) in inch (in mm), Wound Type

■ Appearance/Dimensions

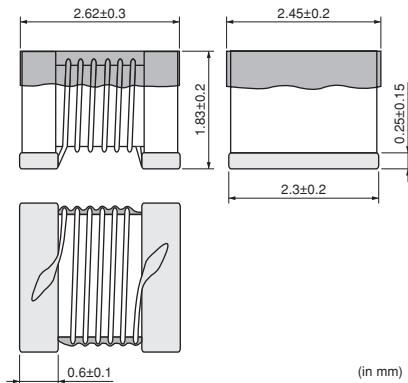

■ Packaging

Code	Packaging	Minimum Quantity
L	ø180mm Embossed Taping	2000



Refer to pages 227 to 230 for mounting information.

■ Rated Value (□: packaging code)

Part Number	Inductance	Inductance Test Frequency	Rated Current	Max. of DC Resistance	Q (min.)	Q Test Frequency	Self-Resonance Frequency (min.)	
LQW2UAS12NG00□	12nH ±2%	50MHz	1000mA	0.09Ω	50	500MHz	3300MHz	Kit
LQW2UAS12NJ00□	12nH ±5%	50MHz	1000mA	0.09Ω	50	500MHz	3300MHz	
LQW2UAS18NG00□	18nH ±2%	50MHz	1000mA	0.11Ω	50	350MHz	2500MHz	Kit
LQW2UAS18NJ00□	18nH ±5%	50MHz	1000mA	0.11Ω	50	350MHz	2500MHz	
LQW2UAS22NG00□	22nH ±2%	50MHz	1000mA	0.12Ω	55	350MHz	2400MHz	Kit
LQW2UAS22NJ00□	22nH ±5%	50MHz	1000mA	0.12Ω	55	350MHz	2400MHz	
LQW2UAS27NG00□	27nH ±2%	50MHz	1000mA	0.13Ω	55	350MHz	1600MHz	Kit
LQW2UAS27NJ00□	27nH ±5%	50MHz	1000mA	0.13Ω	55	350MHz	1600MHz	
LQW2UAS33NG00□	33nH ±2%	50MHz	1000mA	0.14Ω	60	350MHz	1600MHz	Kit
LQW2UAS33NJ00□	33nH ±5%	50MHz	1000mA	0.14Ω	60	350MHz	1600MHz	
LQW2UAS39NG00□	39nH ±2%	50MHz	1000mA	0.15Ω	60	350MHz	1500MHz	Kit
LQW2UAS39NJ00□	39nH ±5%	50MHz	1000mA	0.15Ω	60	350MHz	1500MHz	
LQW2UAS47NG00□	47nH ±2%	50MHz	1000mA	0.16Ω	65	350MHz	1500MHz	Kit
LQW2UAS47NJ00□	47nH ±5%	50MHz	1000mA	0.16Ω	65	350MHz	1500MHz	
LQW2UAS56NG00□	56nH ±2%	50MHz	1000mA	0.18Ω	65	350MHz	1300MHz	Kit
LQW2UAS56NJ00□	56nH ±5%	50MHz	1000mA	0.18Ω	65	350MHz	1300MHz	
LQW2UAS68NG00□	68nH ±2%	50MHz	1000mA	0.2Ω	65	350MHz	1300MHz	Kit
LQW2UAS68NJ00□	68nH ±5%	50MHz	1000mA	0.2Ω	65	350MHz	1300MHz	
LQW2UAS82NG00□	82nH ±2%	50MHz	1000mA	0.22Ω	60	350MHz	1000MHz	Kit
LQW2UAS82NJ00□	82nH ±5%	50MHz	1000mA	0.22Ω	60	350MHz	1000MHz	
LQW2UASR10G00□	100nH ±2%	25MHz	650mA	0.56Ω	60	350MHz	1000MHz	Kit
LQW2UASR10J00□	100nH ±5%	25MHz	650mA	0.56Ω	60	350MHz	1000MHz	
LQW2UASR12G00□	120nH ±2%	25MHz	650mA	0.63Ω	60	350MHz	950MHz	Kit
LQW2UASR12J00□	120nH ±5%	25MHz	650mA	0.63Ω	60	350MHz	950MHz	
LQW2UASR15G00□	150nH ±2%	25MHz	580mA	0.7Ω	45	100MHz	850MHz	Kit
LQW2UASR15J00□	150nH ±5%	25MHz	580mA	0.7Ω	45	100MHz	850MHz	
LQW2UASR18G00□	180nH ±2%	25MHz	620mA	0.77Ω	45	100MHz	750MHz	Kit
LQW2UASR18J00□	180nH ±5%	25MHz	620mA	0.77Ω	45	100MHz	750MHz	
LQW2UASR22G00□	220nH ±2%	25MHz	500mA	0.84Ω	45	100MHz	700MHz	Kit
LQW2UASR22J00□	220nH ±5%	25MHz	500mA	0.84Ω	45	100MHz	700MHz	
LQW2UASR27G00□	270nH ±2%	25MHz	500mA	0.91Ω	45	100MHz	600MHz	Kit
LQW2UASR27J00□	270nH ±5%	25MHz	500mA	0.91Ω	45	100MHz	600MHz	

Operating Temperature Range (Self-temperature rise is not included): -55°C~+125°C
For reflow soldering only.

Continued on the following page.

△Note • Please read rating and △CAUTION (for storage, operating, rating, soldering, mounting and handling) in this catalog to prevent smoking and/or burning, etc.
• This catalog has only typical specifications. Therefore, please approve our product specifications or transact the approval sheet for product specifications before ordering.

Inductors for Power Lines

Inductors for General Use

RF Inductors
Wire Wound Type (Non-Magnetic Core)

Part Number	Inductance	Inductance Test Frequency	Rated Current	Max. of DC Resistance	Q (min.)	Q Test Frequency	Self-Resonance Frequency (min.)	
LQW2UASR33G00□	330nH ±2%	25MHz	450mA	1.05Ω	45	100MHz	570MHz	Kit
LQW2UASR33J00□	330nH ±5%	25MHz	450mA	1.05Ω	45	100MHz	570MHz	
LQW2UASR39G00□	390nH ±2%	25MHz	470mA	1.12Ω	45	100MHz	500MHz	Kit
LQW2UASR39J00□	390nH ±5%	25MHz	470mA	1.12Ω	45	100MHz	500MHz	
LQW2UASR47G00□	470nH ±2%	25MHz	470mA	1.19Ω	45	100MHz	450MHz	Kit
LQW2UASR47J00□	470nH ±5%	25MHz	470mA	1.19Ω	45	100MHz	450MHz	
LQW2UASR56G00□	560nH ±2%	25MHz	400mA	1.33Ω	45	100MHz	415MHz	Kit
LQW2UASR56J00□	560nH ±5%	25MHz	400mA	1.33Ω	45	100MHz	415MHz	
LQW2UASR62G00□	620nH ±2%	25MHz	300mA	1.4Ω	45	100MHz	375MHz	Kit
LQW2UASR62J00□	620nH ±5%	25MHz	300mA	1.4Ω	45	100MHz	375MHz	
LQW2UASR68G00□	680nH ±2%	25MHz	400mA	1.47Ω	45	100MHz	375MHz	Kit
LQW2UASR68J00□	680nH ±5%	25MHz	400mA	1.47Ω	45	100MHz	375MHz	
LQW2UASR75G00□	750nH ±2%	25MHz	360mA	1.54Ω	45	100MHz	360MHz	Kit
LQW2UASR75J00□	750nH ±5%	25MHz	360mA	1.54Ω	45	100MHz	360MHz	
LQW2UASR82G00□	820nH ±2%	25MHz	400mA	1.61Ω	45	100MHz	350MHz	Kit
LQW2UASR82J00□	820nH ±5%	25MHz	400mA	1.61Ω	45	100MHz	350MHz	
LQW2UASR91G00□	910nH ±2%	25MHz	380mA	1.68Ω	35	50MHz	320MHz	Kit
LQW2UASR91J00□	910nH ±5%	25MHz	380mA	1.68Ω	35	50MHz	320MHz	
LQW2UAS1R0G00□	1000nH ±2%	25MHz	370mA	1.75Ω	35	50MHz	290MHz	Kit
LQW2UAS1R0J00□	1000nH ±5%	25MHz	370mA	1.75Ω	35	50MHz	290MHz	
LQW2UAS1R2J00□	1200nH ±5%	7.9MHz	310mA	2.0Ω	35	50MHz	210MHz	Kit
LQW2UAS1R5J00□	1500nH ±5%	7.9MHz	330mA	2.3Ω	28	50MHz	120MHz	Kit
LQW2UAS1R8J00□	1800nH ±5%	7.9MHz	300mA	2.6Ω	28	50MHz	140MHz	Kit
LQW2UAS2R2J00□	2200nH ±5%	7.9MHz	280mA	2.8Ω	28	50MHz	130MHz	Kit
LQW2UAS2R7J00□	2700nH ±5%	7.9MHz	290mA	3.2Ω	22	25MHz	110MHz	Kit
LQW2UAS3R3J00□	3300nH ±5%	7.9MHz	290mA	3.4Ω	22	25MHz	90MHz	Kit
LQW2UAS3R9J00□	3900nH ±5%	7.9MHz	260mA	3.6Ω	20	25MHz	70MHz	Kit
LQW2UAS4R7J00□	4700nH ±5%	7.9MHz	260mA	4.0Ω	20	25MHz	60MHz	Kit

Operating Temperature Range (Self-temperature rise is not included): -55°C~+125°C
 For reflow soldering only.

■ Q-Frequency Characteristics (Typ.)

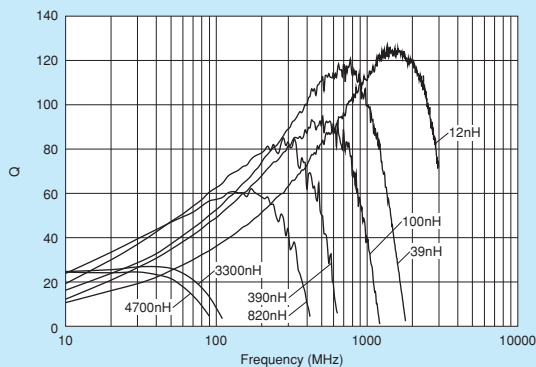

■ Inductance-Frequency Characteristics (Typ.)

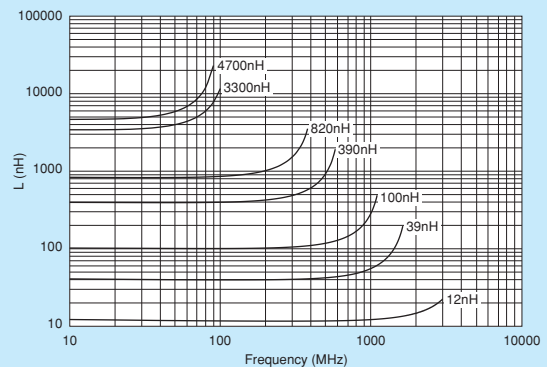

Continued on the following page.

⚠Note • Please read rating and ⚠CAUTION (for storage, operating, rating, soldering, mounting and handling) in this catalog to prevent smoking and/or burning, etc.
 • This catalog has only typical specifications. Therefore, please approve our product specifications or transact the approval sheet for product specifications before ordering.

Reference Data

LQW2UAS_00

4991A&16197A

Part Number	Inductance (nH)			Q (Typ.)		
	100MHz	800MHz	900MHz	1.8GHz	2.0GHz	2.4GHz
LQW2UAS12N□00	12	108	114	125	120	110
LQW2UAS18N□00	18	123	130	123	118	90
LQW2UAS22N□00	22	120	122	94	73	43
LQW2UAS27N□00	27	103	103	34	14	-
LQW2UAS33N□00	33	122	125	67	41	-
LQW2UAS39N□00	39	115	110	9	-	-
LQW2UAS47N□00	47	120	125	19	-	-
LQW2UAS56N□00	56	111	98	-	-	-
LQW2UAS68N□00	68	110	100	-	-	-
LQW2UAS82N□00	82	75	60	-	-	-
LQW2UASR10□00	100	70	57	-	-	-
LQW2UASR12□00	120	67	50	-	-	-
LQW2UASR15□00	150	47	25	-	-	-
LQW2UASR18□00	180	27	5	-	-	-
LQW2UASR22□00	220	7	-	-	-	-
LQW2UASR27□00	270	-	-	-	-	-
LQW2UASR33□00	330	-	-	-	-	-
LQW2UASR39□00	390	-	-	-	-	-
LQW2UASR47□00	470	-	-	-	-	-
LQW2UASR56□00	560	-	-	-	-	-
LQW2UASR62□00	620	-	-	-	-	-
LQW2UASR68□00	680	-	-	-	-	-
LQW2UASR75□00	750	-	-	-	-	-
LQW2UASR82□00	820	-	-	-	-	-
LQW2UASR91□00	910	-	-	-	-	-
LQW2UAS1R0□00	1000	-	-	-	-	-
LQW2UAS1R2□00	1200	-	-	-	-	-
LQW2UAS1R5□00	1500	-	-	-	-	-
LQW2UAS1R8□00	1800	-	-	-	-	-
LQW2UAS2R2□00	2200	-	-	-	-	-
LQW2UAS2R7□00	2700	-	-	-	-	-
LQW2UAS3R3□00	3300	-	-	-	-	-
LQW2UAS3R9□00	3900	-	-	-	-	-
LQW2UAS4R7□00	4700	-	-	-	-	-

△Note • Please read rating and △CAUTION (for storage, operating, rating, soldering, mounting and handling) in this catalog to prevent smoking and/or burning, etc.
 • This catalog has only typical specifications. Therefore, please approve our product specifications or transact the approval sheet for product specifications before ordering.

LQW31HN_03 Series 1206/3216 (inch/mm)

Size Code 1206 (3216) in inch (in mm), Wound Type

■ Appearance/Dimensions

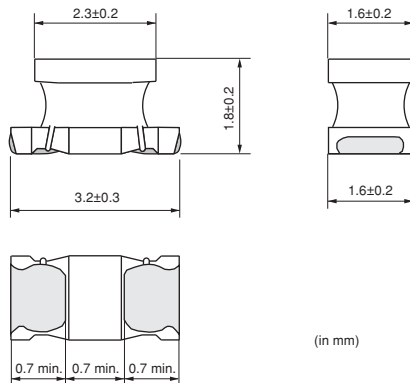

■ Packaging

Code	Packaging	Minimum Quantity
L	ø180mm Embossed Taping	2000
K	ø330mm Embossed Taping	7500



Refer to pages 227 to 230 for mounting information.

■ Rated Value (□: packaging code)

Part Number	Inductance	Inductance Test Frequency	Rated Current	DC Resistance	Q (min.)	Q Test Frequency	Self-Resonance Frequency (min.)
LQW31HN8N8J03□	8.8nH ±5%	100MHz	750mA	0.029Ω ±40%	50	436MHz	1000MHz
LQW31HN8N8K03□	8.8nH ±10%	100MHz	750mA	0.029Ω ±40%	50	436MHz	1000MHz
LQW31HN15NJ03□	14.7nH ±5%	100MHz	680mA	0.035Ω ±40%	60	436MHz	1000MHz
LQW31HN15NK03□	14.7nH ±10%	100MHz	680mA	0.035Ω ±40%	60	436MHz	1000MHz
LQW31HN17NJ03□	17nH ±5%	100MHz	650mA	0.037Ω ±40%	60	436MHz	1000MHz
LQW31HN17NK03□	17nH ±10%	100MHz	650mA	0.037Ω ±40%	60	436MHz	1000MHz
LQW31HN23NJ03□	23nH ±5%	100MHz	590mA	0.046Ω ±40%	60	436MHz	1000MHz
LQW31HN23NK03□	23nH ±10%	100MHz	590mA	0.046Ω ±40%	60	436MHz	1000MHz
LQW31HN27NJ03□	27nH ±5%	100MHz	560mA	0.051Ω ±40%	60	436MHz	1000MHz
LQW31HN27NK03□	27nH ±10%	100MHz	560mA	0.051Ω ±40%	60	436MHz	1000MHz
LQW31HN33NJ03□	33nH ±5%	100MHz	530mA	0.057Ω ±40%	60	436MHz	1000MHz
LQW31HN33NK03□	33nH ±10%	100MHz	530mA	0.057Ω ±40%	60	436MHz	1000MHz
LQW31HN39NJ03□	39nH ±5%	100MHz	490mA	0.067Ω ±40%	60	436MHz	1000MHz
LQW31HN39NK03□	39nH ±10%	100MHz	490mA	0.067Ω ±40%	60	436MHz	1000MHz
LQW31HN47NJ03□	47nH ±5%	100MHz	380mA	0.11Ω ±40%	60	436MHz	1000MHz
LQW31HN47NK03□	47nH ±10%	100MHz	380mA	0.11Ω ±40%	60	436MHz	1000MHz
LQW31HN56NJ03□	56nH ±5%	100MHz	330mA	0.14Ω ±40%	60	436MHz	1000MHz
LQW31HN56NK03□	56nH ±10%	100MHz	330mA	0.14Ω ±40%	60	436MHz	1000MHz
LQW31HN64NJ03□	64nH ±5%	100MHz	290mA	0.18Ω ±40%	60	436MHz	1000MHz
LQW31HN64NK03□	64nH ±10%	100MHz	290mA	0.18Ω ±40%	60	436MHz	1000MHz
LQW31HN84NJ03□	84nH ±5%	100MHz	240mA	0.28Ω ±40%	60	436MHz	1000MHz
LQW31HN84NK03□	84nH ±10%	100MHz	240mA	0.28Ω ±40%	60	436MHz	1000MHz
LQW31HNR10J03□	100nH ±5%	100MHz	230mA	0.3Ω ±40%	60	436MHz	900MHz
LQW31HNR10K03□	100nH ±10%	100MHz	230mA	0.3Ω ±40%	60	436MHz	900MHz

Operating Temperature Range (Self-temperature rise is not included): -40°C~+85°C

Continued on the following page. ↗

△Note • Please read rating and △CAUTION (for storage, operating, rating, soldering, mounting and handling) in this catalog to prevent smoking and/or burning, etc.
• This catalog has only typical specifications. Therefore, please approve our product specifications or transact the approval sheet for product specifications before ordering.

■ Q-Frequency Characteristics (Typ.)

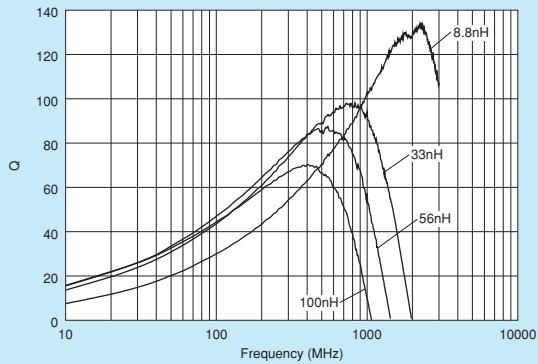

■ Inductance-Frequency Characteristics (Typ.)

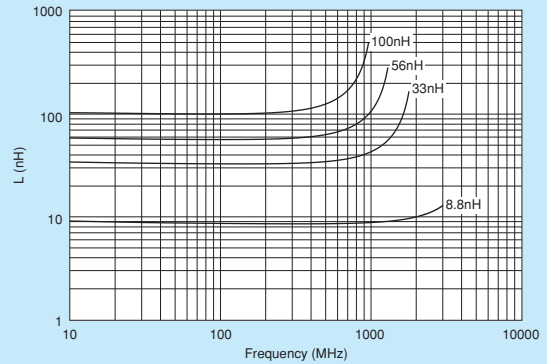

■ Reference Data

LQW31HN_03

4991A&16197A

Part Number	Inductance (nH)		Q (Typ.)			
	100MHz	800MHz	900MHz	1.8GHz	2.0GHz	2.4GHz
LQW31HN8N8□03	8.8	101	107	146	146	157
LQW31HN15N□03	14.7	105	108	92	75	50
LQW31HN17N□03	17	106	108	66	47	22
LQW31HN23N□03	23	109	109	53	32	-
LQW31HN27N□03	27	106	109	37	14	-
LQW31HN33N□03	33	98	96	5	-	-
LQW31HN39N□03	39	90	88	-	-	-
LQW31HN47N□03	47	80	72	-	-	-
LQW31HN56N□03	56	77	67	-	-	-
LQW31HN64N□03	64	73	61	-	-	-
LQW31HN84N□03	84	59	47	-	-	-
LQW31HNR10□03	100	40	25	-	-	-

△Note • Please read rating and △CAUTION (for storage, operating, rating, soldering, mounting and handling) in this catalog to prevent smoking and/or burning, etc.
 • This catalog has only typical specifications. Therefore, please approve our product specifications or transact the approval sheet for product specifications before ordering.

Inductors for Power Lines
 Inductors for General Use
 RF Inductors
 Wire Wound Type (Non-Magnetic Core)

LQW21HN_00 Series 0805/2012 (inch/mm)

Size Code 0805 (2012) in inch (in mm), Ferrite Core High Frequency Wound Type

■ Appearance/ Dimensions

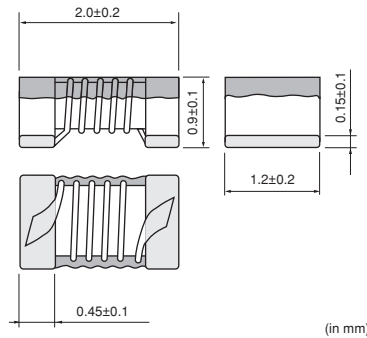

(in mm)

■ Packaging

Code	Packaging	Minimum Quantity
L	ø180mm Embossed Taping	3000
B	Packing in Bulk	500



Refer to pages 227 to 230 for mounting information.

■ Rated Value (□: packaging code)

Part Number	Inductance	Inductance Test Frequency	Rated Current	Max. of DC Resistance	Q (min.)	Q Test Frequency	Self-Resonance Frequency (min.)	
LQW21HNR47J00□	0.47μH ±5%	10MHz	160mA	1.30Ω	35	100MHz	620MHz	Kit
LQW21HNR56J00□	0.56μH ±5%	10MHz	150mA	1.43Ω	35	100MHz	580MHz	Kit
LQW21HNR68J00□	0.68μH ±5%	10MHz	130mA	2.21Ω	35	100MHz	520MHz	Kit
LQW21HNR82J00□	0.82μH ±5%	10MHz	125mA	2.34Ω	35	100MHz	480MHz	Kit
LQW21HN1R0J00□	1.0μH ±5%	10MHz	115mA	2.86Ω	35	100MHz	450MHz	Kit
LQW21HN1R2J00□	1.2μH ±5%	10MHz	100mA	3.12Ω	35	100MHz	400MHz	Kit
LQW21HN1R5J00□	1.5μH ±5%	10MHz	85mA	5.33Ω	35	100MHz	350MHz	Kit
LQW21HN1R8J00□	1.8μH ±5%	10MHz	80mA	5.85Ω	35	100MHz	320MHz	Kit
LQW21HN2R2J00□	2.2μH ±5%	10MHz	75mA	6.50Ω	35	100MHz	300MHz	Kit

Operating Temperature Range (Self-temperature rise is not included): -40°C~+85°C
For reflow soldering only.

■ Q-Frequency Characteristics (Typ.)

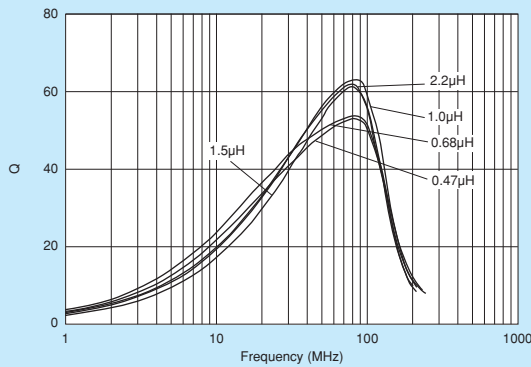

■ Inductance-Frequency Characteristics (Typ.)

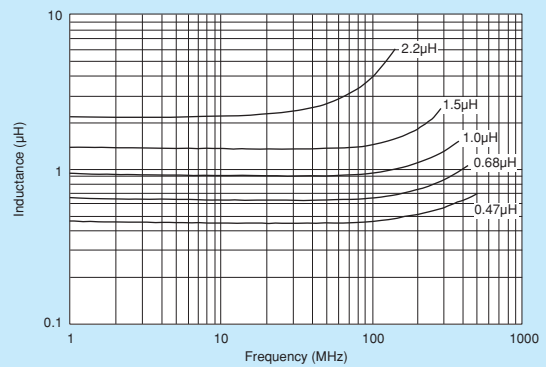

Continued on the following page.

△Note • Please read rating and △CAUTION (for storage, operating, rating, soldering, mounting and handling) in this catalog to prevent smoking and/or burning, etc.
• This catalog has only typical specifications. Therefore, please approve our product specifications or transact the approval sheet for product specifications before ordering.

Reference Data

LQW21HN_00

4991A&16197A

Part Number	Inductance (μ H)	Q (Typ.)				
		100MHz	30MHz	70MHz	80MHz	90MHz
LQW21HNR47□00	0.47	40	54	55	56	55
LQW21HNR56□00	0.56	46	63	64	64	60
LQW21HNR68□00	0.68	41	56	56	57	54
LQW21HNR82□00	0.82	41	57	58	59	57
LQW21HN1R0□00	1.0	44	54	54	54	50
LQW21HN1R2□00	1.2	44	57	58	58	52
LQW21HN1R5□00	1.5	39	56	56	56	53
LQW21HN1R8□00	1.8	41	56	55	54	50
LQW21HN2R2□00	2.2	43	57	55	55	50

△Note • Please read rating and △CAUTION (for storage, operating, rating, soldering, mounting and handling) in this catalog to prevent smoking and/or burning, etc.
 • This catalog has only typical specifications. Therefore, please approve our product specifications or transact the approval sheet for product specifications before ordering.

LQH31HN_03 Series 1206/3216 (inch/mm)

Size Code 1206 (3216) in inch (in mm), Ferrite Core High Frequency Wound Type

■ Appearance/Dimensions

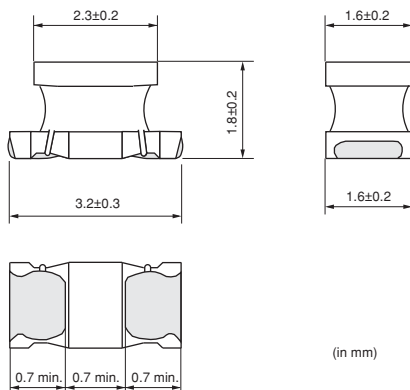

■ Packaging

Code	Packaging	Minimum Quantity
L	ø180mm Embossed Taping	2000
K	ø330mm Embossed Taping	7500



Refer to pages 227 to 230 for mounting information.

■ Rated Value (□: packaging code)

Part Number	Inductance	Inductance Test Frequency	Rated Current	DC Resistance	Q (min.)	Q Test Frequency	Self-Resonance Frequency (min.)
LQH31HN54NK03□	54nH ±10%	1MHz	920mA	0.035Ω ±30%	50	100MHz	800MHz
LQH31HN95NK03□	95nH ±10%	1MHz	790mA	0.047Ω ±30%	60	100MHz	650MHz
LQH31HNR14J03□	145nH ±5%	1MHz	700mA	0.061Ω ±30%	60	100MHz	500MHz
LQH31HNR14K03□	145nH ±10%	1MHz	700mA	0.061Ω ±30%	60	100MHz	500MHz
LQH31HNR21J03□	215nH ±5%	1MHz	520mA	0.11Ω ±30%	60	100MHz	430MHz
LQH31HNR21K03□	215nH ±10%	1MHz	520mA	0.11Ω ±30%	60	100MHz	430MHz
LQH31HNR29J03□	290nH ±5%	1MHz	420mA	0.17Ω ±30%	60	100MHz	360MHz
LQH31HNR29K03□	290nH ±10%	1MHz	420mA	0.17Ω ±30%	60	100MHz	360MHz
LQH31HNR39J03□	390nH ±5%	1MHz	330mA	0.26Ω ±30%	60	100MHz	300MHz
LQH31HNR39K03□	390nH ±10%	1MHz	330mA	0.26Ω ±30%	60	100MHz	300MHz
LQH31HNR50J03□	500nH ±5%	1MHz	260mA	0.44Ω ±30%	60	100MHz	270MHz
LQH31HNR50K03□	500nH ±10%	1MHz	260mA	0.44Ω ±30%	60	100MHz	270MHz
LQH31HNR61J03□	610nH ±5%	1MHz	250mA	0.48Ω ±30%	60	100MHz	240MHz
LQH31HNR61K03□	610nH ±10%	1MHz	250mA	0.48Ω ±30%	60	100MHz	240MHz
LQH31HNR75J03□	750nH ±5%	1MHz	190mA	0.79Ω ±30%	60	100MHz	220MHz
LQH31HNR75K03□	750nH ±10%	1MHz	190mA	0.79Ω ±30%	60	100MHz	220MHz
LQH31HNR88J03□	880nH ±5%	1MHz	180mA	0.86Ω ±30%	60	100MHz	200MHz
LQH31HNR88K03□	880nH ±10%	1MHz	180mA	0.86Ω ±30%	60	100MHz	200MHz

Operating Temperature Range (Self-temperature rise is not included): -40°C~+85°C

■ Q-Frequency Characteristics (Typ.)

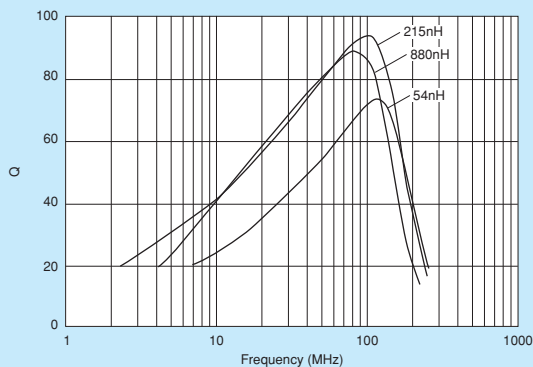

Continued on the following page.

△Note • Please read rating and △CAUTION (for storage, operating, rating, soldering, mounting and handling) in this catalog to prevent smoking and/or burning, etc.
• This catalog has only typical specifications. Therefore, please approve our product specifications or transact the approval sheet for product specifications before ordering.

Reference Data

LQH31HN_03

4991A&16197A

Part Number	Inductance (nH)	Q (Typ.)				
	100MHz	800MHz	900MHz	1.8GHz	2.0GHz	2.4GHz
LQH31HN54N□03	54	2	1	-	-	-
LQH31HN95N□03	95	1	-	-	-	-
LQH31HNR14□03	145	-	-	-	-	-
LQH31HNR21□03	215	-	-	-	-	-
LQH31HNR29□03	290	-	-	-	-	-
LQH31HNR39□03	390	-	-	-	-	-
LQH31HNR50□03	500	-	-	-	-	-
LQH31HNR61□03	610	-	-	-	-	-
LQH31HNR75□03	750	-	-	-	-	-
LQH31HNR88□03	880	-	-	-	-	-

△Note • Please read rating and △CAUTION (for storage, operating, rating, soldering, mounting and handling) in this catalog to prevent smoking and/or burning, etc.
 • This catalog has only typical specifications. Therefore, please approve our product specifications or transact the approval sheet for product specifications before ordering.

⚠Caution

● Rating

1. About the Rated Current

Do not use products beyond the rated current as this may create excessive heat and deteriorate the insulation resistance.

2. About Excessive Surge Current

Surge current (pulse current or rush current) greater than the specified rated current applied to the product may cause a critical failure, such as an open circuit, burnout caused by excessive temperature rise. Please contact us in advance in case of applying the surge current.

Notice

● Storage and Operating Condition

<Operating Environment>

Do not use products in chemical atmosphere such as chlorine gas, acid or sulfide gas.

<Storage Requirements>

1. Storage Period

LQG series should be used within 6 months; the other products should be used within 12 months. Check solderability if this period is exceeded.

2. Storage Conditions

(1) Store products in a warehouse in compliance with the following conditions:

Temperature: -10 to +40 degrees C.

Humidity: 15 to 85% (relative humidity)

Do not subject products to rapid changes in temperature and humidity.

Do not store them in chemical atmosphere such as one containing sulfurous acid gas or alkaline gas.

This will prevent electrode oxidation, which causes poor solderability and possible corrosion of inductors.

(2) Do not store products in bulk packaging to prevent collision among inductors, which causes core chipping and wire breakage.

(3) Store products on pallets to protect from humidity, dust, etc.

(4) Avoid heat shock, vibration, direct sunlight, etc.

● Handling

This item is designed to have sufficient strength, but handle with care to avoid chipping or breaking its ceramic structure.

LQW_A/LQW_H series

- To prevent breaking the wire, avoid touching with sharp material, such as tweezers or the bristles of a cleaning brush, to the wire wound portion.

- To prevent breaking the core, avoid applying excessive mechanical shock to products mounted on the board.

- In some mounting machines, when picking up components, a support pin pushes the components up from the bottom of the base tape. In this case, please remove the support pin. The support pin may damage the components and break the wire.

- In rare cases, the laser recognition cannot recognize this component. Please contact us when you use laser recognition. (There is no problem with the permeation and reflection type.)

LQH_H series

- To prevent breaking the wire, avoid touching with sharp material, such as tweezers or the bristles of a cleaning brush, to the wire wound portion of this product.

- To prevent breaking the core, avoid applying excessive mechanical shock to products mounted on the board.

LQG,LQP series (except LQP02T_02/LQP03T_02)

- The pattern of the chip Inductors is covered with protective film. Take care to avoid damaging the chip Inductors when handling it with pick-up nozzles, sharp instruments, etc.

<Handling>

1. Avoid applying excessive stress to products to prevent damage.



2. Do not touch wire wound with sharp objects such as tweezers to prevent wire breakage.

3. Do not apply excessive force to products mounted on boards to prevent core breakage.

<Transportation>

Do not apply excessive vibration or mechanical shock to products.

Continued on the following page. 

 Note • Please read rating and  CAUTION (for storage, operating, rating, soldering, mounting and handling) in this catalog to prevent smoking and/or burning, etc.
• This catalog has only typical specifications. Therefore, please approve our product specifications or transact the approval sheet for product specifications before ordering.

<Resin Coating>

When coating products with resin, the relatively high resin curing stress may change inductance values. For exterior coating, select resin carefully so that electrical and mechanical performance of the product is not affected. Prior to use, please evaluate reliability with the product mounted in your application set.

(LQW,LQH series)

An open circuit issue may occur by mechanical stress caused by the resin, amount/cured shape of resin, or operating conditions, etc. Some resins containing impurities or chloride may possibly generate chlorine by hydrolysis under some operating conditions, causing corrosion of the inductor wire and leading to an open circuit.

(LQP02T_02,LQP03T_02)

When products are coated with resin, please contact us in advance.

<Handling of a Substrate>

After mounting products on a substrate, do not apply any stress to the product caused by bending or twisting the substrate when cropping the substrate, inserting and removing a connector from the substrate, or tightening a screw to the substrate.

Excessive mechanical stress may cause cracking in the Product.

Bending

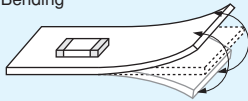

Twisting

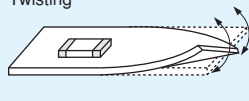

● Measuring Method

Measuring Method of Inductance/Q

1. Residual elements and stray elements of test fixtures can be described by F-parameter as shown in the following:

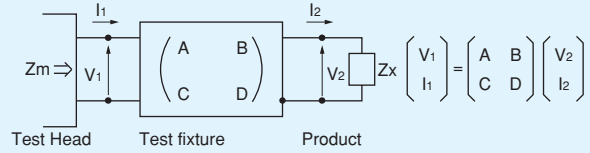

2. The impedance of chip Inductors (chip coils) Z_x and measured value Z_m can be described by input/output current/voltage.

$$Z_m = \frac{V_1}{I_1}, \quad Z_x = \frac{V_2}{I_2}$$

3. Thus, the relation between Z_x and Z_m is shown in the following:

$$Z_x = \alpha \frac{Z_m - \beta}{1 - Z_m \Gamma} \quad \text{where, } \alpha = D / A = 1$$

$$\beta = B / D = Z_{sm} - (1 - Y_{om} Z_{sm}) Z_{ss}$$

$$\Gamma = C / A = Y_{om}$$

Z_{sm} : measured impedance of short chip
 Z_{ss} : residual impedance of short chip*
 Y_{om} : measured admittance when opening the fixture)

*Residual impedance of short chip

Residual Impedance	Series
0nH	LQG15HS/LQP03TG
0.110nH	LQP02TN/LQP02TQ
0.480nH	LQP03TN_02
0.556nH	LQG15HN, LQW15A, LQP15M
0.771nH	LQG18H, LQP18M, LQW18A, LQW21H

4. L_x and Q_x should be calculated with the following equation.

$$L_x = \frac{\text{Im}(Z_x)}{2\pi f}, \quad Q_x = \frac{\text{Im}(Z_x)}{\text{Re}(Z_x)}$$

L_x : Inductance of chip Inductors (chip coils)
 Q_x : Q of chip Inductors (chip coils)
 f : Measuring frequency

⚠Note • Please read rating and ⚠CAUTION (for storage, operating, rating, soldering, mounting and handling) in this catalog to prevent smoking and/or burning, etc.
 • This catalog has only typical specifications. Therefore, please approve our product specifications or transact the approval sheet for product specifications before ordering.

1. Standard Land Pattern Dimensions

A high Q value is achieved when the PCB electrode land pattern is designed so that it does not project beyond the chip Inductors (chip coils) electrode.

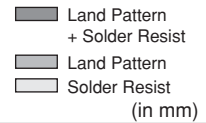

Series	Standard Land Dimensions				
LQG15H LQG18H LQP02TN LQP02TQ LQP03T LQP15M LQP18M LQW03A LQW04A LQW15A LQW18A LQW21H LQW2BH LQW2BA LQW2UA LQW31H LQH31H		Part Number	a	b	c
		LQG15H	0.4	1.4-1.5	0.5-0.6
		LQG18H	0.6-0.8	1.8-2.2	0.6-0.8
		LQP02TN	0.16-0.2	0.4-0.56	0.2-0.23
		LQP02TQ	0.2	0.56	0.2
		LQP03T	0.2-0.3	0.8-0.9	0.2-0.3
		LQP15M	0.4	1.4-1.5	0.5-0.6
		LQP18M	0.7-0.9	1.8-2.2	0.6-0.8
		LQW03A	0.23	0.65	0.4
		LQW04A	0.4	1.0	0.4
		LQW15A_00/10	0.5	1.2	0.65
		LQW15A_80	0.6	1.42	0.66
		LQW18A_00/10	0.6-0.8	1.9-2.0	0.7-1.0
		LQW18A_80	0.86	2.0	1.15
		LQW21H	1.0	2.6	1.2
		LQW2BH	0.8	3.0	1.2
		LQW2BA	0.76	2.8	1.78
LQW2UA	1.27	3.3	2.54		
LQH31H	1.0	4.5	1.5		
LQW31H					

Attention should be paid to potential magnetic coupling effects when using the Inductors (coils) as a resonator.

2. Standard Soldering Conditions

(1) Soldering method

Chip Inductors (Chip coils) can be flow or reflow soldered. Please contact Murata regarding other soldering methods.

As for LQG, LQP, LQW03A/04A/15A/18A/21H/2BA/2UA series, please use reflow soldering.

Solder: Use Sn-3.0Ag-0.5Cu solder.

Flux: Use rosin-based flux, but not strongly acidic flux (with chlorine content exceeding 0.2wt%).

Do not use water-soluble flux.

The flux used for LQW03/04/15/18/21/2BA/2UA series should use the rosin-based flux that includes middle activator equivalent to 0.06wt% to 0.1wt% chlorine.

For additional mounting methods, please contact Murata.

Continued on the following page. ↗

Note • Please read rating and CAUTION (for storage, operating, rating, soldering, mounting and handling) in this catalog to prevent smoking and/or burning, etc.
 • This catalog has only typical specifications. Therefore, please approve our product specifications or transact the approval sheet for product specifications before ordering.

(2) Soldering profile

- Flow Soldering profile (Sn-3.0Ag-0.5Cu solder)

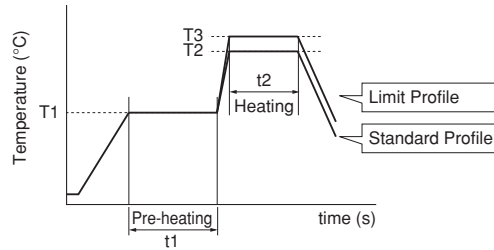

Series	Pre-heating		Standard Profile			Limit Profile		
	Temp. (T1)	Time. (t1)	Heating		Cycle of flow	Heating		Cycle of flow
			Temp. (T2)	Time. (t2)		Temp. (T3)	Time. (t2)	
LQW2BH/31H LQH31H	150°C	60s min.	250°C	4 to 6s	2 times max.	265±3°C	5s max.	2 times max.

- Reflow Soldering profile (Sn-3.0Ag-0.5Cu solder)

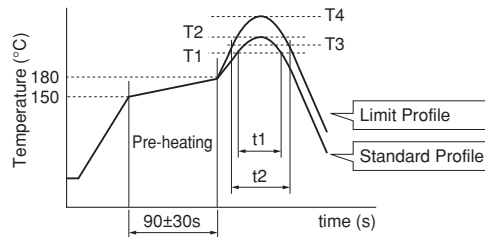

Series	Standard Profile				Limit Profile			
	Heating		Peak temperature (T2)	Cycle of reflow	Heating		Peak temperature (T4)	Cycle of reflow
	Temp. (T1)	Time. (t1)			Temp. (T3)	Time. (t2)		
LQG15H/18H LQW03A/04A/15A/18A/21H LQW2BA/2UA LQP02T/03T/15M/18M LQW2BH/31H LQH31H	220°C	30 to 60s	245±3°C	2 times max.	230°C	60s max.	260°C/10s	2 times max.

(3) Reworking with Soldering Iron

*Except for LQP02T Series

Preheating at 150°C for 1 minute is required. Do not directly touch the ceramic element with the tip of the soldering iron. The reworking soldering conditions are as follows:

Soldering iron power output: 80W max.

Temperature of soldering iron tip: 350°C

Diameter of soldering iron end: 3.0mm max.

Soldering time: within 3 s

Continued on the following page.

△Note • Please read rating and △CAUTION (for storage, operating, rating, soldering, mounting and handling) in this catalog to prevent smoking and/or burning, etc.
• This catalog has only typical specifications. Therefore, please approve our product specifications or transact the approval sheet for product specifications before ordering.

3. Mounting Instructions

(1) Land Pattern Dimensions

Large lands reduce Q of the mounted chip. Also, large protruding land areas (bordered by lines having dimensions 'c' and 'd' shown) cause floating and electrode leaching.

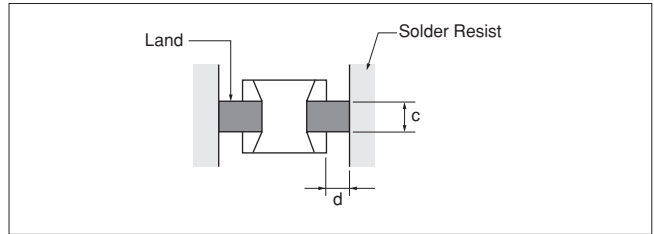

(2) Land Pattern Designing (LQW series)

Please follow the recommended patterns. Otherwise, their performance, which includes electrical performance or solderability, may be affected, or result in "position shift" in the soldering process.

(3) PCB Warping

PCB should be designed so that products are not subjected to the mechanical stress caused by warping the board.

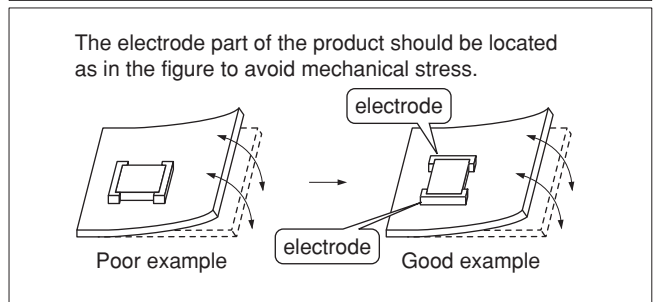
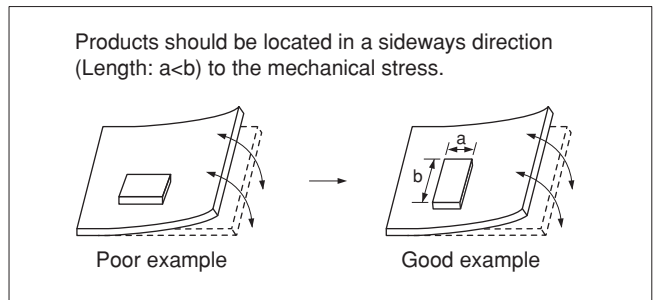

Continued on the following page. ↗

⚠Note • Please read rating and ⚠CAUTION (for storage, operating, rating, soldering, mounting and handling) in this catalog to prevent smoking and/or burning, etc.
 • This catalog has only typical specifications. Therefore, please approve our product specifications or transact the approval sheet for product specifications before ordering.

(4) Amount of Solder Paste

Excessive solder causes electrode corrosion, while insufficient solder causes low electrode bonding strength. Adjust the amount of solder paste as shown on the right so that solder is applied.

● Guideline of solder paste thickness

- LQP (Except for LQP02T), LQG, LQW15AN_00/LQW15AN_10/LQW18AN/LQW21H/LQW2BA/LQW2UA: 100 to 150µm
- LQP02T: 50 to 80µm
- LQW03A/LQW04A: 80 to 100µm
- LQW15AN_80: 50 to 100µm
- LQW_H: 200 to 300µm

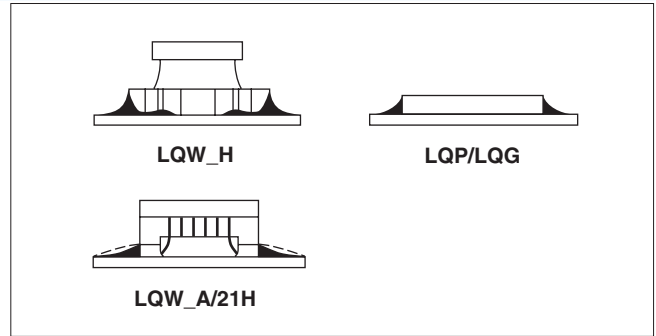

LQW15A Series:

Too much solder may cause slant or rotation of the chip at the time of solder melting. Please reduce the amount of solder by using a smaller solder area than the land pattern, as shown in the figure at right.

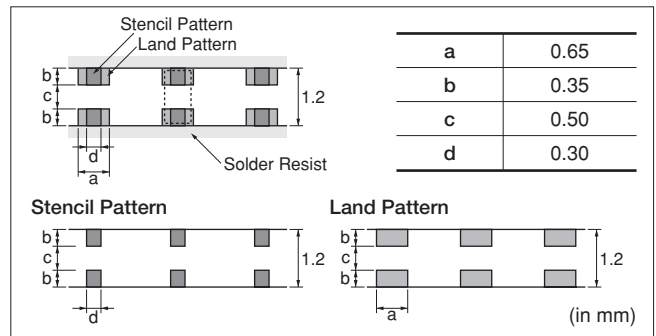

(5) Amount of Adhesive

If too much adhesive is applied, then it may overflow into the land or termination areas and yield poor solderability. In contrast, if insufficient adhesive is applied, or if the adhesive is not sufficiently hardened, then the chip may become detached during flow soldering. Apply the adhesive in accordance with the conditions shown in the chart.

Part Number	Typical Application Amount (in:mg)
	IR-100
LQW2BH	0.15-0.20
LQH31H LQW31H	0.20-0.25

4. Cleaning

The following conditions should be observed when cleaning chip inductors (chip coils):

- (1) Cleaning Temperature: 60°C max. (40°C max. for alcohol cleaning agents)
- (2) Ultrasonic
 - Output: 20W/l max.
 - Duration: 5 minutes max.
 - Frequency: 28 to 40kHz
 - Care should be taken not to cause resonance of the PCB and mounted products.

(3) Cleaning agent

The following cleaning agents have been tested on individual components. Evaluation in complete assembly should be done prior to production.

- (a) Alcohol cleaning agents
Isopropyl alcohol (IPA)
 - (b) Aqueous cleaning agents
Pine Alpha ST-100S
- (4) Ensure that flux residue is completely removed. Component should be thoroughly dried after aqueous agents have been removed with deionized water.

For additional cleaning methods, please contact Murata.

⚠Note • Please read rating and ⚠CAUTION (for storage, operating, rating, soldering, mounting and handling) in this catalog to prevent smoking and/or burning, etc.
• This catalog has only typical specifications. Therefore, please approve our product specifications or transact the approval sheet for product specifications before ordering.

■ Minimum Quantity and 8mm Width Taping Dimensions

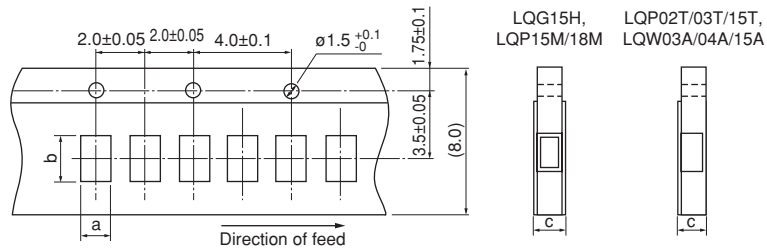

Paper Tape

Part Number	Dimensions		Total Thickness of Tape	Packaging Code (Minimum Qty. [pcs.])		
	a	b		c	ø180mm reel	ø330mm reel
LQG15H	0.62	1.12	0.8 max.	D [10000]	J [50000]	B [1000]
LQP02TN	0.24	0.47	0.39 max.	D [20000]	-	B [500]
LQP02TQ	0.24	0.45	0.39 max.	D [20000]	-	B [500]
LQP03T *1	0.35	0.65/0.67	0.55 max.	D [15000]	J [50000]	B [500]
LQP15M	0.70	1.20	0.8 max.	D [10000]	J [50000]	B [500]
LQP18M	1.19	2.0	0.8 max.	D [4000]	J [10000]	B [500]
LQW03A	0.52	0.65	0.75 max.	D [10000]	-	-
LQW04A	0.50	0.905	0.75 max.	D [10000]	-	B [500]
LQW15A_00 *2	0.64/0.66/0.69	1.18	0.8 max.	D [10000]	-	B [500]
LQW15A_10 *3	0.66/0.69	1.18	0.8 max.	D [10000]	-	B [500]
LQW15A_80	0.75	1.18	0.8 max.	D [10000]	-	B [500]

- *1 0.67 (LQP03TG · LQP03TN_02; 0.6-62nH, 130-270nH) *3 0.69 (1.3nH)
- 0.65 (LQP03TN_02; 68-120nH) 0.66 (2.2-5.6nH)
- *2 0.69 (1.5-2.7nH, 3.9-4.7nH, 5.8-6.8nH, 8.2-9.5nH, 11nH, 12nH, 15nH)
- 0.66 (2.9nH, 5.1nH, 7.3nH, 7.5nH, 10nH, 13nH, 16-23nH, 100nH, 120nH)
- 0.64 (24-91nH)

(in mm)

■ Minimum Quantity and 8mm Width Taping Dimensions

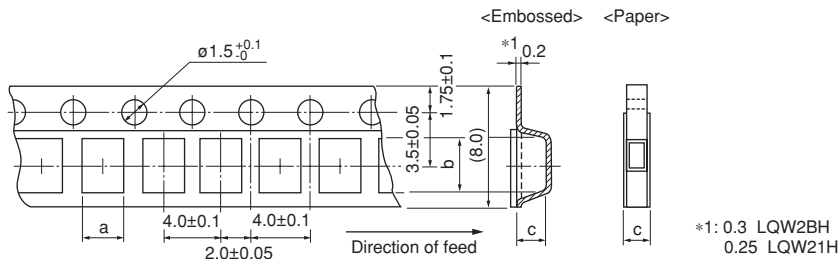

Dimension of the cavity of embossed tape is measured at the bottom side.

Paper Tape

Part Number	Dimensions		Total Thickness of Tape	Packaging Code (Minimum Qty. [pcs.])		
	a	b		c	ø180mm reel	ø330mm reel
LQG18H	1.05	1.85	1.1 max.	D [4000]	J [10000]	B [1000]
LQW18A_00	1.0	1.8	1.1 max.	D [4000]	J [10000]	B [500]
LQW18A_10	1.1	1.9	1.1 max.	D [4000]	J [10000]	B [500]
LQW18A_80	1.15	1.9	1.1 max.	D [4000]	J [10000]	B [500]

Embossed Tape

Part Number	Dimensions		Depth of Cavity	Packaging Code (Minimum Qty. [pcs.])		
	a	b		c	ø180mm reel	ø330mm reel
LQH31H, LQW31H	1.9	3.6	2.0	L [2000]	K [7500]	-
LQW21H	1.55	2.3	1.1	L [3000]	-	B [500]
LQW2BH	1.75	2.3	2.0	L [2000]	K [7500]	-
LQW2BA	1.8	2.3	1.65	L [2000]	-	-
LQW2UA	2.7	2.8	2.15	L [2000]	-	-

(in mm)

△Note • Please read rating and △CAUTION (for storage, operating, rating, soldering, mounting and handling) in this catalog to prevent smoking and/or burning, etc.
 • This catalog has only typical specifications. Therefore, please approve our product specifications or transact the approval sheet for product specifications before ordering.

RF Inductors **Design Kits**

■ Holder Type

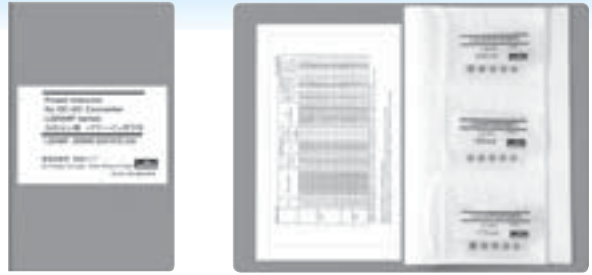

● EKLMQ15SC-KIT (RF Inductors Multilayer Type)

No.	Part Number	Quantity (pcs.)	Inductance		Q (min.)	DC Resistance (Ω) max.	Rated Current (mA)
			Nominal	Tolerance			
1	LQG15HS1N0S02	10	1.0nH	±0.3nH	8	0.07	300
2	LQG15HS1N1S02	10	1.1nH	±0.3nH	8	0.09	300
3	LQG15HS1N2S02	10	1.2nH	±0.3nH	8	0.09	300
4	LQG15HS1N3S02	10	1.3nH	±0.3nH	8	0.09	300
5	LQG15HS1N5S02	10	1.5nH	±0.3nH	8	0.10	300
6	LQG15HS1N6S02	10	1.6nH	±0.3nH	8	0.10	300
7	LQG15HS1N8S02	10	1.8nH	±0.3nH	8	0.10	300
8	LQG15HS2N0S02	10	2.0nH	±0.3nH	8	0.10	300
9	LQG15HS2N2S02	10	2.2nH	±0.3nH	8	0.12	300
10	LQG15HS2N4S02	10	2.4nH	±0.3nH	8	0.15	300
11	LQG15HS2N7S02	10	2.7nH	±0.3nH	8	0.15	300
12	LQG15HS3N0S02	10	3.0nH	±0.3nH	8	0.17	300
13	LQG15HS3N3S02	10	3.3nH	±0.3nH	8	0.17	300
14	LQG15HS3N6S02	10	3.6nH	±0.3nH	8	0.18	300
15	LQG15HS3N9S02	10	3.9nH	±0.3nH	8	0.18	300
16	LQG15HS4N3S02	10	4.3nH	±0.3nH	8	0.18	300
17	LQG15HS4N7S02	10	4.7nH	±0.3nH	8	0.18	300
18	LQG15HS5N1S02	10	5.1nH	±0.3nH	8	0.20	300
19	LQG15HS5N6S02	10	5.6nH	±0.3nH	8	0.20	300
20	LQG15HS6N2S02	10	6.2nH	±0.3nH	8	0.22	300
21	LQG15HS6N8J02	10	6.8nH	±5%	8	0.24	300
22	LQG15HS7N5J02	10	7.5nH	±5%	8	0.24	300
23	LQG15HS8N2J02	10	8.2nH	±5%	8	0.24	300
24	LQG15HS9N1J02	10	9.1nH	±5%	8	0.26	300
25	LQG15HS10NJ02	10	10nH	±5%	8	0.26	300
26	LQG15HS12NJ02	10	12nH	±5%	8	0.28	300
27	LQG15HS15NJ02	10	15nH	±5%	8	0.32	300
28	LQG15HS18NJ02	10	18nH	±5%	8	0.36	300
29	LQG15HS22NJ02	10	22nH	±5%	8	0.42	300
30	LQG15HS27NJ02	10	27nH	±5%	8	0.46	300
31	LQG15HS33NJ02	10	33nH	±5%	8	0.58	200
32	LQG15HS39NJ02	10	39nH	±5%	8	0.65	200
33	LQG15HS47NJ02	10	47nH	±5%	8	0.72	200
34	LQG15HS56NJ02	10	56nH	±5%	8	0.82	200
35	LQG15HS68NJ02	10	68nH	±5%	8	0.92	180
36	LQG15HS82NJ02	10	82nH	±5%	8	1.20	150
37	LQG15HSR10J02	10	100nH	±5%	8	1.25	150
38	LQG15HSR12J02	10	120nH	±5%	8	1.30	150
39	LQG15HSR15J02	10	150nH	±5%	8	2.99	140
40	LQG15HSR18J02	10	180nH	±5%	8	3.38	130
41	LQG15HSR22J02	10	220nH	±5%	8	3.77	120
42	LQG15HSR27J02	10	270nH	±5%	8	4.94	110

● EKLMQG18B-KIT (RF Inductors Multilayer Type)

No.	Part Number	Quantity (pcs.)	Inductance		Q (min.)	DC Resistance (Ω) max.	Rated Current (mA)
			Nominal	Tolerance			
1	LQG18HN1N2S00	10	1.2nH	±0.3nH	12	0.10	500
2	LQG18HN1N5S00	10	1.5nH	±0.3nH	12	0.10	500
3	LQG18HN1N8S00	10	1.8nH	±0.3nH	12	0.10	500
4	LQG18HN2N2S00	10	2.2nH	±0.3nH	12	0.10	500
5	LQG18HN2N7S00	10	2.7nH	±0.3nH	12	0.15	500
6	LQG18HN3N3S00	10	3.3nH	±0.3nH	12	0.15	500
7	LQG18HN3N9S00	10	3.9nH	±0.3nH	12	0.15	450
8	LQG18HN4N7S00	10	4.7nH	±0.3nH	12	0.20	450
9	LQG18HN5N6S00	10	5.6nH	±0.3nH	12	0.20	430

Continued on the following page.

△Note • Please read rating and △CAUTION (for storage, operating, rating, soldering, mounting and handling) in this catalog to prevent smoking and/or burning, etc.
 • This catalog has only typical specifications. Therefore, please approve our product specifications or transact the approval sheet for product specifications before ordering.

Continued from the preceding page.

No.	Part Number	Quantity (pcs.)	Inductance		Q (min.)	DC Resistance (Ω) max.	Rated Current (mA)
			Nominal	Tolerance			
10	LQG18HN6N8J00	10	6.8nH	±5%	12	0.25	430
11	LQG18HN8N2J00	10	8.2nH	±5%	12	0.25	400
12	LQG18HN10NJ00	10	10nH	±5%	12	0.30	400
13	LQG18HN12NJ00	10	12nH	±5%	12	0.35	400
14	LQG18HN15NJ00	10	15nH	±5%	12	0.40	350
15	LQG18HN18NJ00	10	18nH	±5%	12	0.45	350
16	LQG18HN22NJ00	10	22nH	±5%	12	0.50	300
17	LQG18HN27NJ00	10	27nH	±5%	12	0.55	300
18	LQG18HN33NJ00	10	33nH	±5%	12	0.60	300
19	LQG18HN39NJ00	10	39nH	±5%	12	0.65	300
20	LQG18HN47NJ00	10	47nH	±5%	12	0.70	300
21	LQG18HN56NJ00	10	56nH	±5%	12	0.75	300
22	LQG18HN68NJ00	10	68nH	±5%	12	0.80	300
23	LQG18HN82NJ00	10	82nH	±5%	12	0.85	300
24	LQG18HNR10J00	10	100nH	±5%	12	0.90	300

●EKLMP02F-KIT (RF Inductors Film Type)

No.	Part Number	Quantity (pcs.)	Inductance		Q (min.)	DC Resistance (Ω) max.	Rated Current (mA)
			Nominal	Tolerance			
1	LQP02TN0N2B02	10	0.2nH	±0.1nH	-	0.50	320
2	LQP02TN0N3B02	10	0.3nH	±0.1nH	-	0.50	320
3	LQP02TN0N4B02	10	0.4nH	±0.1nH	8	0.50	320
4	LQP02TN0N5B02	10	0.5nH	±0.1nH	8	0.50	320
5	LQP02TN0N6B02	10	0.6nH	±0.1nH	8	0.50	320
6	LQP02TN0N7B02	10	0.7nH	±0.1nH	8	0.50	320
7	LQP02TN0N8B02	10	0.8nH	±0.1nH	8	0.50	320
8	LQP02TN0N9B02	10	0.9nH	±0.1nH	8	0.50	320
9	LQP02TN1N0B02	10	1.0nH	±0.1nH	8	0.60	220
10	LQP02TN1N1B02	10	1.1nH	±0.1nH	8	0.60	220
11	LQP02TN1N2B02	10	1.2nH	±0.1nH	8	0.60	220
12	LQP02TN1N3B02	10	1.3nH	±0.1nH	8	0.60	220
13	LQP02TN1N4B02	10	1.4nH	±0.1nH	8	0.60	220
14	LQP02TN1N5B02	10	1.5nH	±0.1nH	8	0.60	220
15	LQP02TN1N6B02	10	1.6nH	±0.1nH	8	0.60	220
16	LQP02TN1N7B02	10	1.7nH	±0.1nH	8	0.70	200
17	LQP02TN1N8B02	10	1.8nH	±0.1nH	8	0.70	200
18	LQP02TN1N9B02	10	1.9nH	±0.1nH	8	0.75	200
19	LQP02TN2N0B02	10	2.0nH	±0.1nH	8	0.75	200
20	LQP02TN2N1B02	10	2.1nH	±0.1nH	8	0.75	200
21	LQP02TN2N2B02	10	2.2nH	±0.1nH	8	0.75	200
22	LQP02TN2N3B02	10	2.3nH	±0.1nH	8	0.75	200
23	LQP02TN2N4B02	10	2.4nH	±0.1nH	8	0.75	200
24	LQP02TN2N5B02	10	2.5nH	±0.1nH	8	0.80	200
25	LQP02TN2N6B02	10	2.6nH	±0.1nH	8	0.80	200
26	LQP02TN2N7B02	10	2.7nH	±0.1nH	8	0.80	200
27	LQP02TN2N8B02	10	2.8nH	±0.1nH	8	1.10	200
28	LQP02TN2N9B02	10	2.9nH	±0.1nH	8	1.10	200
29	LQP02TN3N0B02	10	3.0nH	±0.1nH	8	1.10	200
30	LQP02TN3N1B02	10	3.1nH	±0.1nH	8	1.30	180
31	LQP02TN3N2B02	10	3.2nH	±0.1nH	8	1.30	180
32	LQP02TN3N3B02	10	3.3nH	±0.1nH	8	1.30	180
33	LQP02TN3N4B02	10	3.4nH	±0.1nH	8	1.30	180
34	LQP02TN3N5B02	10	3.5nH	±0.1nH	8	1.30	180
35	LQP02TN3N6B02	10	3.6nH	±0.1nH	8	1.30	180
36	LQP02TN3N7B02	10	3.7nH	±0.1nH	8	1.30	180
37	LQP02TN3N8B02	10	3.8nH	±0.1nH	8	1.30	180
38	LQP02TN3N9B02	10	3.9nH	±0.1nH	8	1.30	180
39	LQP02TN4N0B02	10	4.0nH	±0.1nH	8	1.30	180
40	LQP02TN4N1B02	10	4.1nH	±0.1nH	8	1.30	180
41	LQP02TN4N2B02	10	4.2nH	±0.1nH	8	1.30	180
42	LQP02TN4N3H02	10	4.3nH	±3%	8	1.30	180
43	LQP02TN4N7H02	10	4.7nH	±3%	8	1.50	160
44	LQP02TN5N1H02	10	5.1nH	±3%	8	1.50	160
45	LQP02TN5N6H02	10	5.6nH	±3%	8	1.80	140
46	LQP02TN6N2H02	10	6.2nH	±3%	8	1.80	140

Continued on the following page.

Note • Please read rating and CAUTION (for storage, operating, rating, soldering, mounting and handling) in this catalog to prevent smoking and/or burning, etc.
 • This catalog has only typical specifications. Therefore, please approve our product specifications or transact the approval sheet for product specifications before ordering.

Continued from the preceding page.

No.	Part Number	Quantity (pcs.)	Inductance		Q (min.)	DC Resistance (Ω) max.	Rated Current (mA)
			Nominal	Tolerance			
47	LQP02TN6N8H02	10	6.8nH	±3%	8	2.00	140
48	LQP02TN7N5H02	10	7.5nH	±3%	8	2.00	140
49	LQP02TN8N2H02	10	8.2nH	±3%	8	2.10	140
50	LQP02TN9N1H02	10	9.1nH	±3%	8	2.10	140
51	LQP02TN10NH02	10	10nH	±3%	8	2.50	140
52	LQP02TN11NH02	10	11nH	±3%	7	2.80	140
53	LQP02TN12NH02	10	12nH	±3%	7	2.80	140
54	LQP02TN13NH02	10	13nH	±3%	7	3.20	140
55	LQP02TN15NH02	10	15nH	±3%	7	3.20	140
56	LQP02TN16NH02	10	16nH	±3%	7	3.50	140
57	LQP02TN18NH02	10	18nH	±3%	7	3.50	140
58	LQP02TN20NH02	10	20nH	±3%	6	5.00	100

●EKLMP3GC-KIT (RF Inductors Film Type)

No.	Part Number	Quantity (pcs.)	Inductance		Q (min.)	DC Resistance (Ω) max.	Rated Current (mA)
			Nominal	Tolerance			
1	LQP03TG0N6B02	10	0.6nH	±0.1nH	11	0.08	850
2	LQP03TG0N7B02	10	0.7nH	±0.1nH	12	0.10	750
3	LQP03TG0N8B02	10	0.8nH	±0.1nH	12	0.10	750
4	LQP03TG0N9B02	10	0.9nH	±0.1nH	12	0.12	700
5	LQP03TG1N0B02	10	1.0nH	±0.1nH	12	0.15	600
6	LQP03TG1N1B02	10	1.1nH	±0.1nH	12	0.15	600
7	LQP03TG1N2B02	10	1.2nH	±0.1nH	13	0.15	600
8	LQP03TG1N3B02	10	1.3nH	±0.1nH	13	0.15	600
9	LQP03TG1N4B02	10	1.4nH	±0.1nH	13	0.15	600
10	LQP03TG1N5B02	10	1.5nH	±0.1nH	13	0.15	600
11	LQP03TG1N6B02	10	1.6nH	±0.1nH	13	0.15	600
12	LQP03TG1N7B02	10	1.7nH	±0.1nH	13	0.20	500
13	LQP03TG1N8B02	10	1.8nH	±0.1nH	13	0.20	500
14	LQP03TG1N9B02	10	1.9nH	±0.1nH	13	0.25	450
15	LQP03TG2N0B02	10	2.0nH	±0.1nH	13	0.25	450
16	LQP03TG2N1B02	10	2.1nH	±0.1nH	13	0.25	450
17	LQP03TG2N2B02	10	2.2nH	±0.1nH	13	0.25	450
18	LQP03TG2N3B02	10	2.3nH	±0.1nH	13	0.25	450
19	LQP03TG2N4B02	10	2.4nH	±0.1nH	13	0.25	450
20	LQP03TG2N5B02	10	2.5nH	±0.1nH	13	0.25	450
21	LQP03TG2N6B02	10	2.6nH	±0.1nH	13	0.25	450
22	LQP03TG2N7B02	10	2.7nH	±0.1nH	13	0.25	450
23	LQP03TG2N8B02	10	2.8nH	±0.1nH	13	0.25	450
24	LQP03TG2N9B02	10	2.9nH	±0.1nH	13	0.25	450
25	LQP03TG3N0B02	10	3.0nH	±0.1nH	13	0.25	450
26	LQP03TG3N1B02	10	3.1nH	±0.1nH	13	0.32	400
27	LQP03TG3N2B02	10	3.2nH	±0.1nH	13	0.32	400
28	LQP03TG3N3B02	10	3.3nH	±0.1nH	13	0.32	400
29	LQP03TG3N4B02	10	3.4nH	±0.1nH	13	0.35	350
30	LQP03TG3N5B02	10	3.5nH	±0.1nH	13	0.35	350
31	LQP03TG3N6B02	10	3.6nH	±0.1nH	13	0.35	350
32	LQP03TG3N7B02	10	3.7nH	±0.1nH	13	0.35	350
33	LQP03TG3N8B02	10	3.8nH	±0.1nH	13	0.35	350
34	LQP03TG3N9B02	10	3.9nH	±0.1nH	13	0.35	350
35	LQP03TG4N3H02	10	4.3nH	±3%	13	0.58	300
36	LQP03TG4N7H02	10	4.7nH	±3%	12	0.72	250
37	LQP03TG5N1H02	10	5.1nH	±3%	12	0.72	250
38	LQP03TG5N6H02	10	5.6nH	±3%	12	0.88	250
39	LQP03TG6N2H02	10	6.2nH	±3%	12	1.15	200
40	LQP03TG6N8H02	10	6.8nH	±3%	12	1.15	200
41	LQP03TG7N5H02	10	7.5nH	±3%	12	1.22	200
42	LQP03TG8N2H02	10	8.2nH	±3%	12	1.40	200
43	LQP03TG9N1H02	10	9.1nH	±3%	11	1.40	200
44	LQP03TG10NH02	10	10nH	±3%	11	1.52	190
45	LQP03TG12NH02	10	12nH	±3%	11	1.78	180
46	LQP03TG15NH02	10	15nH	±3%	11	1.90	170
47	LQP03TG18NH02	10	18nH	±3%	11	2.28	160
48	LQP03TG22NH02	10	22nH	±3%	9	2.85	140

Continued on the following page.

⚠Note • Please read rating and ⚠CAUTION (for storage, operating, rating, soldering, mounting and handling) in this catalog to prevent smoking and/or burning, etc.
• This catalog has only typical specifications. Therefore, please approve our product specifications or transact the approval sheet for product specifications before ordering.

Continued from the preceding page.

●EKLMP3AB-KIT (RF Inductors Film Type)

No.	Part Number	Quantity (pcs.)	Inductance		Q (min.)	DC Resistance (Ω) max.	Rated Current (mA)
			Nominal	Tolerance			
1	LQP03TN0N6B02	10	0.6nH	±0.1nH	14	0.07	850
2	LQP03TN0N7B02	10	0.7nH	±0.1nH	14	0.08	800
3	LQP03TN0N8B02	10	0.8nH	±0.1nH	14	0.08	800
4	LQP03TN0N9B02	10	0.9nH	±0.1nH	14	0.10	750
5	LQP03TN1N0B02	10	1.0nH	±0.1nH	14	0.10	750
6	LQP03TN1N1B02	10	1.1nH	±0.1nH	14	0.10	750
7	LQP03TN1N2B02	10	1.2nH	±0.1nH	14	0.10	750
8	LQP03TN1N3B02	10	1.3nH	±0.1nH	14	0.15	600
9	LQP03TN1N4B02	10	1.4nH	±0.1nH	14	0.15	600
10	LQP03TN1N5B02	10	1.5nH	±0.1nH	14	0.15	600
11	LQP03TN1N6B02	10	1.6nH	±0.1nH	14	0.15	600
12	LQP03TN1N7B02	10	1.7nH	±0.1nH	14	0.15	600
13	LQP03TN1N8B02	10	1.8nH	±0.1nH	14	0.15	600
14	LQP03TN1N9B02	10	1.9nH	±0.1nH	14	0.15	600
15	LQP03TN2N0B02	10	2.0nH	±0.1nH	14	0.15	600
16	LQP03TN2N1B02	10	2.1nH	±0.1nH	14	0.15	600
17	LQP03TN2N2B02	10	2.2nH	±0.1nH	14	0.15	600
18	LQP03TN2N3B02	10	2.3nH	±0.1nH	14	0.20	500
19	LQP03TN2N4B02	10	2.4nH	±0.1nH	14	0.20	500
20	LQP03TN2N5B02	10	2.5nH	±0.1nH	14	0.20	500
21	LQP03TN2N6B02	10	2.6nH	±0.1nH	14	0.20	500
22	LQP03TN2N7B02	10	2.7nH	±0.1nH	14	0.20	500
23	LQP03TN2N8B02	10	2.8nH	±0.1nH	14	0.20	500
24	LQP03TN2N9B02	10	2.9nH	±0.1nH	14	0.20	500
25	LQP03TN3N0B02	10	3.0nH	±0.1nH	14	0.25	450
26	LQP03TN3N1B02	10	3.1nH	±0.1nH	14	0.25	450
27	LQP03TN3N2B02	10	3.2nH	±0.1nH	14	0.25	450
28	LQP03TN3N3B02	10	3.3nH	±0.1nH	14	0.25	450
29	LQP03TN3N4B02	10	3.4nH	±0.1nH	14	0.25	450
30	LQP03TN3N5B02	10	3.5nH	±0.1nH	14	0.25	450
31	LQP03TN3N6B02	10	3.6nH	±0.1nH	14	0.30	400
32	LQP03TN3N7B02	10	3.7nH	±0.1nH	14	0.30	400
33	LQP03TN3N8B02	10	3.8nH	±0.1nH	14	0.30	400
34	LQP03TN3N9B02	10	3.9nH	±0.1nH	14	0.30	400
35	LQP03TN4N0B02	10	4.0nH	±0.1nH	14	0.40	350
36	LQP03TN4N1B02	10	4.1nH	±0.1nH	14	0.40	350
37	LQP03TN4N2B02	10	4.2nH	±0.1nH	14	0.40	350
38	LQP03TN4N3H02	10	4.3nH	±3%	14	0.40	350
39	LQP03TN4N7H02	10	4.7nH	±3%	14	0.40	350
40	LQP03TN5N1H02	10	5.1nH	±3%	14	0.40	350
41	LQP03TN5N6H02	10	5.6nH	±3%	14	0.40	350
42	LQP03TN6N2H02	10	6.2nH	±3%	14	0.60	300
43	LQP03TN6N8H02	10	6.8nH	±3%	14	0.60	300
44	LQP03TN7N5H02	10	7.5nH	±3%	14	0.60	300
45	LQP03TN8N2H02	10	8.2nH	±3%	14	0.70	250
46	LQP03TN9N1H02	10	9.1nH	±3%	14	0.70	250
47	LQP03TN10NH02	10	10nH	±3%	14	0.70	250
48	LQP03TN11NH02	10	11nH	±3%	14	0.80	250
49	LQP03TN12NH02	10	12nH	±3%	12	0.70	250
50	LQP03TN13NH02	10	13nH	±3%	12	0.80	250
51	LQP03TN15NH02	10	15nH	±3%	12	0.70	250
52	LQP03TN16NH02	10	16nH	±3%	12	0.95	200
53	LQP03TN18NH02	10	18nH	±3%	12	0.80	200
54	LQP03TN20NH02	10	20nH	±3%	12	2.30	150

●EKLMP3BB-KIT (RF Inductors Film Type)

No.	Part Number	Quantity (pcs.)	Inductance		Q (min.)	DC Resistance (Ω) max.	Rated Current (mA)
			Nominal	Tolerance			
1	LQP03TN22NH02	10	22nH	±3%	12	1.90	150
2	LQP03TN24NH02	10	24nH	±3%	12	2.30	140
3	LQP03TN27NH02	10	27nH	±3%	12	2.30	140
4	LQP03TN30NH02	10	30nH	±3%	9	2.95	120
5	LQP03TN33NJ02	10	33nH	±5%	9	2.95	120

Continued on the following page.

△Note • Please read rating and △CAUTION (for storage, operating, rating, soldering, mounting and handling) in this catalog to prevent smoking and/or burning, etc.
 • This catalog has only typical specifications. Therefore, please approve our product specifications or transact the approval sheet for product specifications before ordering.

Continued from the preceding page.

No.	Part Number	Quantity (pcs.)	Inductance		Q (min.)	DC Resistance (Ω) max.	Rated Current (mA)
			Nominal	Tolerance			
6	LQP03TN36NJ02	10	36nH	±5%	9	3.00	120
7	LQP03TN39NJ02	10	39nH	±5%	9	3.00	120
8	LQP03TN43NJ02	10	43nH	±5%	9	3.60	100
9	LQP03TN47NJ02	10	47nH	±5%	9	3.60	100
10	LQP03TN51NJ02	10	51nH	±5%	9	3.90	100
11	LQP03TN56NJ02	10	56nH	±5%	9	3.90	100
12	LQP03TN62NJ02	10	62nH	±5%	8	8	100
13	LQP03TN68NJ02	10	68nH	±5%	8	8	100
14	LQP03TN75NJ02	10	75nH	±5%	8	10	100
15	LQP03TN82NJ02	10	82nH	±5%	8	10	100
16	LQP03TN91NJ02	10	91nH	±5%	8	10	80
17	LQP03TNR10J02	10	100nH	±5%	8	10	80
18	LQP03TNR11J02	10	110nH	±5%	8	12	80
19	LQP03TNR12J02	10	120nH	±5%	8	12	80
20	LQP03TNR13J02	10	130nH	±5%	5	9	80
21	LQP03TNR15J02	10	150nH	±5%	5	9	80
22	LQP03TNR16J02	10	160nH	±5%	5	11	70
23	LQP03TNR18J02	10	180nH	±5%	5	11	70
24	LQP03TNR20J02	10	200nH	±5%	5	13	60
25	LQP03TNR22J02	10	220nH	±5%	5	13	60
26	LQP03TNR24J02	10	240nH	±5%	5	15	60
27	LQP03TNR27J02	10	270nH	±5%	5	15	60

●EKLMP15B-KIT (RF Inductors Film Type)

No.	Part Number	Quantity (pcs.)	Inductance		Q (min.)	DC Resistance (Ω) max.	Rated Current (mA)
			Nominal	Tolerance			
1	LQP15MN1N0B02	10	1.0nH	±0.1nH	13	0.1	400
2	LQP15MN1N1B02	10	1.1nH	±0.1nH	13	0.1	390
3	LQP15MN1N2B02	10	1.2nH	±0.1nH	13	0.1	390
4	LQP15MN1N3B02	10	1.3nH	±0.1nH	13	0.2	280
5	LQP15MN1N5B02	10	1.5nH	±0.1nH	13	0.2	280
6	LQP15MN1N6B02	10	1.6nH	±0.1nH	13	0.3	220
7	LQP15MN1N8B02	10	1.8nH	±0.1nH	13	0.2	280
8	LQP15MN2N0B02	10	2.0nH	±0.1nH	13	0.3	220
9	LQP15MN2N2B02	10	2.2nH	±0.1nH	13	0.3	220
10	LQP15MN2N4B02	10	2.4nH	±0.1nH	13	0.3	220
11	LQP15MN2N7B02	10	2.7nH	±0.1nH	13	0.3	220
12	LQP15MN3N0B02	10	3.0nH	±0.1nH	13	0.4	190
13	LQP15MN3N3B02	10	3.3nH	±0.1nH	13	0.4	190
14	LQP15MN3N6B02	10	3.6nH	±0.1nH	13	0.5	170
15	LQP15MN3N9B02	10	3.9nH	±0.1nH	13	0.5	170
16	LQP15MN4N3B02	10	4.3nH	±0.1nH	13	0.6	160
17	LQP15MN4N7B02	10	4.7nH	±0.1nH	13	0.6	160
18	LQP15MN5N1B02	10	5.1nH	±0.1nH	13	0.7	140
19	LQP15MN5N6B02	10	5.6nH	±0.1nH	13	0.7	140
20	LQP15MN6N2B02	10	6.2nH	±0.1nH	13	0.9	130
21	LQP15MN6N8B02	10	6.8nH	±0.1nH	13	0.9	130
22	LQP15MN7N5B02	10	7.5nH	±0.1nH	13	1.1	110
23	LQP15MN8N2B02	10	8.2nH	±0.1nH	13	1.1	110
24	LQP15MN9N1B02	10	9.1nH	±0.1nH	13	1.3	100
25	LQP15MN10NG02	10	10nH	±2%	13	1.3	100
26	LQP15MN12NG02	10	12nH	±2%	13	1.6	90
27	LQP15MN15NG02	10	15nH	±2%	13	1.8	90
28	LQP15MN18NG02	10	18nH	±2%	13	2.0	80
29	LQP15MN22NG02	10	22nH	±2%	13	2.6	70
30	LQP15MN27NG02	10	27nH	±2%	13	3.1	70
31	LQP15MN33NG02	10	33nH	±2%	13	3.8	60

●EKLQW03A-KIT (RF Inductors Wire Wound Type)

No.	Part Number	Quantity (pcs.)	Inductance		DC Resistance (Ω) max.	Rated Current (mA)
			Nominal	Tolerance		
1	LQW03AW5N4J00	10	5.4nH	±5%	0.21	420
2	LQW03AW5N6J00	10	5.6nH	±5%	0.33	330
3	LQW03AW5N8J00	10	5.8nH	±5%	0.16	460
4	LQW03AW6N8J00	10	6.8nH	±5%	0.18	460

Continued on the following page. ↗

⚠Note • Please read rating and ⚠CAUTION (for storage, operating, rating, soldering, mounting and handling) in this catalog to prevent smoking and/or burning, etc.
• This catalog has only typical specifications. Therefore, please approve our product specifications or transact the approval sheet for product specifications before ordering.

Continued from the preceding page.

No.	Part Number	Quantity (pcs.)	Inductance		DC Resistance (Ω) max.	Rated Current (mA)
			Nominal	Tolerance		
5	LQW03AW7N5J00	10	7.5nH	$\pm 5\%$	0.24	400
6	LQW03AW8N7J00	10	8.7nH	$\pm 5\%$	0.42	290
7	LQW03AW9N1J00	10	9.1nH	$\pm 5\%$	0.22	460
8	LQW03AW13NJ00	10	13nH	$\pm 5\%$	0.54	280



●EKLQW04D-KIT (RF Inductors Wire Wound Type)

No.	Part Number	Quantity (pcs.)	Inductance		Q (min.)	DC Resistance (Ω) max.	Rated Current (mA)
			Nominal	Tolerance			
1	LQW04AN1N1C00	10	1.1nH	$\pm 0.2nH$	15	0.03	990
2	LQW04AN1N8C00	10	1.8nH	$\pm 0.2nH$	15	0.06	700
3	LQW04AN2N7C00	10	2.7nH	$\pm 0.2nH$	15	0.07	570
4	LQW04AN3N0C00	10	3.0nH	$\pm 0.2nH$	15	0.07	620
5	LQW04AN3N3C00	10	3.3nH	$\pm 0.2nH$	10	0.14	440
6	LQW04AN3N6C00	10	3.6nH	$\pm 0.2nH$	15	0.10	530
7	LQW04AN3N9C00	10	3.9nH	$\pm 0.2nH$	15	0.10	530
8	LQW04AN4N3C00	10	4.3nH	$\pm 0.2nH$	15	0.10	530
9	LQW04AN4N7C00	10	4.7nH	$\pm 0.2nH$	20	0.14	440
10	LQW04AN5N1C00	10	5.1nH	$\pm 0.2nH$	20	0.12	470
11	LQW04AN5N6C00	10	5.6nH	$\pm 0.2nH$	20	0.12	470
12	LQW04AN6N2C00	10	6.2nH	$\pm 0.2nH$	20	0.19	390
13	LQW04AN6N8C00	10	6.8nH	$\pm 0.2nH$	20	0.14	440
14	LQW04AN7N5C00	10	7.5nH	$\pm 0.2nH$	20	0.14	440
15	LQW04AN8N2C00	10	8.2nH	$\pm 0.2nH$	20	0.23	350
16	LQW04AN9N1C00	10	9.1nH	$\pm 0.2nH$	20	0.16	400
17	LQW04AN10NH00	10	10nH	$\pm 3\%$	20	0.26	330
18	LQW04AN11NH00	10	11nH	$\pm 3\%$	15	0.28	310
19	LQW04AN12NH00	10	12nH	$\pm 3\%$	15	0.28	310
20	LQW04AN13NH00	10	13nH	$\pm 3\%$	15	0.34	280
21	LQW04AN15NH00	10	15nH	$\pm 3\%$	15	0.48	240
22	LQW04AN16NH00	10	16nH	$\pm 3\%$	15	0.38	270
23	LQW04AN18NH00	10	18nH	$\pm 3\%$	15	0.54	220
24	LQW04AN19NH00	10	19nH	$\pm 3\%$	15	0.73	160
25	LQW04AN20NH00	10	20nH	$\pm 3\%$	15	0.56	210
26	LQW04AN22NH00	10	22nH	$\pm 3\%$	15	0.63	200
27	LQW04AN23NH00	10	23nH	$\pm 3\%$	15	0.95	160
28	LQW04AN24NH00	10	24nH	$\pm 3\%$	15	0.95	160
29	LQW04AN25NH00	10	25nH	$\pm 3\%$	15	0.95	160
30	LQW04AN27NH00	10	27nH	$\pm 3\%$	15	0.95	160
31	LQW04AN33NH00	10	33nH	$\pm 3\%$	15	1.11	140

●EKLQW15K-KIT (RF Inductors Wire Wound Type)

No.	Part Number	Quantity (pcs.)	Inductance		Q (min.)	DC Resistance (Ω) max.	Rated Current (mA)
			Nominal	Tolerance			
1	LQW15AN1N5B00	10	1.5nH	$\pm 0.1nH$	10	0.03	1000
2	LQW15AN2N4B00	10	2.4nH	$\pm 0.1nH$	20	0.05	850
3	LQW15AN2N5B00	10	2.5nH	$\pm 0.1nH$	20	0.05	850
4	LQW15AN2N7B00	10	2.7nH	$\pm 0.1nH$	20	0.05	850
5	LQW15AN2N9B00	10	2.9nH	$\pm 0.1nH$	20	0.07	750
6	LQW15AN3N9B00	10	3.9nH	$\pm 0.1nH$	25	0.07	750
7	LQW15AN4N1B00	10	4.1nH	$\pm 0.1nH$	25	0.07	750
8	LQW15AN4N3B00	10	4.3nH	$\pm 0.1nH$	25	0.07	750
9	LQW15AN4N7B00	10	4.7nH	$\pm 0.1nH$	25	0.07	750
10	LQW15AN5N1B00	10	5.1nH	$\pm 0.1nH$	25	0.12	600
11	LQW15AN5N8B00	10	5.8nH	$\pm 0.1nH$	25	0.12	700
12	LQW15AN6N2B00	10	6.2nH	$\pm 0.1nH$	25	0.09	700
13	LQW15AN6N8G00	10	6.8nH	$\pm 2\%$	25	0.09	700
14	LQW15AN7N3G00	10	7.3nH	$\pm 2\%$	25	0.13	570
15	LQW15AN7N5G00	10	7.5nH	$\pm 2\%$	25	0.13	570
16	LQW15AN8N2G00	10	8.2nH	$\pm 2\%$	25	0.14	540
17	LQW15AN8N7G00	10	8.7nH	$\pm 2\%$	25	0.14	540
18	LQW15AN9N1G00	10	9.1nH	$\pm 2\%$	25	0.14	540
19	LQW15AN9N5G00	10	9.5nH	$\pm 2\%$	25	0.14	540
20	LQW15AN10NG00	10	10nH	$\pm 2\%$	25	0.17	500
21	LQW15AN11NG00	10	11nH	$\pm 2\%$	30	0.14	500
22	LQW15AN12NG00	10	12nH	$\pm 2\%$	30	0.14	500

Continued on the following page. 

 Note • Please read rating and  CAUTION (for storage, operating, rating, soldering, mounting and handling) in this catalog to prevent smoking and/or burning, etc.
• This catalog has only typical specifications. Therefore, please approve our product specifications or transact the approval sheet for product specifications before ordering.

Continued from the preceding page.

No.	Part Number	Quantity (pcs.)	Inductance		Q (min.)	DC Resistance (Ω) max.	Rated Current (mA)
			Nominal	Tolerance			
23	LQW15AN13NG00	10	13nH	±2%	25	0.21	430
24	LQW15AN15NG00	10	15nH	±2%	30	0.16	460
25	LQW15AN16NG00	10	16nH	±2%	25	0.24	370
26	LQW15AN18NG00	10	18nH	±2%	25	0.27	370
27	LQW15AN19NG00	10	19nH	±2%	25	0.27	370
28	LQW15AN20NG00	10	20nH	±2%	25	0.27	370
29	LQW15AN22NG00	10	22nH	±2%	25	0.30	310
30	LQW15AN23NG00	10	23nH	±2%	25	0.30	310
31	LQW15AN24NG00	10	24nH	±2%	25	0.52	280
32	LQW15AN27NG00	10	27nH	±2%	25	0.52	280
33	LQW15AN30NG00	10	30nH	±2%	25	0.58	270
34	LQW15AN33NG00	10	33nH	±2%	25	0.63	260
35	LQW15AN36NG00	10	36nH	±2%	25	0.63	260
36	LQW15AN39NG00	10	39nH	±2%	25	0.70	250
37	LQW15AN40NG00	10	40nH	±2%	25	0.70	250
38	LQW15AN43NG00	10	43nH	±2%	25	0.70	250
39	LQW15AN47NG00	10	47nH	±2%	25	1.08	210
40	LQW15AN51NG00	10	51nH	±2%	25	1.08	210
41	LQW15AN56NG00	10	56nH	±2%	25	1.17	200
42	LQW15AN62NG00	10	62nH	±2%	20	1.82	145
43	LQW15AN68NG00	10	68nH	±2%	20	1.96	140
44	LQW15AN72NG00	10	72nH	±2%	20	2.10	135
45	LQW15AN75NG00	10	75nH	±2%	20	2.10	135
46	LQW15AN82NG00	10	82nH	±2%	20	2.24	130
47	LQW15AN91NG00	10	91nH	±2%	20	2.38	125
48	LQW15ANR10J00	10	100nH	±5%	20	2.52	120
49	LQW15ANR12J00	10	120nH	±5%	20	2.66	110
50	LQW15AN1N3C10	10	1.3nH	±0.2nH	20	0.017	1200
51	LQW15AN2N2C10	10	2.2nH	±0.2nH	25	0.027	1000
52	LQW15AN2N4D10	10	2.4nH	±0.5nH	25	0.027	1000
53	LQW15AN3N3D10	10	3.3nH	±0.5nH	30	0.04	900
54	LQW15AN3N4C10	10	3.4nH	±0.2nH	30	0.04	900
55	LQW15AN3N6C10	10	3.6nH	±0.2nH	30	0.04	900
56	LQW15AN3N9D10	10	3.9nH	±0.5nH	30	0.040	900
57	LQW15AN4N7D10	10	4.7nH	±0.5nH	30	0.051	800
58	LQW15AN5N1C10	10	5.1nH	±0.2nH	30	0.051	800
59	LQW15AN5N6C10	10	5.6nH	±0.2nH	30	0.051	800

●EKLQW80A-KIT (RF Inductors Wire Wound Type)

No.	Part Number	Quantity (pcs.)	Inductance		Q (min.)	DC Resistance (Ω) max.	Rated Current (mA)
			Nominal	Tolerance			
1	LQW15AN1N3C80	10	1.3nH	±0.2nH	20	0.012	3150
2	LQW15AN2N3B80	10	2.3nH	±0.1nH	30	0.022	2530
3	LQW15AN2N4B80	10	2.4nH	±0.1nH	30	0.022	2530
4	LQW15AN3N4B80	10	3.4nH	±0.1nH	30	0.030	1950
5	LQW15AN3N6B80	10	3.6nH	±0.1nH	30	0.030	1950
6	LQW15AN3N8B80	10	3.8nH	±0.1nH	35	0.030	1950
7	LQW15AN3N9B80	10	3.9nH	±0.1nH	35	0.030	1950
8	LQW15AN4N0B80	10	4.0nH	±0.1nH	30	0.030	1950
9	LQW15AN5N1B80	10	5.1nH	±0.1nH	35	0.040	1770
10	LQW15AN5N2B80	10	5.2nH	±0.1nH	35	0.040	1770
11	LQW15AN5N4B80	10	5.4nH	±0.1nH	35	0.040	1770
12	LQW15AN5N6B80	10	5.6nH	±0.1nH	35	0.040	1770
13	LQW15AN5N7B80	10	5.7nH	±0.1nH	30	0.040	1770
14	LQW15AN5N8B80	10	5.8nH	±0.1nH	30	0.040	1770
15	LQW15AN7N4G80	10	7.4nH	±2%	30	0.050	1700
16	LQW15AN7N5G80	10	7.5nH	±2%	35	0.050	1700
17	LQW15AN7N6G80	10	7.6nH	±2%	30	0.050	1700
18	LQW15AN7N7G80	10	7.7nH	±2%	30	0.050	1700
19	LQW15AN7N8G80	10	7.8nH	±2%	30	0.050	1700
20	LQW15AN8N0G80	10	8.0nH	±2%	30	0.050	1700
21	LQW15AN13NG80	10	13nH	±2%	30	0.093	1240
22	LQW15AN27NG80	10	27nH	±2%	30	0.288	680
23	LQW15AN33NG80	10	33nH	±2%	30	0.336	620
24	LQW15AN43NG80	10	43nH	±2%	30	0.516	515

Continued on the following page.

Note • Please read rating and CAUTION (for storage, operating, rating, soldering, mounting and handling) in this catalog to prevent smoking and/or burning, etc.
 • This catalog has only typical specifications. Therefore, please approve our product specifications or transact the approval sheet for product specifications before ordering.

Continued from the preceding page.

No.	Part Number	Quantity (pcs.)	Inductance		Q (min.)	DC Resistance (Ω) max.	Rated Current (mA)
			Nominal	Tolerance			
25	LQW15AN53NG80	10	53nH	±2%	25	0.696	415
26	LQW15AN75NG80	10	75nH	±2%	25	1.224	320

●EKLQW18A-KIT (RF Inductors Wire Wound Type)

No.	Part Number	Quantity (pcs.)	Inductance		Q (min.)	DC Resistance (Ω) max.	Rated Current (mA)
			Nominal	Tolerance			
1	LQW18AN3N6C00	10	3.6nH	±0.2nH	25	0.059	850
2	LQW18AN3N9C00	10	3.9nH	±0.2nH	35	0.059	850
3	LQW18AN4N3C00	10	4.3nH	±0.2nH	35	0.059	850
4	LQW18AN5N6C00	10	5.6nH	±0.2nH	35	0.082	750
5	LQW18AN6N2C00	10	6.2nH	±0.2nH	35	0.082	750
6	LQW18AN6N8C00	10	6.8nH	±0.2nH	35	0.082	750
7	LQW18AN10NG00	10	10nH	±2%	35	0.11	650
8	LQW18AN11NG00	10	11nH	±2%	35	0.11	650
9	LQW18AN12NG00	10	12nH	±2%	35	0.13	600
10	LQW18AN13NG00	10	13nH	±2%	35	0.13	600
11	LQW18AN15NG00	10	15nH	±2%	40	0.13	600
12	LQW18AN16NG00	10	16nH	±2%	40	0.16	550
13	LQW18AN18NG00	10	18nH	±2%	40	0.16	550
14	LQW18AN20NG00	10	20nH	±2%	40	0.16	550
15	LQW18AN22NG00	10	22nH	±2%	40	0.17	500
16	LQW18AN24NG00	10	24nH	±2%	40	0.21	500
17	LQW18AN27NG00	10	27nH	±2%	40	0.21	440
18	LQW18AN30NG00	10	30nH	±2%	40	0.23	420
19	LQW18AN33NG00	10	33nH	±2%	40	0.23	420
20	LQW18AN36NG00	10	36nH	±2%	40	0.26	400
21	LQW18AN39NG00	10	39nH	±2%	40	0.26	400
22	LQW18AN43NG00	10	43nH	±2%	40	0.29	380
23	LQW18AN47NG00	10	47nH	±2%	38	0.29	380
24	LQW18AN51NG00	10	51nH	±2%	38	0.33	370
25	LQW18AN56NG00	10	56nH	±2%	38	0.35	360
26	LQW18AN62NG00	10	62nH	±2%	38	0.51	280
27	LQW18AN68NG00	10	68nH	±2%	38	0.38	340
28	LQW18AN72NG00	10	72nH	±2%	34	0.56	270
29	LQW18AN75NG00	10	75nH	±2%	34	0.56	270
30	LQW18AN82NG00	10	82nH	±2%	34	0.60	250
31	LQW18AN91NG00	10	91nH	±2%	34	0.64	230
32	LQW18ANR10G00	10	100nH	±2%	34	0.68	220
33	LQW18ANR11G00	10	110nH	±2%	32	1.2	200
34	LQW18ANR12G00	10	120nH	±2%	32	1.3	180
35	LQW18ANR13G00	10	130nH	±2%	32	1.4	170
36	LQW18ANR15G00	10	150nH	±2%	32	1.5	160
37	LQW18ANR16G00	10	160nH	±2%	32	2.1	150
38	LQW18ANR18G00	10	180nH	±2%	25	2.2	140
39	LQW18ANR20G00	10	200nH	±2%	25	2.4	120
40	LQW18ANR22G00	10	220nH	±2%	25	2.5	120
41	LQW18ANR27G00	10	270nH	±2%	30	3.4	110
42	LQW18ANR33G00	10	330nH	±2%	30	5.5	85
43	LQW18ANR39G00	10	390nH	±2%	30	6.2	80
44	LQW18ANR47G00	10	470nH	±2%	30	7.0	75
45	LQW18AN3N9C10	10	3.9nH	±0.2nH	38	0.032	1000
46	LQW18AN6N8C10	10	6.8nH	±0.2nH	38	0.045	900
47	LQW18AN10NG10	10	10nH	±2%	38	0.058	800
48	LQW18AN12NG10	10	12nH	±2%	38	0.071	750
49	LQW18AN18NG10	10	18nH	±2%	42	0.085	700
50	LQW18AN22NG10	10	22nH	±2%	42	0.099	640
51	LQW18AN27NG10	10	27nH	±2%	42	0.116	590

●EKLQ80GB-KIT (RF Inductors Wire Wound Type)

No.	Part Number	Quantity (pcs.)	Inductance		Q (min.)	DC Resistance (Ω) max.	Rated Current (mA)
			Nominal	Tolerance			
1	LQW18AN4N3B80	10	4.3nH	±0.1nH	35	0.036	2100
2	LQW18AN4N7B80	10	4.7nH	±0.1nH	25	0.054	1500
3	LQW18AN4N9B80	10	4.9nH	±0.1nH	23	0.081	1200
4	LQW18AN30NG80	10	30nH	±2%	40	0.12	1100

Continued on the following page.

Note • Please read rating and CAUTION (for storage, operating, rating, soldering, mounting and handling) in this catalog to prevent smoking and/or burning, etc.
 • This catalog has only typical specifications. Therefore, please approve our product specifications or transact the approval sheet for product specifications before ordering.

Continued from the preceding page.

No.	Part Number	Quantity (pcs.)	Inductance		Q (min.)	DC Resistance (Ω) max.	Rated Current (mA)
			Nominal	Tolerance			
5	LQW18AN36NG80	10	36nH	±2%	37	0.2	910
6	LQW18AN39NG80	10	39nH	±2%	40	0.16	1000
7	LQW18AN43NG80	10	43nH	±2%	40	0.21	840
8	LQW18AN47NG80	10	47nH	±2%	32	0.23	830
9	LQW18AN51NG80	10	51nH	±2%	32	0.23	830
10	LQW18AN56NG80	10	56nH	±2%	38	0.26	770
11	LQW18AN68NG80	10	68nH	±2%	37	0.38	630
12	LQW18AN72NG80	10	72nH	±2%	34	0.47	560
13	LQW18AN75NG80	10	75nH	±2%	28	0.41	590
14	LQW18AN82NG80	10	82nH	±2%	34	0.5	550
15	LQW18AN91NG80	10	91nH	±2%	33	0.54	520
16	LQW18ANR10G80	10	100nH	±2%	34	0.63	490
17	LQW18ANR11G80	10	110nH	±2%	32	0.7	450
18	LQW18ANR12G80	10	120nH	±2%	32	0.72	450
19	LQW18ANR15G80	10	150nH	±2%	28	0.87	420
20	LQW18ANR18G80	10	180nH	±2%	25	1.65	310
21	LQW18ANR20G80	10	200nH	±2%	25	1.74	290
22	LQW18ANR21G80	10	210nH	±2%	27	1.98	280
23	LQW18ANR22G80	10	220nH	±2%	25	2.08	280
24	LQW18ANR25G80	10	250nH	±2%	24	2.28	250
25	LQW18ANR27G80	10	270nH	±2%	24	2.42	260
26	LQW18ANR30G80	10	300nH	±2%	25	3.12	220
27	LQW18ANR33G80	10	330nH	±2%	25	3.84	190
28	LQW18ANR36G80	10	360nH	±2%	25	3.98	190
29	LQW18ANR39G80	10	390nH	±2%	25	4.23	190

●EKLQW21A-KIT (RF Inductors Wire Wound Ferrite Core Type)

No.	Part Number	Quantity (pcs.)	Inductance		Q (min.)	DC Resistance (Ω) max.	Rated Current (mA)
			Nominal	Tolerance			
1	LQW21HNR47J00	10	0.47μH	±5%	35	1.30	160
2	LQW21HNR56J00	10	0.56μH	±5%	35	1.43	150
3	LQW21HNR68J00	10	0.68μH	±5%	35	2.21	130
4	LQW21HNR82J00	10	0.82μH	±5%	35	2.34	125
5	LQW21HN1R0J00	10	1.0μH	±5%	35	2.86	115
6	LQW21HN1R2J00	10	1.2μH	±5%	35	3.12	100
7	LQW21HN1R5J00	10	1.5μH	±5%	35	5.33	85
8	LQW21HN1R8J00	10	1.8μH	±5%	35	5.85	80
9	LQW21HN2R2J00	10	2.2μH	±5%	35	6.50	75

●EKLQW2BC-KIT (RF Inductors Wire Wound Air Core Type)

No.	Part Number	Quantity (pcs.)	Inductance		Q (min.)	DC Resistance (Ω) max.	Rated Current (mA)
			Nominal	Tolerance			
1	LQW2BHN2N7D13	10	2.7nH	±0.5nH	20	0.02	1900
2	LQW2BHN3N1D13	10	3.1nH	±0.5nH	20	0.02	1800
3	LQW2BHN3N3D13	10	3.3nH	±0.5nH	20	0.02	1700
4	LQW2BHN5N6D13	10	5.6nH	±0.5nH	35	0.02	1500
5	LQW2BHN6N8D13	10	6.8nH	±0.5nH	35	0.02	1400
6	LQW2BHN8N6D13	10	8.6nH	±0.5nH	35	0.03	1300
7	LQW2BHN10NJ13	10	10nH	±5%	35	0.03	1320
8	LQW2BHN12NK13	10	12nH	±10%	40	0.04	1100
9	LQW2BHN15NK13	10	15nH	±10%	40	0.04	1000
10	LQW2BHN18NK13	10	18.8nH	±10%	40	0.05	1000
11	LQW2BHN21NK13	10	21nH	±10%	40	0.05	950
12	LQW2BHN27NK13	10	27nH	±10%	40	0.06	900
13	LQW2BHN33NG03	10	33nH	±2%	40	0.15	570
14	LQW2BHN39NG03	10	39nH	±2%	40	0.09	730
15	LQW2BHN47NG03	10	47nH	±2%	40	0.23	450
16	LQW2BHN56NG03	10	56nH	±2%	40	0.26	430
17	LQW2BHN68NG03	10	68nH	±2%	40	0.23	460
18	LQW2BHN82NG03	10	82nH	±2%	40	0.42	320
19	LQW2BHNR10G03	10	100nH	±2%	35	0.55	270
20	LQW2BHNR12G03	10	120nH	±2%	40	0.40	320
21	LQW2BHNR15G03	10	150nH	±2%	30	0.68	260
22	LQW2BHNR18G03	10	180nH	±2%	35	0.71	250
23	LQW2BHNR22G03	10	220nH	±2%	35	0.70	240

Continued on the following page. ↗

⚠Note • Please read rating and ⚠CAUTION (for storage, operating, rating, soldering, mounting and handling) in this catalog to prevent smoking and/or burning, etc.
• This catalog has only typical specifications. Therefore, please approve our product specifications or transact the approval sheet for product specifications before ordering.

Continued from the preceding page.

No.	Part Number	Quantity (pcs.)	Inductance		Q (min.)	DC Resistance (Ω) max.	Rated Current (mA)
			Nominal	Tolerance			
24	LQW2BHNR27K03	10	270nH	±10%	15	2.00	190
25	LQW2BHNR33K03	10	330nH	±10%	15	2.20	180
26	LQW2BHNR39K03	10	390nH	±10%	15	2.50	170
27	LQW2BHNR47K03	10	470nH	±10%	15	2.80	160

● EKLW2BUB-KIT (RF Inductors Wire Wound Type)

No.	Part Number	Quantity (pcs.)	Inductance		Q (min.)	DC Resistance (Ω) max.	Rated Current (mA)
			Nominal	Tolerance			
1	LQW2BAS2N8J00	10	2.8nH	±5%	80	0.06	800
2	LQW2BAS3N0J00	10	3nH	±5%	65	0.06	800
3	LQW2BAS5N6J00	10	5.6nH	±5%	65	0.08	600
4	LQW2BAS6N8J00	10	6.8nH	±5%	50	0.11	600
5	LQW2BAS7N5J00	10	7.5nH	±5%	50	0.14	600
6	LQW2BAS8N2J00	10	8.2nH	±5%	50	0.12	600
7	LQW2BAS10NJ00	10	10nH	±5%	60	0.10	600
8	LQW2BAS12NJ00	10	12nH	±5%	50	0.15	600
9	LQW2BAS15NJ00	10	15nH	±5%	50	0.17	600
10	LQW2BAS18NJ00	10	18nH	±5%	50	0.20	600
11	LQW2BAS22NJ00	10	22nH	±5%	55	0.22	500
12	LQW2BAS24NJ00	10	24nH	±5%	50	0.22	500
13	LQW2BAS27NJ00	10	27nH	±5%	55	0.25	500
14	LQW2BAS33NG00	10	33nH	±2%	60	0.27	500
15	LQW2BAS36NG00	10	36nH	±2%	55	0.27	500
16	LQW2BAS39NG00	10	39nH	±2%	60	0.29	500
17	LQW2BAS43NG00	10	43nH	±2%	60	0.34	500
18	LQW2BAS47NG00	10	47nH	±2%	60	0.31	500
19	LQW2BAS56NG00	10	56nH	±2%	60	0.34	500
20	LQW2BAS68NG00	10	68nH	±2%	60	0.38	500
21	LQW2BAS82NG00	10	82nH	±2%	65	0.42	400
22	LQW2BAS91NG00	10	91nH	±2%	65	0.48	400
23	LQW2BASR10G00	10	100nH	±2%	65	0.46	400
24	LQW2BASR11G00	10	110nH	±2%	50	0.48	400
25	LQW2BASR12G00	10	120nH	±2%	50	0.51	400
26	LQW2BASR15G00	10	150nH	±2%	50	0.56	400
27	LQW2BASR18G00	10	180nH	±2%	50	0.64	400
28	LQW2BASR22G00	10	220nH	±2%	50	0.70	400
29	LQW2BASR24G00	10	240nH	±2%	44	1.00	350
30	LQW2BASR27G00	10	270nH	±2%	48	1.00	350
31	LQW2BASR33G00	10	330nH	±2%	48	1.40	310
32	LQW2BASR39J00	10	390nH	±5%	48	1.50	290
33	LQW2BASR47J00	10	470nH	±5%	33	1.76	250
34	LQW2BASR56J00	10	560nH	±5%	23	1.90	230
35	LQW2BASR68J00	10	680nH	±5%	23	2.20	190
36	LQW2BASR82J00	10	820nH	±5%	23	2.35	180
37	LQW2UAS12NG00	10	12nH	±2%	50	0.09	1000
38	LQW2UAS18NG00	10	18nH	±2%	50	0.11	1000
39	LQW2UAS22NG00	10	22nH	±2%	55	0.12	1000
40	LQW2UAS27NG00	10	27nH	±2%	55	0.13	1000
41	LQW2UAS33NG00	10	33nH	±2%	60	0.14	1000
42	LQW2UAS39NG00	10	39nH	±2%	60	0.15	1000
43	LQW2UAS47NG00	10	47nH	±2%	65	0.16	1000
44	LQW2UAS56NG00	10	56nH	±2%	65	0.18	1000
45	LQW2UAS68NG00	10	68nH	±2%	65	0.2	1000
46	LQW2UAS82NG00	10	82nH	±2%	60	0.22	1000
47	LQW2UASR10G00	10	100nH	±2%	60	0.56	650
48	LQW2UASR12G00	10	120nH	±2%	60	0.63	650
49	LQW2UASR15G00	10	150nH	±2%	45	0.7	580
50	LQW2UASR18G00	10	180nH	±2%	45	0.77	620
51	LQW2UASR22G00	10	220nH	±2%	45	0.84	500
52	LQW2UASR27G00	10	270nH	±2%	45	0.91	500
53	LQW2UASR33G00	10	330nH	±2%	45	1.05	450
54	LQW2UASR39G00	10	390nH	±2%	45	1.12	470
55	LQW2UASR47G00	10	470nH	±2%	45	1.19	470
56	LQW2UASR56G00	10	560nH	±2%	45	1.33	400
57	LQW2UASR62G00	10	620nH	±2%	45	1.4	300

Continued on the following page.

⚠Note • Please read rating and ⚠CAUTION (for storage, operating, rating, soldering, mounting and handling) in this catalog to prevent smoking and/or burning, etc.
 • This catalog has only typical specifications. Therefore, please approve our product specifications or transact the approval sheet for product specifications before ordering.

Continued from the preceding page.

No.	Part Number	Quantity (pcs.)	Inductance		Q (min.)	DC Resistance (Ω) max.	Rated Current (mA)
			Nominal	Tolerance			
58	LQW2UASR68G00	10	680nH	$\pm 2\%$	45	1.47	400
59	LQW2UASR75G00	10	750nH	$\pm 2\%$	45	1.54	360
60	LQW2UASR82G00	10	820nH	$\pm 2\%$	45	1.61	400
61	LQW2UASR91G00	10	910nH	$\pm 2\%$	35	1.68	380
62	LQW2UAS1R0G00	10	1000nH	$\pm 2\%$	35	1.75	370
63	LQW2UAS1R2J00	10	1200nH	$\pm 5\%$	35	2.0	310
64	LQW2UAS1R5J00	10	1500nH	$\pm 5\%$	28	2.3	330
65	LQW2UAS1R8J00	10	1800nH	$\pm 5\%$	28	2.6	300
66	LQW2UAS2R2J00	10	2200nH	$\pm 5\%$	28	2.8	280
67	LQW2UAS2R7J00	10	2700nH	$\pm 5\%$	22	3.2	290
68	LQW2UAS3R3J00	10	3300nH	$\pm 5\%$	22	3.4	290
69	LQW2UAS3R9J00	10	3900nH	$\pm 5\%$	20	3.6	260
70	LQW2UAS4R7J00	10	4700nH	$\pm 5\%$	20	4.0	260

Δ Note • Please read rating and Δ CAUTION (for storage, operating, rating, soldering, mounting and handling) in this catalog to prevent smoking and/or burning, etc.
 • This catalog has only typical specifications. Therefore, please approve our product specifications or transact the approval sheet for product specifications before ordering.



Inductors for Power Lines

LQH2HPN	p.46
LQH2MCN	p.42
LQH31CN	p.90
LQH32CN	p.91
LQH32PB	p.65
LQH32PN	p.61
LQH3NPN	p.59
LQH43CN	p.94
LQH43PB	p.71
LQH43PN	p.69
LQH44PN	p.75
LQH55DN	p.96
LQH5BPB	p.79
LQH5BPN	p.77
LQH66SN	p.98
LQM18FN	p.81
LQM18PN	p.16
LQM21DN	p.82
LQM21FN	p.83
LQM21PN	p.22
LQM2HPN	p.38
LQM2MPN	p.27
LQM31PN	p.39
LQM32PN	p.41
LQW15CN	p.86
LQW18CN	p.89

Inductors for General Use

LQB15NN	p.119
LQB18NN	p.121
LQH31MN	p.127
LQH32MN	p.129
LQH43MN	p.131
LQH43NN	p.131
LQH44NN	p.134
LQM18NN	p.123
LQM21NN	p.125

RF Inductors

LQG15HN	p.148
LQG15HS	p.150
LQG18HN	p.153
LQH31HN	p.223
LQP02TN	p.155
LQP02TQ	p.161
LQP03TG	p.164
LQP03TN	p.169
LQP15MN	p.174
LQP18MN	p.177
LQW03AW	p.179
LQW04AN	p.181
LQW15AN	p.184
LQW18AN	p.199
LQW21HN	p.221
LQW2BAS	p.213
LQW2BHN	p.209
LQW2UAS	p.216
LQW31HN	p.219

Introduction of Chip Inductors Web Site



Please check out Murata's newsletter!
 Have fun while learning about electronic components.
http://www.murata.com/products/emicon_fun/

EMICON-FUN! is disseminated widely from basics (principles, characteristics, mounting, etc.) of capacitors, EMI suppression filters and inductors to information that can be used practically.
 Updated information is also distributed via the mail magazine.

Click here to register as reader → <https://fofa.jp/murata/a.p/107/>

You can register from Murata Manufacturing Web site page TOP.
<http://www.murata.com/products/>



← This banner is the entrance of register form

email Magazine: Have fun while learning about electronic components

EMICON-FUN! Wide range of information about capacitors, noise suppression filters, and inductors.

Murata Newsletter
 EMICON-FUN! also available.
 Click here to register and download

Enter keywords to be searched Search

Capacitor Room

- Why does the electrostatic capacitance increase as the thickness decreases?
- Next-generation characteristics of capacitors and measurement methods
- What are impedance? ESR frequency characteristics in capacitors?
- The voltage characteristics of electrostatic capacitance
- The temperature characteristics of electrostatic capacitance

Noise suppression filter Room

- How can the mounting area be reduced? -Methods of using low-ESL capacitors-
- Associate of monolithic ferrite bead development: Horizontally-wound-type ferrite beads that support GHz frequencies
- The secret story behind the birth of chip ferrite beads (part 1/2)
- The secret story behind the birth of chip ferrite beads (part 2/2)
- What is inrush current?

Inductor Room

- Associate of inductor development [No. 4] Japan's first air-core horizontal wire-wound coil
- Associate of inductor development [No. 3] The LQP series realized super tight tolerance by thinning
- Why second-generation film-type inductors are incredible!
- Associate of inductor development [No. 2] Birth of the first film-type inductor: the "LQP31A series"
- (Inductor Applied Products) Chapter 3: "What are Dividers and Couplers?"

For the earth

- Special Feature on the Environment, Part 3 "Toward a Low-carbon Society - Initiatives for Global Warming Prevention"
- Special Feature on the Environment, Part II "Murata's Waste Management System"
- Environmental Packaging Materials

email Magazine: Have fun while learning about electronic components

EMICON-FUN!
 The index of Jan.28 issue

- Inductor Room
- Product News
- Proposal of New Tape Packaging
- Course for Noise Suppression against LTE Noise (3rd)

Expertly written articles explain the basics of capacitors, inductors and EMI suppression filters.

Inductor Room

Why second-generation film-type inductors are incredible!

The film-type inductor (LQP series) products are becoming increasingly smaller, but the main market for high-frequency inductors is currently the 0603 (in mm) / 0201 (in inch) size (0.6 x 0.3 mm). Murata components are also used in compact mobile devices such as smartphones. We would like to introduce the history and features of the LQP031N_02 series as a representative example.
http://www.murata.com/products/emicon_fun/2013/01/inductor_en28.html

Product News

-Common Mode Choke Coil (Film Type)
 <DLPONS Series>

- Small size and tight dimensional tolerance
 Size: 0.85x0.65x0.45mm

△Note • Please read rating and ⚠CAUTION (for storage, operating, rating, soldering, mounting and handling) in this catalog to prevent smoking and/or burning, etc.
 • This catalog has only typical specifications. Therefore, please approve our product specifications or transact the approval sheet for product specifications before ordering.

Products Information

Chip Inductors product information page has been drastically updated.

inductor murata Search <http://www.murata.com/products/inductor/>

- ▶ **Point 1**
The product search engine has been replaced by powerful one!
- ▶ **Point 2**
New contents such as inductors selection guide, products recommendation for each application has been added.
- ▶ **Point 3**
Inductors are classified into high frequency inductors and power inductors.

Inductors (Coils)

Search for Inductors (for high frequency, power lines, general purpose) Characteristics data can be downloaded from search result.

1 Search in the lineups
2 Search by specifications
3 Search by competitor's part number
4 Search by part number

Supporting your product development by the technology of Murata.

RF Inductors LQW15AN_80 Series
Inductors for Power Lines LQH5BPB_T0 Series

RF Inductors TOP Inductors for Power Lines TOP

Advantages of Murata Inductors

Knowledge of Inductor

Inquiries

Frequently Asked Questions (FAQ)

The top page is divided.

Inductors for Power Lines (Coils)

New Product Information

RF Inductors (Coils)

Design Tools

Search for Inductors (for high frequency, power lines, general purpose)

Application Examples

Examples of Problem Solving

Advantages of Murata Inductors

Knowledge of Inductor

Frequently Asked Questions (FAQ)

Recommended contents

You can see product data from various viewpoint

1 Search in the lineups
Search product in product series lineup list.

2 Search by specifications
Search product with specifications such as inductance value, rated current or dimension.

3 Search by competitor's part number
Search Murata's alternative product specifying other vender's part numbers.

4 Search by part number
Search product specifying Murata's part numbers.

Explain about inductors from basic to practice

Design assistance tools such as characteristics viewers and simulation libraries

Frequently Asked Questions (FAQ)

Shows selection guides of Murata inductors, recommended products to each application.

△Note • Please read rating and △CAUTION (for storage, operating, rating, soldering, mounting and handling) in this catalog to prevent smoking and/or burning, etc.
• This catalog has only typical specifications. Therefore, please approve our product specifications or transact the approval sheet for product specifications before ordering.

△Note • Please read rating and △CAUTION (for storage, operating, rating, soldering, mounting and handling) in this catalog to prevent smoking and/or burning, etc.
• This catalog has only typical specifications. Therefore, please approve our product specifications or transact the approval sheet for product specifications before ordering.

⚠ Note:

1. Export Control

<For customers outside Japan>

No Murata products should be used or sold, through any channels, for use in the design, development, production, utilization, maintenance or operation of, or otherwise contribution to (1) any weapons (Weapons of Mass Destruction [nuclear, chemical or biological weapons or missiles] or conventional weapons) or (2) goods or systems specially designed or intended for military end-use or utilization by military end-users.

<For customers in Japan>

For products which are controlled items subject to the "Foreign Exchange and Foreign Trade Law" of Japan, the export license specified by the law is required for export.

2. Please contact our sales representatives or product engineers before using the products in this catalog for the applications listed below, which require especially high reliability for the prevention of defects which might directly damage a third party's life, body or property, or when one of our products is intended for use in applications other than those specified in this catalog.

- | | |
|-----------------------------|--|
| ① Aircraft equipment | ② Aerospace equipment |
| ③ Undersea equipment | ④ Power plant equipment |
| ⑤ Medical equipment | ⑥ Transportation equipment (vehicles, trains, ships, etc.) |
| ⑦ Traffic signal equipment | ⑧ Disaster prevention / crime prevention equipment |
| ⑨ Data-processing equipment | ⑩ Application of similar complexity and/or reliability requirements to the applications listed above |

3. Product specifications in this catalog are as of September 2013. They are subject to change or our products in it may be discontinued without advance notice.

Please check with our sales representatives or product engineers before ordering. If there are any questions, please contact our sales representatives or product engineers.

4. Please read rating and ⚠ CAUTION (for storage, operating, rating, soldering, mounting and handling) in this catalog to prevent smoking and/or burning, etc.

5. This catalog has only typical specifications. Therefore, please approve our product specifications or transact the approval sheet for product specifications before ordering.

6. Please note that unless otherwise specified, we shall assume no responsibility whatsoever for any conflict or dispute that may occur in connection with the effect of our and/or a third party's intellectual property rights and other related rights in consideration of your use of our products and/or information described or contained in our catalogs. In this connection, no representation shall be made to the effect that any third parties are authorized to use the rights mentioned above under licenses without our consent.

7. No ozone depleting substances (ODS) under the Montreal Protocol are used in our manufacturing process.



<http://www.murata.com/>

Head Office

1-10-1, Higashi Kotari, Nagaokakyo-shi, Kyoto 617-8555, Japan
Phone: 81-75-951-9111

International Division

3-29-12, Shibuya, Shibuya-ku, Tokyo 150-0002, Japan
Phone: 81-3-5469-6123 Fax: 81-3-5469-6155 E-mail: intl@murata.co.jp

Cat. No. O05E-25

Mouser Electronics

Authorized Distributor

Click to View Pricing, Inventory, Delivery & Lifecycle Information:

Murata:

[LQG15HN15NJ00D](#) [LQG15HN1N5S00D](#) [LQG15HN4N7S00D](#) [LQG18HN47NJ00D](#) [LQG18HN5N6S00D](#)
[LQG18HN6N8J00D](#) [LQG18HN8N2J00D](#) [LQG18HNR10J00D](#) [LQG10A18NJ00T1](#) [LQG15HN10NJ00D](#)
[LQG15HN10NJ02D](#) [LQG15HN12NJ00D](#) [LQG15HN12NJ02D](#) [LQG15HN15NJ02D](#) [LQG15HN18NJ00D](#)
[LQG15HN18NJ02D](#) [LQG15HN1N0S02D](#) [LQG15HN1N1S02D](#) [LQG15HN1N2S00D](#) [LQG15HN1N2S02D](#)
[LQG15HN1N3S02D](#) [LQG15HN1N5S02D](#) [LQG15HN1N6S02D](#) [LQG15HN1N8S00D](#) [LQG15HN1N8S02D](#)
[LQG15HN22NJ00D](#) [LQG15HN22NJ02D](#) [LQG15HN27NJ00D](#) [LQG15HN27NJ02D](#) [LQG15HN2N0S02D](#)
[LQG15HN2N2S00D](#) [LQG15HN2N2S02D](#) [LQG15HN2N4S02D](#) [LQG15HN2N7S00D](#) [LQG15HN2N7S02D](#)
[LQG15HN33NJ00D](#) [LQG15HN33NJ02D](#) [LQG15HN39NJ02D](#) [LQG15HN3N0S02D](#) [LQG15HN3N3S00D](#)
[LQG15HN3N3S02D](#) [LQG15HN3N6S02D](#) [LQG15HN3N9S00D](#) [LQG15HN3N9S02D](#) [LQG15HN47NJ02D](#)
[LQG15HN4N3S02D](#) [LQG15HN4N7S02D](#) [LQG15HN56NJ02D](#) [LQG15HN5N1S02D](#) [LQG15HN5N6S00D](#)
[LQG15HN5N6S02D](#) [LQG15HN68NJ00D](#) [LQG15HN68NJ02D](#) [LQG15HN6N2S02D](#) [LQG15HN6N8J00D](#)
[LQG15HN6N8J02D](#) [LQG15HN7N5J02D](#) [LQG15HN82NJ02D](#) [LQG15HN8N2J00D](#) [LQG15HN8N2J02D](#)
[LQG15HN9N1J02D](#) [LQG15HNR10J02D](#) [LQG15HNR12J02D](#) [LQG15HS10NJ02D](#) [LQG15HS12NJ02D](#)
[LQG15HS15NJ02D](#) [LQG15HS18NJ02D](#) [LQG15HS1N0S02D](#) [LQG15HS1N2S02D](#) [LQG15HS1N5S02D](#)
[LQG15HS1N8S02D](#) [LQG15HS22NJ02D](#) [LQG15HS27NJ02D](#) [LQG15HS2N2S02D](#) [LQG15HS2N7S02D](#)
[LQG15HS33NJ02D](#) [LQG15HS39NJ02D](#) [LQG15HS3N3S02D](#) [LQG15HS3N9S02D](#) [LQG15HS47NJ02D](#)
[LQG15HS4N7S02D](#) [LQG15HS56NJ02D](#) [LQG15HS5N6S02D](#) [LQG15HS68NJ02D](#) [LQG15HS6N2S02D](#)
[LQG15HS6N8J02D](#) [LQG15HS82NJ02D](#) [LQG15HS8N2J02D](#) [LQG15HSR10J02D](#) [LQG15HSR12J02D](#)
[LQG15HSR15J02D](#) [LQG15HSR18J02D](#) [LQG15HSR22J02D](#) [LQG15HSR27J02D](#) [LQG18HN10NJ00D](#)
[LQG18HN12NJ00D](#) [LQG18HN15NJ00D](#) [LQG18HN18NJ00D](#) [LQG18HN1N2S00D](#) [LQG18HN1N5S00D](#)